

**Honeywell**

# ScanPal™ EDA57

Mobile Computer  
powered by Android™



---

**User Guide**

---

# Disclaimer

Honeywell International Inc. (“HII”) reserves the right to make changes in specifications and other information contained in this document without prior notice, and the reader should in all cases consult HII to determine whether any such changes have been made. HII makes no representation or warranties regarding the information provided in this publication.

HII shall not be liable for technical or editorial errors or omissions contained herein; nor for incidental or consequential damages resulting from the furnishing, performance, or use of this material. HII disclaims all responsibility for the selection and use of software and/or hardware to achieve intended results.

This document contains proprietary information that is protected by copyright. All rights are reserved. No part of this document may be photocopied, reproduced, or translated into another language without the prior written consent of HII.

Copyright © 2023 Honeywell Group of Companies. All rights reserved.

Web Address: [sps.honeywell.com](https://sps.honeywell.com)

# Trademarks

Google, Android, Google Play, Google Pay and other marks are trademarks of Google LLC

Bluetooth trademarks are owned by Bluetooth SIG, Inc., U.S.A. and licensed to Honeywell.

Other product names or marks mentioned in this document may be trademarks or registered trademarks of other companies and are the property of their respective owners.

# Patents

For patent information, refer to [www.hsmpats.com](https://www.hsmpats.com).

# TABLE OF CONTENTS

Customer Support .....	ix
Technical Assistance .....	ix
Product Service and Repair .....	ix
Limited Warranty .....	ix
<b>Chapter 1 - About the Computer Features.....</b>	<b>1</b>
About the Mobile Computer.....	1
EDA57 Model Overview.....	2
Mobile Computer Features .....	3
About the Battery .....	4
Battery Part Numbers .....	5
Charge the Battery Before Use.....	5
Battery Replacement.....	6
Replace the Battery.....	6
About the Battery Status.....	9
About the Battery Status LED Setting.....	10
Check the Battery Level and Usage .....	11
About Battery Life and Conservation .....	11
Battery Recommendations and Safety Precautions .....	12
Power On the Computer .....	13
Welcome Screen.....	13
Unlock the Screen .....	14
Change the Screen Lock to Protect the Computer .....	14
Configure the Screen Backlight .....	14
About the Good Read LED .....	15

About the Audio Features .....	15
Adjust Speaker Volume .....	15
Enable Vibrate Mode.....	16
Audio Settings .....	16
Insert a microSD Card.....	17
How to Transfer Files.....	18
Configure USB Connection and Transfer Files .....	19
Accessories for the Computer.....	19

## **Chapter 2 - About the User Interface and Applications..... 21**

About the User Interface.....	21
Navigation and Function Buttons .....	22
Remap a Button .....	23
Restore Default Button Action .....	24
About Status Bar Icons .....	24
View and Manage Notifications .....	25
Open Quick Settings .....	25
Customize the Home Screen .....	25
Customize the Favorites Tray .....	26
Use Google™ Search.....	26
About Screen Gestures .....	26
Set the Time Zone.....	27
About Honeywell Applications.....	28
Applications You Can Download to the Mobile Computer .....	29
Unlock Developer Options .....	31

## **Chapter 3 - Use the Imager..... 33**

About the Imager .....	33
About the Scan Wedge Feature .....	33
Change the Scanner Settings .....	34
Change the Bluetooth Scanner Settings .....	34
Restore Default Scan Settings .....	35
Default Scan Settings.....	35

Add a Scan Setting Profile.....	41
Delete a Scan Setting Profile .....	42
About ScanHandle Settings.....	42
About the Optional Digital Scan Button .....	42
Enable and Configure the Digital Scan Button .....	42
Scan Barcodes.....	43
About Scanning Configuration Barcodes.....	43
Use the Scan Demo App .....	44
Change the Scan Demo Symbology Settings .....	44

## **Chapter 4 - Use the Phone.....45**

About the Phone.....	45
Activate the Phone.....	45
Provision nano-SIM Card .....	46
Make a Phone Call.....	46
Answer the Phone .....	47
Switch Apps During a Phone Call.....	47
Make an Emergency Phone Call.....	48
Configure Phone Settings .....	48

## **Chapter 5 - Use the Camera .....49**

About the Color Camera .....	49
How to Zoom .....	49
Take a Photo.....	49
Record a Video.....	50
Change Camera Settings.....	51
Use the Camera as a Flashlight .....	51

## **Chapter 6 - Configure the Computer .....53**

How to Configure the Computer.....	53
Start the Settings App.....	53
About the Structure of the Settings App .....	53
About Network Communications .....	64

Connect to a Wi-Fi Network .....	64
Honeywell Wi-Fi Settings .....	66
How to Connect to Virtual Private Networks .....	66
About Wireless Security.....	67
About Certificates .....	68
About Bluetooth Communications .....	69
Connect a Bluetooth Device .....	69
Rename the Computer and View File History .....	70
Rename or Unpair a Paired Device.....	70
About USB Communications .....	70
USB Troubleshooting.....	71
USB, Bluetooth, or Ethernet Tethering for Data Connection Sharing .....	71
Minimum requirements for USB Tethering .....	71
Set up and Connection .....	71
Minimum requirements for Bluetooth Tethering .....	72
Set up and Connection .....	72
Minimum requirements for Ethernet Tethering .....	72
Set up and Connection .....	72
About Near Field Communication (NFC) .....	72
Developer Information.....	73
About Provisioning Mode .....	73
Enable or Disable Provisioning Mode.....	74

## **Chapter 7 - Manage and Maintain the Computer..... 75**

About Software Updates .....	75
Software Downloads .....	75
About Transferring Files via USB Connection .....	76
Install Software Apps with AutoInstall .....	76
Optional microSD Card Method.....	77
About the Honeywell Upgrader.....	77
Install OTA Updates.....	77
Restart (Reboot) the Computer.....	79
About an Enterprise Data Reset.....	79

Before You Begin.....	79
Enterprise Data Reset the Computer.....	80
About a Full Factory Reset.....	80
Before You Begin.....	80
Full Factory Reset the Computer.....	81
Repairs.....	81
Maintenance.....	81
Clean the Computer.....	82

**Appendix A - Specifications .....83**

Computer Agency Information.....	83
Label Locations.....	83
Physical and Environmental Specifications.....	84
Imager Specifications.....	84
Barcode Symbologies.....	84
S0703-SR Standard Range Imager.....	85
S0703-SR Standard Range Imager Field of View/Resolution.....	86





# Customer Support

## Technical Assistance

Go to [sps.honeywell.com](https://sps.honeywell.com) and select Support to search our knowledge base for a solution or to log into the Technical Support portal.

## Product Service and Repair

Honeywell International Inc. provides service for all of its products through service centers throughout the world. Go to [sps.honeywell.com](https://sps.honeywell.com) and select Support to find a service center near you or to get a Return Material Authorization number (RMA #) before returning a product.

For ongoing and future product quality improvement initiatives, the mobile computer comes equipped with an embedded device lifetime counter function. Honeywell may use the lifetime counter data for future statistical reliability analysis as well as ongoing quality, repair and service purposes.

## Limited Warranty

For warranty information, go to [sps.honeywell.com](https://sps.honeywell.com) and select **Support > Warranties**.



# ABOUT THE COMPUTER FEATURES

This chapter introduces the ScanPal™ EDA57 mobile computer. Use this chapter to learn about the basic computer features, functions, and accessories.

**Note:** *The EDA57 is available in two versions based on the I/O Connector type: a six-pin connector or a two-pin connector with a USB-C port. Throughout this manual, all versions of the mobile computer are referred to as the EDA57 unless information is specific to a particular model. The device applications and settings vary by computer model and OS version. Your computer may not include all the features shown in the manual.*

## About the Mobile Computer

The ScanPal EDA57 mobile computer delivers real-time connectivity, advanced data capture, and future-proof investment protection. All EDA57 models come equipped for fast Wi-Fi connectivity and Bluetooth (v5.1) technology that includes Bluetooth Low Energy (BLE) support.

EDA57-1 models provide additional connectivity with a Wireless Wide Area Network (WWAN) radio for high-speed data and quality voice support across all network technologies. EDA57 WWAN models also include an integrated global positioning satellite (GPS) receiver that supports GPS protocols including simultaneous GNSS Receiver Support for GPS, GLONASS, Galileo, and BeiDou.

To learn more about the EDA57 mobile computer, refer to the [EDA57 Model Overview](#) on page 2.

**Note:** *To learn more, see [Appendix A: Specifications](#), beginning on page 83.*

# EDA57 Model Overview

Available Features	Model EDA57-1
Android operating system*	x
Qualcomm Snapdragon SM4350Pro, 2.2 GHz processor	x
Memory options are dependent on model and scan engine type. <ul style="list-style-type: none"> <li>• 4GB DDR4 RAM, 64 GB flash memory</li> <li>• 6GB DDR4 RAM, 128 GB flash memory</li> <li>• 8GB DDR4 RAM, 128 GB flash memory</li> </ul>	x
Honeywell S0703-SR Standard Range Imager	x
USB Type C connector for communication/charging/headset (two-pin models only)	x
High-tier rugged specifications with IP67sealing	x
WLAN IEEE 802.11 a/b/g/n/ac radio; Wi-Fi certified	x
Bluetooth™ V5.1 and Bluetooth Low Energy wireless technology support	x
NFC technology for short-range wireless data exchange	x
WWAN radio for high speed data and quality voice support across all network technologies	x
Integrated GPS receiver; GPS protocol support for L1 bands that include Simultaneous GNSS Receiver Support for GPS, GLONASS, Galileo, and Beidou	x
Customer-accessible microSD™ slot for removable memory cards up to 128 GB (SDXC/SDHC/SDIO-compliant)	x
16-megapixel color camera with video, image stabilization and advanced software features for enhanced exposure control	x
8-megapixel front-facing camera	x
Value-added software components supporting specialized imaging and OCR functions	x
Large, high definition resolution (1440 x720 and 1080 x 2160 available), bright color, outdoor-readable display with responsive multi-touch capacitive touch panel**	x
Integrated Ambient light sensor, proximity sensor, accelerometer, hall sensor.	x

\* For information on supported Android OS versions, see the EDA57 Data Sheet, available at [sps.honeywell.com](https://sps.honeywell.com).

\*\* Use of a screen protector may have a small effect on the capacitive touch panel performance.

**Note:** To learn more, see [Appendix A: Specifications](#), beginning on page 83.

# Mobile Computer Features

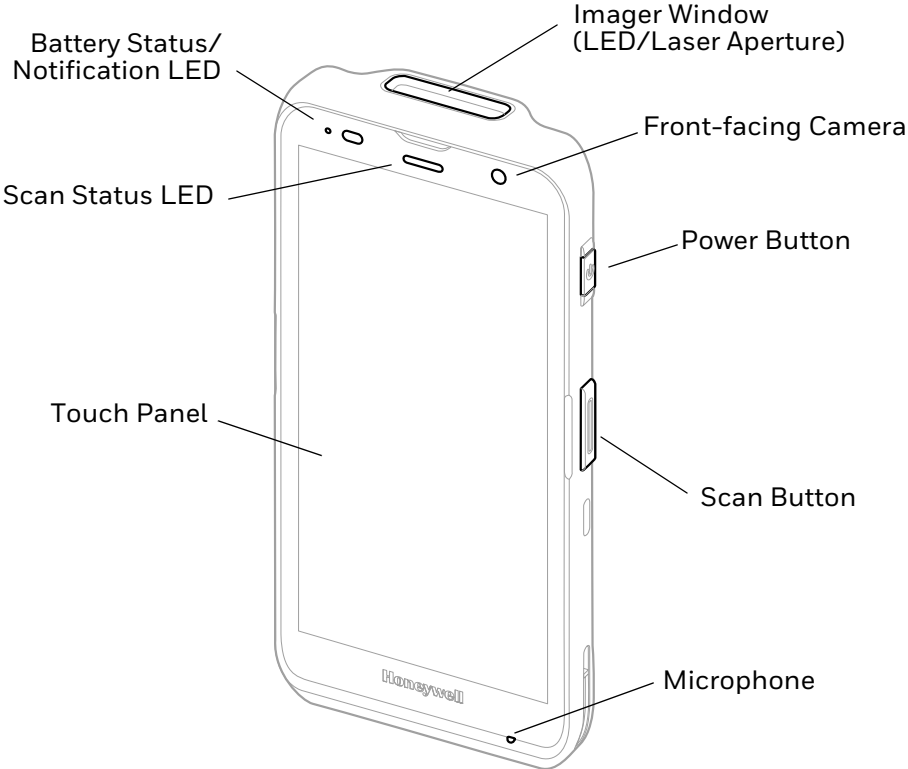

**Note:** Hand strap not shown.

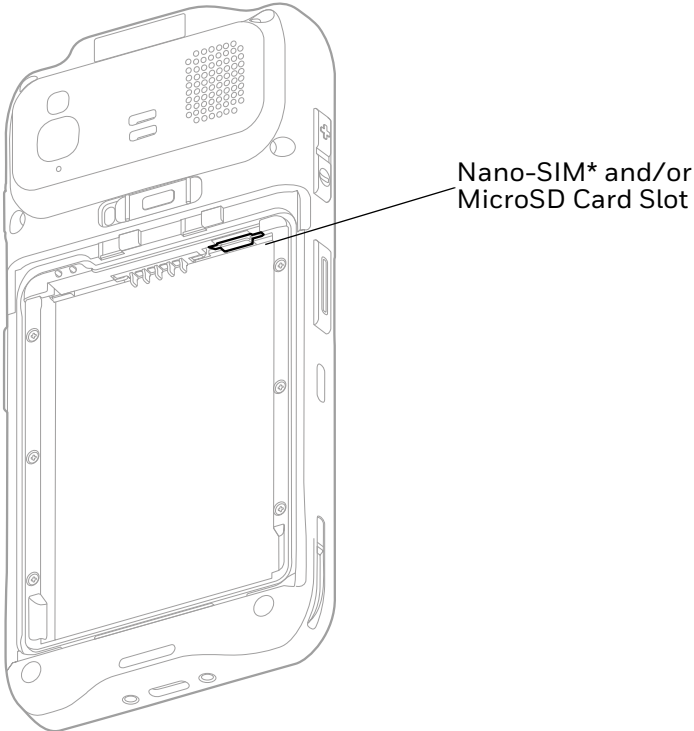

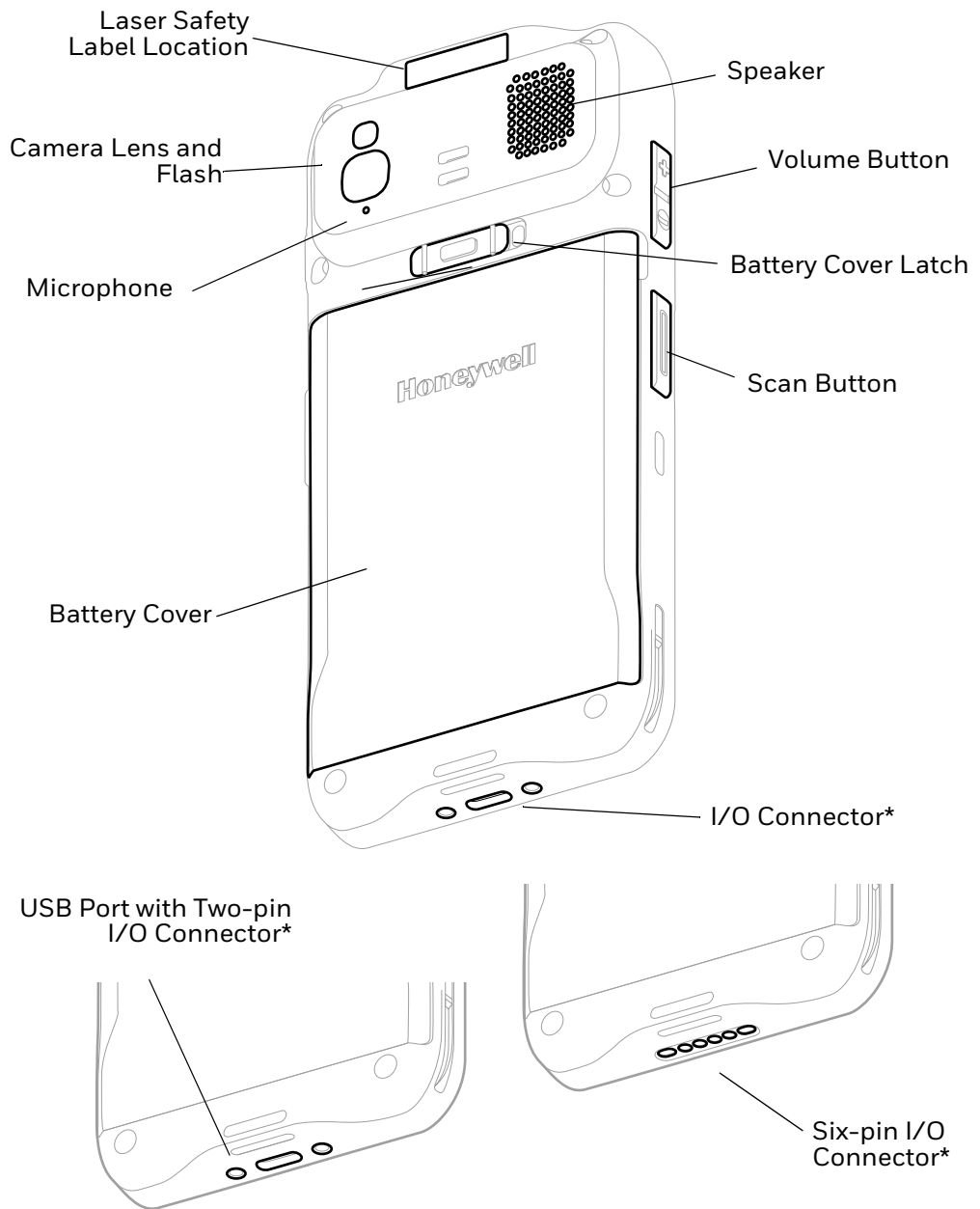

\* I/O Connector will be Six-pin or Two-pin with a USB port depending on the mobile computer model.

## About the Battery

The computer uses a rechargeable Li-ion battery as its main power source. Several factors determine the life of the battery, such as display brightness, display timeout, input device, extreme temperature, and battery usage. Honeywell recommends that you keep the battery charged at all times to prevent data loss.

EDA57 computers are designed for use with battery model BAT-EDA52 manufactured for Honeywell International Inc. **When ordering a replacement battery, it is important to order by part number and not only by model number.** See [Battery Part Numbers](#) on page 5 for guidance on the correct battery part number for your unit configuration.

For a list of compatible accessories, see the *EDA52 Accessory Guide*, available for download from the product device pages at [sps.honeywell.com](https://sps.honeywell.com). Contact your local sales representative for replacement battery ordering information.



**Caution:** Improper battery replacement or incompatible device usage may result in risk of burns, fire, explosion, or other hazard. Dispose of lithium-ion batteries according to local regulations. Risk of fire and burns if improperly handled. Do not open, crush, heat above 60°C (140°F), or incinerate.

## Battery Part Numbers

### EDA57 Models

Battery Model Number	Battery Part Number
BAT-EDA52	50172021-001



**Caution:** Read [Battery Recommendations and Safety Precautions](#) on page 12 and all cautionary markings on the battery, charging peripheral, and device using the battery before attempting to install, use, or charge the battery.

## Charge the Battery Before Use

The mobile computer ships with a partially charged battery. Charge the battery with an EDA52 charging device for a minimum of **3.5 hours**.

**Note:** Using the computer while charging the battery increases the time required to reach a full charge.

## About the USB Type C Connector

On EDA57 models equipped with a USB port, you can use a USB cable to charge the mobile computer from a host device (e.g., laptop or desktop computer). The connected host device must supply a minimum power output of 5V, 0.5A to the mobile computer.

**Note:** If the mobile computer is drawing more current than supplied by the charging source, charging will not take place.

# Battery Replacement

If your battery power is low, you need to either charge the battery in the computer or replace it with a charged battery.

## Replace the Battery



**Caution:** Improper battery replacement or incompatible device usage may result in risk of burns, fire, explosion, or other hazard. Dispose of lithium-ion batteries according to local regulations. Risk of fire and burns if improperly handled. Do not open, crush, heat above 60°C (140°F), or incinerate.

## Remove the Battery

1. Press and hold the **Power** button until the options menu appears.
2. Tap **Power off**.
3. Release the hand strap.

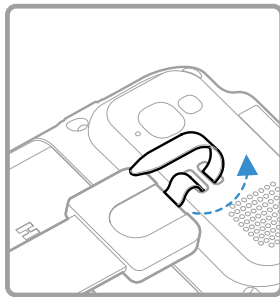

4. Unlock the battery cover. Press and hold down the small button on the battery latch and then slide the latch to the right.

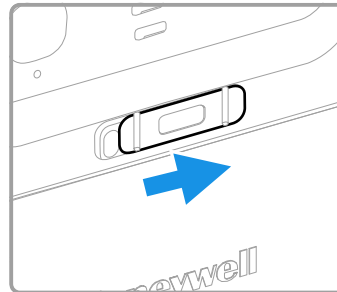
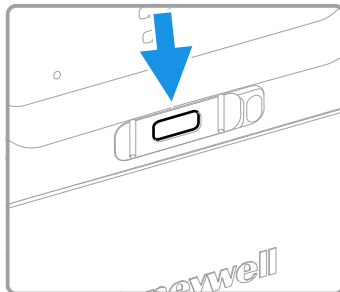



5. Lift the battery cover and remove it.

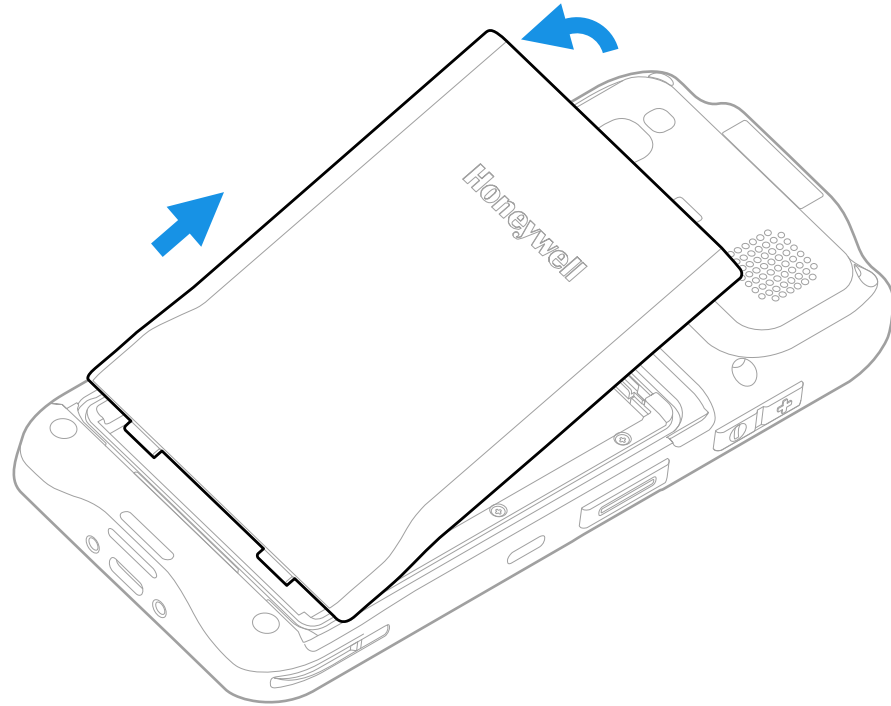

6. Use the tabs on the bottom of the battery to lift and remove it from the computer.

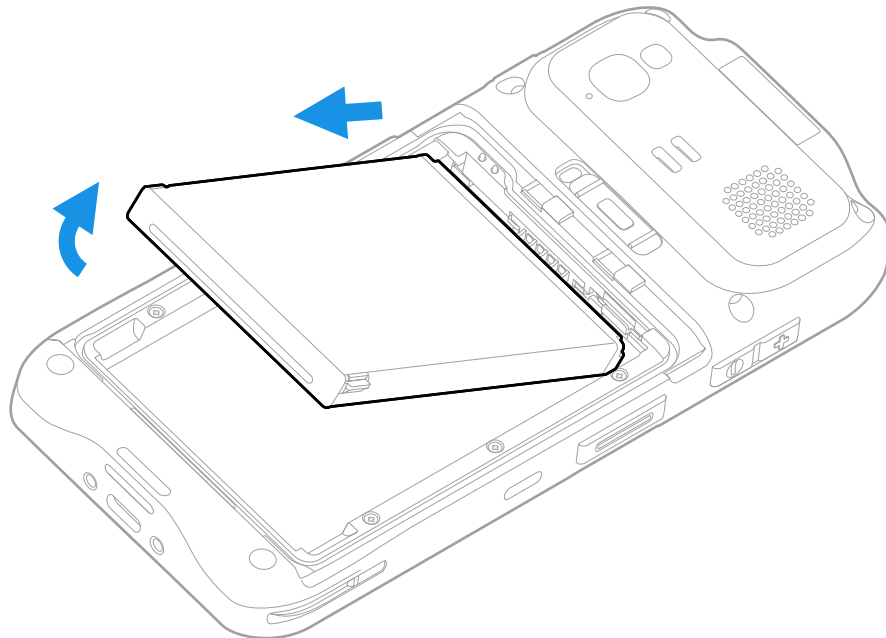

# Install the Battery

1. Insert the charged battery into the computer. The top of the battery must go in first to connect the pins. See [Battery Part Numbers](#) on page 5.

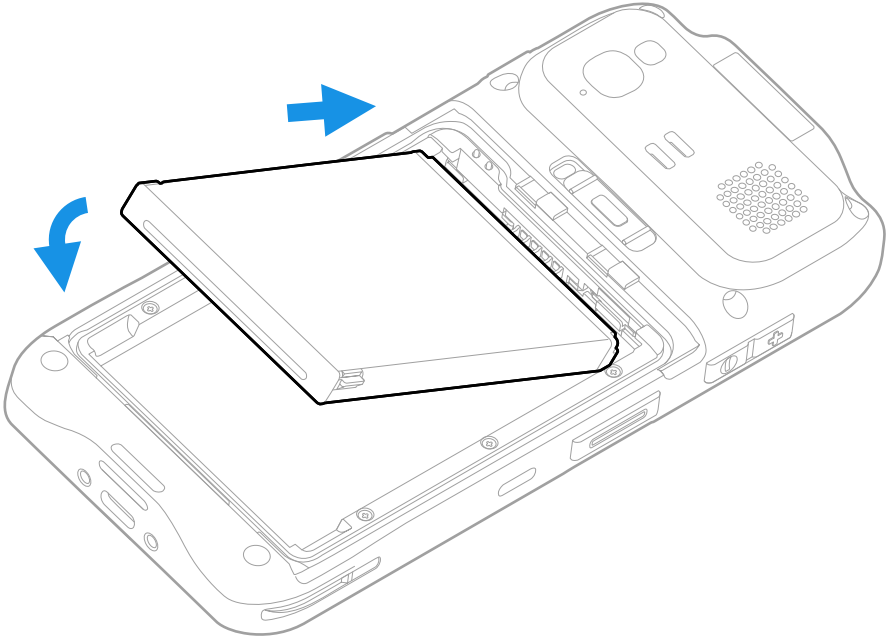

2. Insert the battery cover into the computer.

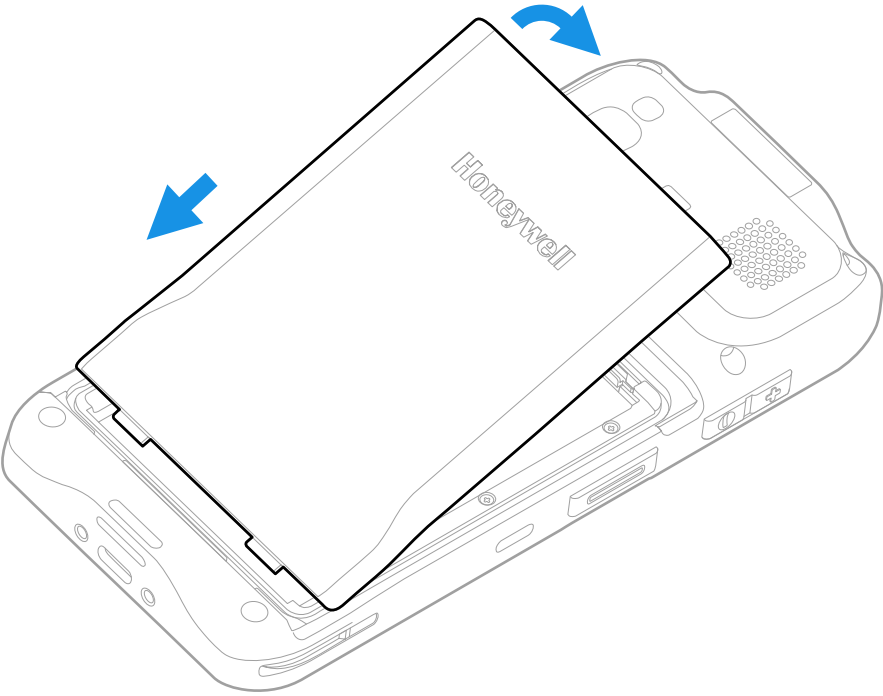

3. Slide the battery latch to the left.

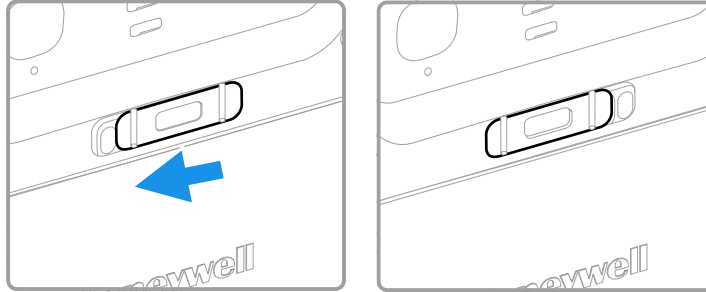

4. Attach the hand strap.

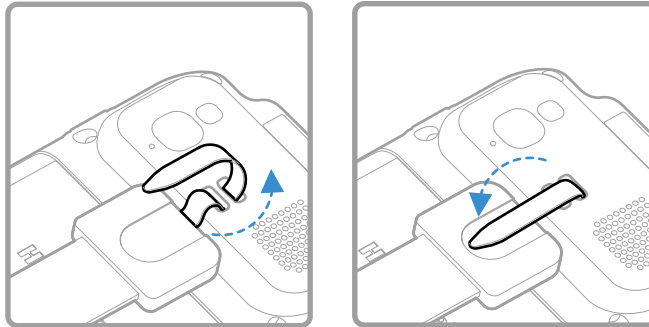







5. Press the **Power** button.

## About the Battery Status

Use the battery icon in the Status bar at the top of the screen to see the charge level of your battery. If you want more detailed information on your battery, such as usage time or charge remaining on the battery, open the **Settings** app and tap **Battery**.

### Battery Status Icons

Icon	Status
	The battery charge is at 100%.
	The battery charge is at 50%.
	The battery charge is low. You need to charge or replace the battery soon.
	The battery is critically low. You need to replace the battery now or connect the computer to a charging accessory.
	The computer is connected to external power and the battery is charging.
	There is a battery error. Install another battery. If the problem persists, call Honeywell Technical Support.

The Battery status LED color and behavior (e.g., steady on, blinking, or off) indicates the charging status of the battery. To view status descriptions and to learn how to modify the Battery LED behavior, see [About the Battery Status LED Setting](#) on page 10.

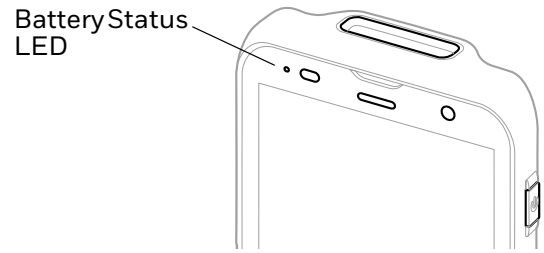

## About the Battery Status LED Setting

You can change the behavior of the Battery status LED if the out-of-box behavior for a charging battery (blinking green) is not acceptable to your environment.

You can choose one of three options:

- **Default Battery LED** (optional Android OS configuration)
- **Honeywell Battery LED** (factory default, out-of-box configuration)
- **No Battery LED**

### Honeywell Battery LED Behavior (Factory Default/Out-of-Box Configuration)

Connected to Power	LED State	Description
No	Blinking amber	Battery level is below 15%
No	Off	Battery level is more than 15%
Yes	Steady amber	Battery level is between 0% and 60%
Yes	Blinking green	Battery level is between 60% and 95%
Yes	Steady green	Battery level is above 95%
Either	Blinking red	Battery error

### Default Battery LED Behavior (Optional Android OS Configuration)

Connected to Power	LED State	Description
No	Blinking red	Battery level is below 15%
No	Off	Battery level is 15% or more
Yes	Steady red	Battery level is below 15%
Yes	Steady amber	Battery level is between 15% and 90%
Yes	Steady green	Battery level is 90% or more

Select the No Battery LED setting if you want to use the LED as a notification LED for applications or device management solutions. For more information on how to use the LED as a notification LED, see <http://developer.android.com/guide/topics/ui/notifiers/notifications.html>.

## Change the Battery Status LED Behavior

To change the battery status LED behavior:

1. Swipe up from the bottom of the Home screen to access all apps.
2. Tap **Settings**  > **Honeywell Settings** > **Battery LED**.
3. Choose one of the options:
  - **Default Battery LED** (optional Android OS configuration)
  - **Honeywell Battery LED** (factory default/out-of-box configuration)
  - **No Battery LED** (disable the battery LED)

## Check the Battery Level and Usage

In addition to the Battery status icon and LED, you can monitor the battery status from the Settings app.

1. Swipe up from the bottom of the Home screen to access all apps.
2. Tap **Settings**  > **Battery**.

The current percentage of battery power remaining and the amount of usage time left on the battery appears on the screen when the computer is not connected to an external power supply. When connected to an external power source, battery charge information is provided. A list shows the battery usage for individual apps and services. For usage details, select one of the apps or services in the list. You can also access the Battery saver feature from the battery screen.

## About Battery Life and Conservation

It is important to remember that the battery slowly discharges when stored over a long period of time even when the computer is turned off or the battery is stored outside the computer. Use the reference table below to learn about how to conserve battery power.

<b>When you want to:</b>	<b>Do this to save battery power:</b>
Use the computer but the low battery status icon appears or the battery light turns on.	Do one of the following: <ul style="list-style-type: none"><li>• Connect the computer to a charging accessory.</li><li>• <a href="#">Replace the Battery</a> (see page 6).</li></ul>
Stop using the computer for 5 minutes or more.	Make sure that the low battery status icon is not on the screen and that the battery status LED is not on. Press and release the <b>Power</b> button to suspend the computer.

When you want to:	Do this to save battery power:
Store the computer for more than a day.	<ul style="list-style-type: none"> <li>• If you are storing the computer for a few days (such as over the weekend), install a fully charged battery or connect the computer to a power source.</li> <li>• If you are storing the computer for a longer period of time, remove and charge the battery. When the battery is done charging, store both the battery and the computer in a cool location.</li> <li>• If you store the battery for several months, recharge the battery periodically to keep it at peak performance.</li> </ul>
Store the battery outside of the computer.	Store battery in charger or periodically recharge it to keep it at peak performance.

## Enable Airplane Mode

If you do not need to connect to any wireless networks, you can enable Airplane mode to turn off the radios and save battery power.

1. Swipe up from the bottom of the Home screen to access all apps.
2. Tap **Settings**  > **Network & internet**.
3. Tap the toggle button next to **Airplane mode**. An airplane icon appears in the status bar to indicate Airplane mode is turned on.

## Battery Recommendations and Safety Precautions



**Caution: Improper battery replacement or incompatible device usage may result in risk of burns, fire, explosion, or other hazard. Dispose of lithium-ion batteries according to local regulations. Risk of fire and burns if improperly handled. Do not open, crush, heat above 60°C (140°F), or incinerate.**

- To learn more about Battery Maintenance for Portable Devices, go to [honeywell.com/PSS-BatteryMaintenance](https://honeywell.com/PSS-BatteryMaintenance).
- For maximum battery life, charge the battery at 20 °C (68 °F) to 25 °C (77 °F) and store at 20 °C (68 °F) with a 30%-50% charge.
- Do not store the battery at temperatures above 60 °C (140 °F). Storage above 60 °C (140 °F) may damage the battery.
- Charge the battery before use. Battery ships with only a partial charge.
- See [Charge the Battery Before Use](#) on page 5 for approved charging methods. Use of this battery in other devices could result in damage to the device or battery.
- Avoid dropping the battery or computer. If you suspect that the battery or computer is damaged, send it to Honeywell service center for inspection.

- Replace the battery only with another BAT-EDA52 model battery that matches the part number noted in the [Battery Part Numbers](#) (see page 5) section of this guide. These batteries have been tested in accordance with applicable safety standards. Contact your Honeywell sales representative or distributor if this battery is no longer available.
- Discarded batteries may create a safety hazard. Before disposal, cover the battery contacts with electrical insulating tape.
- Do not modify the battery or attempt to insert foreign objects into it.
- Do not solder directly to the battery contacts.
- Do not drop the battery or apply mechanical shocks or pressure to it.
- Do not immerse batteries into, or expose them to, water or seawater.
- Do not incinerate, microwave, throw into a fire, or expose batteries to temperatures above the maximum rating.
- Do not disassemble a battery or try to open or penetrate its housing.

## Power On the Computer

After you have fully charged and installed a battery, power on the computer for the first time:

- Press and hold the **Power** button for approximately 3 seconds, and then release the button.

## Welcome Screen

The first time you power on the computer, a Welcome screen appears. You can either scan a configuration barcode or use the Wizard to manually set up the computer. To learn more about how to [Scan Barcodes](#), see page 43.

During the manual setup process, follow the prompts on the screen as the wizard has you:

- Set the default language.
- Set up the Wi-Fi network connections.
- Set the time, date, and time zone.
- Personalize (name) the computer.
- Set up security and privacy options.

Once you complete the initial setup, the Welcome screen no longer appears when you power on the computer and **Provisioning mode** is automatically turned Off (disabled). Scanning a barcode to install applications, certificates, configuration files, and licenses on the computer is restricted when **Provisioning mode** is turned Off. To learn more [About Provisioning Mode](#), see page 73.

# Unlock the Screen

The screen lock automatically activates every time the computer is turned On or when the computer wakes from Screen Timeout mode (sleep mode).

- Swipe up from the bottom of screen to open.

The level of security provided depends on the type of lock set (e.g., Swipe, Pattern, PIN, or Password). The default setting (Swipe) provides no protection against unauthorized access to your computer.

# Change the Screen Lock to Protect the Computer

After you start using the computer, you should change the screen lock to prevent unauthorized persons from accessing the computer after the screen lock activates, unless they input the correct password, pin, or pattern.

The recommended setting for the Screen Lock is to enable a Password lock. Use a strong password value (e.g., include numbers, characters, special characters, and mixed character case).

1. Swipe up from the bottom of the Home screen to access all apps.
2. Tap **Settings**  > **Security** > **Screen lock**.
3. Choose one of the following options:
  - **None**
  - **Swipe**
  - **Pattern**
  - **PIN**
  - **Password**
4. Follow the on-screen prompts to complete the setup.
5. Exit the Settings app.

# Configure the Screen Backlight

The display has an ambient light sensor that automatically adjusts the backlight intensity to conserve power and ensure the display is readable. You can also manually set the backlight intensity if you do not want to use the automated adaptive brightness feature.

1. Swipe up from the bottom of the Home screen to access all apps.
2. Tap **Settings** > **Display**.



3. Choose one of the following options:
  - To have the computer automatically adjust the brightness for your work environment, turn On the **Adaptive brightness** setting. You can tap **Adaptive brightness** to toggle the feature On or Off.
  - To set the brightness level manually, verify the Adaptive brightness feature is turned Off, and tap **Brightness level**. Adjust the slider to set the brightness level.

## About the Good Read LED

The Scan Status LED indicates the read status of the imager when scanning a barcode. When active, the LED illuminates below the front speaker. To learn more about how to use and configure the imager for scanning, see [Chapter 3: Use the Imager](#), beginning on page 33.

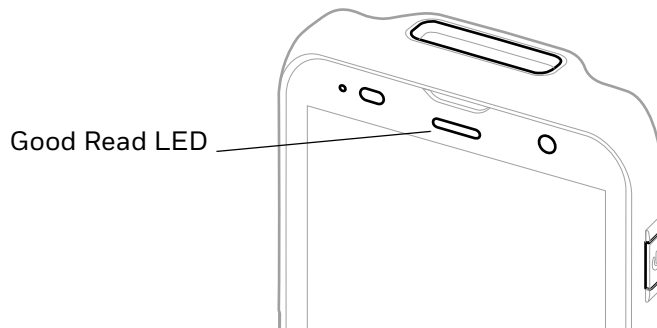

### Good Read LED Descriptions

LED Color	Description
Green	Good read of a barcode.
Blinking green	The data collection imager is processing or starting up.
Red	Failure to scan barcode. Check to make sure you have the correct symbology enabled.

## About the Audio Features

The EDA57 has multiple speakers, three microphones, and several software settings to configure sound volume or enable vibration feedback.

### Adjust Speaker Volume





Use the Volume buttons on the left side of the computer to adjust the volume of ringtones, media, notifications, and alarms.

**Note:** *The volume setting varies by OS version.*

To quickly change the active speaker volume level:

- Press the top of the Volume button (+) to raise the volume of the active speaker.
- Press the bottom of the Volume button (-) to lower the volume of the active speaker.

To access the volume quick set menu:

1. Press the Volume button.
2. Adjust the volume level using the on-screen menu.
  - Tap the icon at the top to toggle the media volume between Sound On , Vibrate Only , or Silent .
  - Use the slider to adjust the media volume.
  - Tap  to turn toggle media volume Off.
  - Select ●●● at the bottom to adjust Media, Call, Ring, or Alarm volume levels.

## Enable Vibrate Mode

Simultaneously press the **Volume up** (+) and **Power** buttons to quickly enable Vibrate mode so the computer vibrates instead of emitting sound for notifications and rings.

If you need quiet time without interruptions, enable Do Not Disturb to mute sound, stop vibration, and block notifications. Under the full settings menu, you can set a schedule for when you want Do Not Disturb to automatically turn on and off.

To enable Do Not Disturb manually:

1. Swipe down from the top of the screen to view quick set menu.
2. Tap the **Do Not Disturb** icon  to toggle feature On/Off.

## Audio Settings

This section describes the audio and sound settings you can configure in the Settings app.

- To change audio settings, open the **Settings**  app and then tap **Sound**.

## Sound Settings

Setting	Description
Media volume	Use the sliders to set the volume for media (e.g., music, videos, and games), calls, alarms, and rings (notifications and ringtones).
Call volume	
Ring & notification volume	
Alarm volume	
Do Not Disturb	Select to set which notifications to let through when you have Do Not Disturb turned On and when you want to be left alone.
Phone ringtone	Select a default ringtone.
Media	Select to show or hide media player when the media session has ended.
Vibrate for calls	Select to enable vibrate mode when the phone is ringing.
Shortcut to prevent ringing	Set what happens when you simultaneously press the Power and Volume up button. Options include: Vibrate, Mute, or turn the shortcut Off.
Default notification sound	Select a notification sound.
Default alarm sound	Select an alarm sound.
Other sounds and Vibrations	Turn sounds On or Off for: <ul style="list-style-type: none"><li>• Dial pad tones</li><li>• Screen locking sounds</li><li>• Charging sounds and vibration</li><li>• Touch sounds</li><li>• Touch vibration</li></ul>

## Insert a microSD Card

You can use a microSD card to increase file storage capacity or to install software. Honeywell recommends the use of Single Level Cell (SLC) industrial grade microSD or microSDHC memory cards with the computer for maximum performance and durability.

**Note:** *Format the memory card before initial use.*

1. Save your files and close any open applications.
2. Press and hold the **Power** button until the options menu appears.
3. Tap **Power Off**.
4. Remove the battery from the computer (see [page 6](#)).

5. Slide the card holder tray out of the slot.

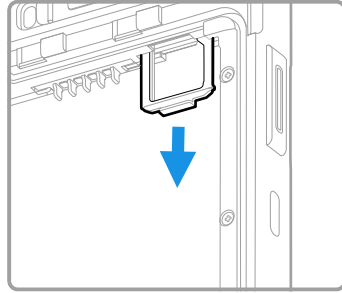

6. Turn the tray over, insert the microSD card into the tray with the contacts facing up, and then turn the tray over again.

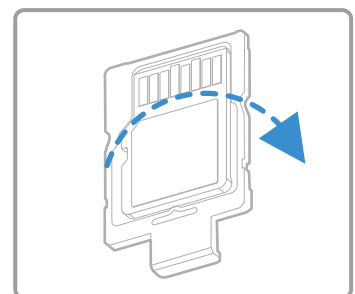
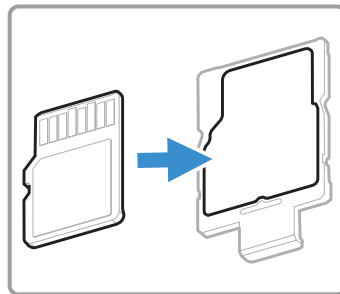
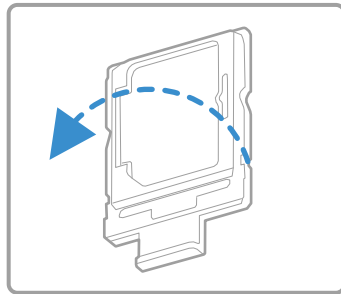

7. Slide the card holder tray back into the slot.
8. Install the battery (see [page 8](#)).

## How to Transfer Files

To transfer files, you can physically connect the mobile computer to your workstation (e.g., laptop or desktop computer) through a USB connection. When the mobile computer is connected and USB is configured for file or photo transfer, use a file browser (e.g., Windows® File Explorer) on your workstation to transfer files between the two computers. If you are transferring files to and from a Mac, use the Android File Transfer application (available from [www.android.com/filetransfer](http://www.android.com/filetransfer)).

**Note:** File transfer through a USB connection is disabled by default. You need to configure the USB connection for transferring files or photos.

You can use these accessories to connect your mobile computer to your workstation:

- Home Base or Ethernet Home Base, and a standard USB Type B to A cable.
- Snap-On Adapter, Tethered USB Cable Client (EDA52-SN-USB-0).
- A standard USB communication cable with Type C connector.

# Configure USB Connection and Transfer Files

**Note:** The EDA57 supports Hi-Speed USB communications (USB 3.0) with theoretical maximum data transfer rate of 5Gbps. USB on-the-go (OTG) supported.

1. Connect the mobile computer to your workstation.
2. On the mobile computer, swipe down from the top of the screen to see the notifications.
3. Tap the **Android System** notification twice to open the options menu. You may need to scroll down to the bottom of your notifications to find it.
4. Select either **File Transfer** or **PTP** (picture transfer protocol).
5. Open the file browser on your workstation.
6. Browse to the mobile computer. You can now copy, delete, or move files between the computer and your workstation.

## Accessories for the Computer

The computer ships with a partially discharged battery. All other accessories are ordered and shipped separately.

For a complete list of compatible accessories for your mobile computer and their part numbers see the *EDA52 Accessory Guide* available for download at [sps.honeywell.com](http://sps.honeywell.com).

Contact your local sales representative for ordering information.

Accessory	Description
Single Charging Dock (EDA50-HB-R)	Charging cradle for charging the ScanPal EDA57 (Compatible with EDA51 scan handle when used with Backwards Adapter: EDA52-ADC). Does not include charging cable; cable and power adapter plugs must be ordered separately.
Single Charging Dock (EDA52-HB-0, EDA52-HB-1, EDA52-HB-2, EDA52-HB-3, EDA52-HB-5)	Charging cradle for charging the ScanPal EDA57 and battery (Compatible with EDA57 scan handle).
Quad Battery Charger (EDA52-QBC-0, EDA52-QBC-1, EDA52-QBC-2, EDA52-QBC-3, EDA52-QBC-5)	Quad battery charger for charging the ScanPal EDA57 batteries. Kit contains power supply and power cord.
Quad Bay Charging Base (EDA52-CB-0, EDA52-CB-1, EDA52-CB-2, EDA52-CB-3)	Quad bay charging base for the ScanPal EDA57. Kit contains power supply and power cord. (Compatible with EDA57 scan handle).

Accessory	Description
Non-booted Net Base (EDA52-NB-UVN-0, EDA52-NB-UVN-2)	Non-booted Net base for Ethernet communications and recharging up to four computers. Kit includes net base and power cord. (Power cord included with EDA52-NB-UVN-2 only.)  * Net Base is for Six-Pin model only.
Non-booted Display Dock (EDA52-DB-UVN-0, EDA52-DB-UVN-2)	Non-booted Display Dock for recharging one computer, connection with an external display, extending I/O for HDMI, Ethernet communications. Kit includes Ethernet home base and power cord. (Power cord included with EDA52-DB-UVN-2 only.)  * Display Dock is for Six-Pin model only.
Scan handle (EDA52-SH-R)	Attach the scan handle to the the ScanPal EDA57 for easier grip and trigger action when scanning labels.
Hand strap (3012-0760-001)	Hand strap attaches to the ScanPal EDA57.
Wrist strap (EDA52-WS-10PK)	Wrist strap attaches to the ScanPal EDA57.
Screen film (EDA52-SP-10PK)	Screen film for the ScanPal EDA57.
Protective boot (EDA52-RB-0)	Rubber protective boot for the ScanPal EDA57.
Backwards adapter (EDA52-ADC)	Backwards adapter (2pin cup) to work with EDA50/51 accessories.
USB cup (EDA52-SN-USB-0)	Snap-on USB cup for standard USB port.  * USB cup is for Six-Pin model only.
Universal cup (EDA52-UCP-N)	Adapter cup to work with CT40 series universal docks.  * Universal cup is for Six-Pin model only.
RFID bracket (IH25-BR-5)	IH25 bracket for the ScanPal EDA57 terminal without rubber boot.
Power Adapter and Plugs (50130570-001)	Power adapter and plugs for ScanPal EDA50/EDA50hc/EDA50K/EDA51/EDA52/EDA56/EDA57. Includes US, EU, UK, and India plugs.

# ABOUT THE USER INTERFACE AND APPLICATIONS

Use this chapter to learn about the user interface and how to interact with the screen. You can also use this chapter to learn about the Honeywell applications on the computer.

## About the User Interface

The Android operating system provides a touch-friendly and easy-to-navigate user interface. When you turn on the mobile computer, the Home screen is the first screen that appears after language provisioning and the startup wizard is complete.

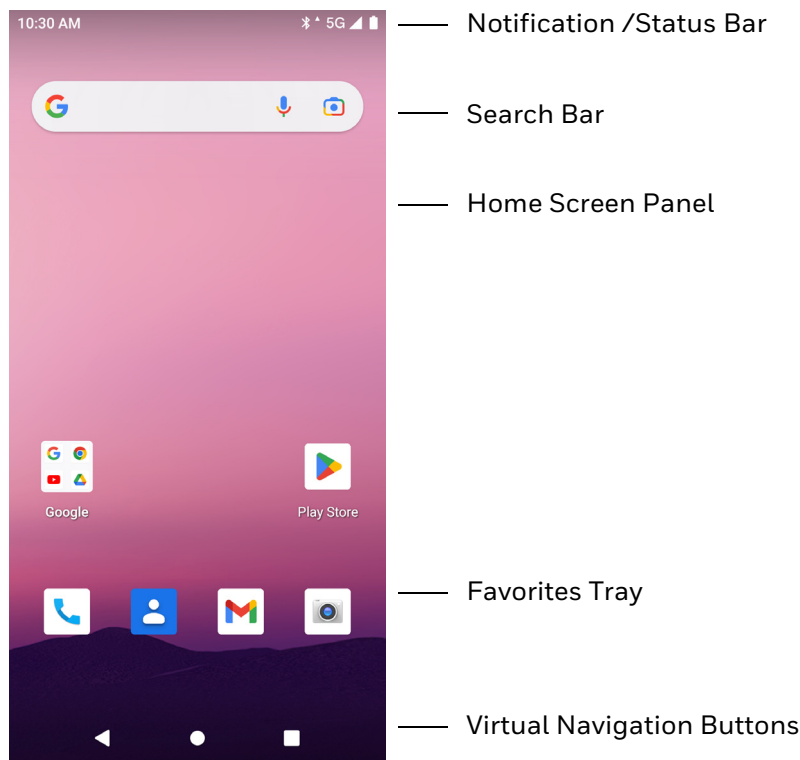

## Home Screen Features

Item	Description
Notifications panel / Status bar	Status icons to the left tell you when an app has sent notifications, such as an arriving message. System icons to the right display the current wireless and network connection state and battery level.
Search bar	Search the Internet or the computer using Google™. Tap the microphone icon in the search box to initiate a voice search or command.
Home Screen Panel	You can create more than one custom Home screen panel. Swipe left or right on the Home screen to switch between your custom panels.
Favorites tray	App icons in the customizable tray are visible on all Home screen panels.







## Navigation and Function Buttons

Your mobile computer has virtual buttons on the front panel below the Favorites tray and hardware buttons located on the sides for easy navigation and quick feature access when using the computer.

For button locations, see [Mobile Computer Features](#) on page 3.

To learn how to [Remap a Button](#), see [page 23](#).

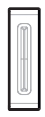
### Navigation and Function Button

Button	Description	
	Back	Tap to return to the previous screen.
	Home	Tap to return to the Home screen.
	Recent Apps	Tap to view and switch between recently used apps. The Screenshot button also appears when selected.
	Volume	Press the top of the <b>Volume</b> button to raise the speaker volume. Press the bottom of the <b>Volume</b> button to lower the speaker volume.
	Scan	Press the right or left <b>Scan</b> button to trigger the scanner.
	Power	<p>Press and release the <b>Power button</b> to activate or exit Screen Timeout mode (see <a href="#">page 57</a>).</p> <p>Press and hold the button for approximately 3 seconds, and then release to view the options menu.</p> <ul style="list-style-type: none"> <li>• <b>Power off</b> (see <a href="#">page 13</a>)</li> <li>• <b>Restart</b></li> <li>• <b>Emergency</b></li> </ul> <p>Perform a manual restart if touchscreen is unresponsive (see <a href="#">page 79</a>).</p>



# Remap a Button

You can change the default function of the Left Scan, Right Scan, Volume Up, and Volume Down buttons.

1. Swipe up from the bottom of the Home screen to access all apps.
2. Tap **Settings**  > **Honeywell Settings** > **Keyremap**.
3. Tap the plus sign (+).
4. Press the button you want to remap or select one of the virtual buttons.
5. Tap **OK**.
6. Select one of the following options:
  - Tap **Keys** to view available functions. Select the function you want assigned to the button.
  - Tap **Apps** to view available applications. Select the application you want assigned to the button.
  - Tap **Actions** to enter an Intent or Broadcast. Tap **OK** to assign the action to the button. For example, to start an Intent, type `com.android.settings/com.android.settings.wifi.WifiSettings`.
  - Tap **Command** to enter a command that will be executed when the button is pressed. This option supports all ADB shell commands. For example, if you choose a button to remap and enter the command `input keyevent 64`, pressing the selected button will open the web browser on the device.
  - Tap **Text** to type characters to display when the remapped key is pressed. Use a comma “,” to separate the characters. Tap **OK** to assign the text to the button. Examples are listed below:



Input Text	Button Press
A,A,B	aab
SHIFT_LEFT,A,SHIFT_LEFT,B or CAPS_LOCK,A,CAPS_LOCK,B	AB
SHIFT_LEFT,1	!
CTRL_LEFT,A	(Select All)
VOLUME_UP	(Volume Up)

**Note:** Lower case text is not supported in the **Text** field. Text must be entered in upper case. For example, “H,e,l,l,o” will display as “h”, whereas “H.E.L.L.O” will display as “hello”.

7. Tap **Keys** or **Applications** to view the available functions.
8. The function you selected now appears next to the button name.

## Restore Default Button Action

















To restore the button default action:

1. Swipe up from the bottom of the Home screen to access all apps.
2. Tap **Settings**  > **Honeywell Settings** > **Key Remap**.
3. Tap the clean icon .
4. Choose the remapped button(s) you want restored to the default setting.
  - Tap the check box next to the button.
- OR
  - Tap **All Select** to choose all the buttons.
5. Tap **Delete**.

## About Status Bar Icons

Status and notification icons show you the current status of your network, the battery, notifications, and sounds. Use the table below to understand some of the most common icons.

### Status and Notification Icons

Icon	Description	Icon	Description
	Pending alarm and Alarm is set.		Vibrate mode is turned on.
	Bluetooth is turned on.		Airplane mode is turned on.
	New text message or multimedia message.		Error with text or multimedia message delivery.
	New email.		SD card is full.
	Computer is connected to a PC with a USB cable.		Wi-Fi network connected with full signal strength.
	Synchronizing data.		Wi-Fi network connected but no signal strength.
	Error with sync or sign-in.		Computer is connected with Ethernet.
	Phone connected with full amount of bars.		Phone connected with full amount of bars but no Internet connection.

## View and Manage Notifications

You can view recent events on the computer, manage system notifications, change a setting, or quickly respond to an app notification by opening the notifications panel.

When a notification icon appears in the status bar at the top of the screen:

1. Swipe down from the top of the screen to open the notifications panel.
2. Respond to the notification. You can take one of the following actions:
  - Tap the notification to open the associated app.
  - Tap a quick-reply or action command (e.g., Reply, Archive) if available.
  - Swipe the notification sideways, off the screen to dismiss it. Note that some notifications cannot be dismissed.
  - Slide the notification left or right to reveal the settings icon . Choose between **Stop notifications** or **Keep showing**.

To close the notification panel, swipe up from the bottom of the screen, or tap the **Back** or **Home** buttons.

## Open Quick Settings

Use the Quick Settings screen to quickly access common settings. Tap an icon to toggle the feature On/Off or to open additional settings.

- To open Quick Settings swipe down once from the top of the screen. The most common settings are at the top of the screen. Swipe down again to expand Quick Settings. Once expanded, you can swipe right to left to view additional settings.
- To close Quick Settings, swipe up on the screen.

## Customize the Home Screen

You can add application icons to any Home screen for easier access.

1. Swipe up from the bottom of the Home screen to access all apps.
2. Tap and hold the app you want to add, and then move it slightly. The computer switches to a smaller view of the Home screen panels.
3. Drag and drop the app icon into place.
  - If you want to add another home screen, drag the icon to the right edge of the screen before releasing the icon.
  - If you want to create a folder, drag and drop the icon on top of another icon.

To add widgets or customize the look of the Home screen:

1. Tap and hold an empty section of the Home screen.
2. Select either **Wallpapers, Widgets, or Home Settings**.

## Customize the Favorites Tray

Modify the Favorites tray to contain the apps you use the most.

1. Tap and hold the app you want to replace on the Favorites tray, and then move it slightly.
2. Drag and drop the app on “**X Remove**” at the top of the screen if you want to discard it or simply move it out of the favorites tray to an empty section on the Home screen.
3. Swipe up from the bottom of the screen to access all apps.
4. Tap and hold the icon of the app you want to add, and then move it slightly.
5. Drag and drop the icon into position on the Favorites tray.

## Use Google™ Search

Use the Google Search field on the Home screen to help you find anything you need on the computer or on the web.

1. On the Home screen, tap inside the Google Search box and begin to type your search term.

As you type, suggestions from Google web search appear below the Search box, and results from the computer (such as apps or contacts) appear below the web search results.

2. Tap a suggestion to search for it immediately, or tap the arrow to add the term to the search field without starting to search.

## About Screen Gestures

Use your fingers or the stylus to manipulate icons, buttons, menus, the on-screen keyboard, and other items on the screen.

- **Tap**

Tap to select something, toggle a setting on or off, or activate a field for text entry. An on-screen keyboard automatically appears for text entry.

- **Tap and hold**

Tap and hold an item but do not lift your finger or stylus until an action occurs.

- **Drag and drop**

Tap and hold an item, and then slide your stylus or finger across the screen until you reach the target position. Lift your finger or stylus off the screen to drop the item in place.

- **Swipe**

Quickly move your finger across the screen, without pausing when you first touch the screen. For example, you can swipe a Home screen left or right to view the other Home screens.

- **Slide**

Slowly move your finger across the screen, without pausing when you first touch the screen. For example, you can slide a notification to the left until the Settings gear is revealed.

- **Double-tap**

Tap quickly twice on a web page, map, or other screen to zoom in. Double-tap again to zoom out.

- **Pinch**

In some apps, you can zoom in and out by placing two fingers on the screen at once and pinching them together (to zoom out) or spreading them apart (to zoom in).

## Set the Time Zone





The computer gets the current date and time from its network connection. If preferred, you can change this behavior and manually set the time zone for your location.









1. Swipe up from the bottom of the Home screen to access all apps.
2. Tap **Settings**  > **System** > **Date & time**.
3. To change the time, tap **Set time automatically** to turn off the feature.
  - a. Tap **Date** then select a date from the calendar and click **OK**.
  - b. Tap **Time** then use the clock to select a new time and click **OK**.
4. To change the time zone, tap **Set time zone automatically** to turn off the feature.
  - a. Tap **Time zone** and choose the time zone for your location.
  - b. Press the back arrow to return to the Date & time screen.
5. The Time Format defaults to **Use locale default**. Tap **Use 24-hour format** to change the time display.

# About Honeywell Applications

Honeywell applications help you troubleshoot and connect your computer to other devices and networks. Some of the applications in this table are located in the Power Tools app. To learn more about Honeywell Power Tools, go to [sps.honeywell.com](https://sps.honeywell.com) to download the *Power Tools User Guide*.

## Honeywell Applications Available on the Computer

Icon	Application	Description
	AutoInstall Settings	Enable the AutoInstall feature, to automatically install *.zip or *.apk files containing applications saved in the Internal shared storage\honeywell\autoinstall folder and IPSM card\honeywell\autoinstall folder on the computer during the power-up boot or reboot process.
	Demos	Honeywell Demo apps demonstrate the basic capabilities of the computer and are not intended as functional business solutions. The demos included, demonstrate scanning, signature capture, NFC functionality, and printing via Bluetooth technology. Information on how to create custom applications for your Honeywell mobile computer can be found in the Honeywell Software Development Kit (SDK) for Android, available from the <a href="#">Technical Support Downloads Portal</a> .
	Enterprise Settings	Enterprise Settings can help customers achieve some common customized needs. Support UI interface, SDK and Broadcast way.  Scan Settings <ul style="list-style-type: none"> <li>• Scan result broadcast action</li> <li>• Scan result broadcast key</li> <li>• Scan button key down broadcast</li> <li>• Scan button key up broadcast</li> </ul> General Settings <ul style="list-style-type: none"> <li>• Function Control</li> <li>• Function Restriction</li> <li>• Custom boot animation</li> <li>• Grant/Revoke runtime permissions</li> <li>• Set default launcher</li> </ul>
	HUpgrader	Use to the HUpgrader app to view the current OTA version on the computer, check for updates, or initiate an OTA upgrade from storage.
	HQ Config	HQConfig is used for offline rapid deployment. Synchronize content: common settings, scan settings, applications and firmware upgrades.

Icon	Application	Description
	HonRfid	When the computer is connected to a Honeywell RFID product, the HonRfid app is used to demonstrate the functions of Honeywell RFID products (e.g., inventory, RFID tag reading, writing and locking, power adjustment, frequency adjustment, etc.)
<b>Power Tools</b>		
	BattMon	BattMon provides information on the charge status and health of the battery, and provides access to activate battery status notifications and battery charging history logs.
	ConfigApps	The ConfigApps Power Tool gives you the ability to enable or disable apps installed on the computer and to uninstall app updates that may be causing storage or performance issues. You can also view the total number of apps on the computer and the total number of apps currently disabled.
	Configure Autorun	Configure Autorun provides the ability to set applications to automatically run after a reboot.
	Diagnostic Information	Diagnostic Information provides access to system statistics, notifications and version information about the computer.
	EZConfig	EZConfig supports advanced customization and configuration of the hand held computer. EZConfig includes a standard XML editor and configuration barcode scanner feature.
	WiFi Diagnostic	Use application to: <ul style="list-style-type: none"> <li>View Wi-Fi radio status information about a connected access point or a list of other available access points in range of the Wi-Fi radio.</li> <li>Use the Route utility to view packet destination gateway information across the subnets.</li> <li>Use the IPConfig utility to view IP parameters for the on-board network adapters.</li> <li>Use the Ping utility to verify communication links or to make sure a specific IP address is working.</li> </ul>
	Wireless Tether	Use to enable range tracking and customize out-of-range alerts for Bluetooth devices paired and tethered to your hand held computer.

## Applications You Can Download to the Mobile Computer

You can download Honeywell applications to extend the capabilities of the computer. You may need to purchase a license to run some applications. To learn more about the applications described in this section and other Honeywell software solutions, go to [sps.honeywell.com](http://sps.honeywell.com).

## About Honeywell Enterprise Browser

Honeywell Enterprise Browser is a locked-down enterprise Web client application designed for Honeywell computers. It provides a controlled Web application environment that helps enterprises increase productivity and reduce IT management expenses. You can configure Enterprise Browser for your specific application requirements and design custom web applications that run through the Enterprise Browser to provide your users with an easy-to-use yet controlled experience.

If Enterprise Browser is not included on your computer model, you can download a trial version for evaluation. After the evaluation period expires, you need to purchase a license. For more information about Enterprise Browser, visit [sps.honeywell.com](http://sps.honeywell.com).

## About Terminal Emulators

Honeywell offers several terminal emulator solutions that allow users to manage their mobile devices by providing reliable data transfer between the host mobile device and terminal. Terminal emulators can be used for remote management and configuration of devices, data collection and analysis, and session management.

Depending on the computer model, a terminal emulator may come preinstalled on the device. If a terminal emulator is not included on your model, you can download a trial version for evaluation. After the evaluation period expires, you need to purchase a license. For more information, visit [sps.honeywell.com](http://sps.honeywell.com).

## About Honeywell Launcher

Launcher is a configurable locked-down menu program designed for Honeywell computers that prevents end-users from accessing the start menu and other non-authorized applications. Use Launcher to provide a platform where your mobile computer users are limited to running only company-approved applications and prevent them from initiating unauthorized configuration changes. You can also use Honeywell Launcher together with Honeywell Enterprise Browser to create a single-purpose device configuration.

If Launcher is not included on your computer model, you can download a trial version of the software for evaluation. After the evaluation period expires, you need to purchase a license. For more information about Launcher, visit [sps.honeywell.com](http://sps.honeywell.com).



# Unlock Developer Options

Developer options only appear in the Settings app if you unlock the feature. If you are a developer working with the computer, you can easily unlock the additional settings to use for testing and debugging applications under development for the computer.

1. Swipe up from the bottom of the Home screen to access all apps.
2. Tap **Settings**  > **About phone**.
3. Tap **Build number** seven times. A message appears informing you that you are now a developer.
4. Open **Settings** > **System** and scroll to the bottom of the list.
5. Tap **Advanced**.
6. Tap **Developer options**.



# USE THE IMAGER

Use this chapter to understand how to scan barcodes, configure the scan settings, and capture images using the integrated image engine in the computer.

## About the Imager

The EDA57 mobile computer features the following Honeywell high-performance imager:

- S0703-SR Standard Range Imager

You can use the imager in the computer as a scanner or camera.

- Use the imager as a scanner to read 1D and 2D barcode symbologies, composite symbologies, and postal codes. It also supports omni-directional scanning for greater flexibility in real-world settings. By default, the scanner feature is enabled and uses the default scan profile. You can modify the **Default Profile** or create new profiles for custom applications from **Settings**  **Honeywell Settings** > **Scanning**.
- Use the imager as a camera to capture black and white images, such as signatures or pictures of damaged inventory. The imager camera feature requires the development of a custom application that uses the Honeywell Mobility SDK for Android. To download the Honeywell Mobility SDK for Android, see [Developer Information](#) on page 73.

**Note:** *Instead of using the internal imager, you can also use Bluetooth communications to connect the computer to an external scanner, such as the Granit™ 1990i and 1991i.*

## About the Scan Wedge Feature

The scan wedge feature sends scanned barcode data to an active application as Android keypad input. To scan a barcode as keyboard input, open an application that accepts text input and then scan a barcode. You can use applications that are

coded to use the scanner or applications that receive data through the scan wedge feature. If an application claims the scanner through the BarcodeReader API, the scan wedge feature is temporarily disabled.

You can find information on how to create custom applications for the computer in the *Software Development Kit (SDK)* available for download from the *Technical Support Downloads Portal* at [honeywell.com/PSSsoftware-downloads](https://honeywell.com/PSSsoftware-downloads). Once you create an account and enter the portal, navigate to **Software > Software and Tools > Developer Library > SDKs for Android**.

## Change the Scanner Settings

Changes you make to the Default profile apply to all applications with no profile assigned.

1. Swipe up from the bottom of the Home screen to access all apps.
2. Tap **Settings**  > **Honeywell Settings** > **Scanning**.
3. Tap **Internal Scanner** > **Default profile**.
4. Select from the following:
  - **Data Processing Settings**,
  - **Symbology Settings**,
  - **Decode Settings**,
  - **Imager Settings**,
  - **Trigger Settings**, or
  - **Notification Settings**.
5. Modify the settings to meet your application needs.

To learn more about the scanner settings, see [Default Scan Settings](#) on page 35.

## Change the Bluetooth Scanner Settings

When the Bluetooth scanner is paired, changes can be made to the Default profile for the scanner.

1. Swipe up from the bottom of the Home screen to access all apps.
2. Tap **Settings**  > **Honeywell Settings** > **Scanning**.
3. Tap **Bluetooth Scanner** > **Default Profile** > **Data Processing Settings**.
4. Modify the settings to meet your application needs.

To learn more about the scanner settings, see [Data Processing Settings](#) on page 35.

# Restore Default Scan Settings

You can easily discard all changes you made to the Default profile and restore the default values.

**Note:** When you choose the *Restore all defaults* option from a settings screen in a profile, all the settings in that profile return to their default values.

1. Open the **Default profile**.
2. Tap  in the upper right corner of any of the scan settings screens for the profile.
3. Tap **Restore all defaults**.

# Default Scan Settings

Use the following sections to understand the scan settings available for scanner profiles. To learn how to create a new profile, see [Add a Scan Setting Profile](#) on page 41.

# Data Processing Settings

Use the Data Processing Settings to specify how barcode data is processed by the computer.

## Data Processing Settings

Setting	Description	Default										
Wedge	Enable or Disable the scan wedge feature.	Enabled										
Wedge Method	Specify wedge method: Standard or Keyboard	Standard										
Charset	Select the character set to use when interpreting the barcode data into a string.	ISO-8859-1										
Prefix	Defines the string added before the decoded barcode data. Substitutions occur within the Prefix string values. <table border="1" data-bbox="630 1402 1252 1619"><thead><tr><th>Substring</th><th>Replacement Character Code</th></tr></thead><tbody><tr><td>\r</td><td>13</td></tr><tr><td>\n</td><td>10</td></tr><tr><td>\t</td><td>9</td></tr><tr><td>\\</td><td>'\'</td></tr></tbody></table>	Substring	Replacement Character Code	\r	13	\n	10	\t	9	\\	'\'	None
Substring	Replacement Character Code											
\r	13											
\n	10											
\t	9											
\\	'\'											

Setting	Description	Default										
Suffix	<p>Defines the string added after the decoded barcode data. Substitutions occur within the Suffix string values.</p> <table border="1"> <thead> <tr> <th>Substring</th> <th>Replacement Character Code</th> </tr> </thead> <tbody> <tr> <td>\r</td> <td>13</td> </tr> <tr> <td>\n</td> <td>10</td> </tr> <tr> <td>\t</td> <td>9</td> </tr> <tr> <td>\\</td> <td>'\'</td> </tr> </tbody> </table>	Substring	Replacement Character Code	\r	13	\n	10	\t	9	\\	'\'	None
Substring	Replacement Character Code											
\r	13											
\n	10											
\t	9											
\\	'\'											
Wedge as Keys	List of character values to wedge as keys, represented as a comma-separated list of decimal values.	9,10,13										
Data Editing Plugin	Specify a Total Freedom data editing plug-in and edit plug-in settings.	None										
Symbology Prefix	<p>Specify a symbology identifier prefix to the barcode data. Options include:</p> <ul style="list-style-type: none"> <li>None</li> <li>Honeywell</li> <li>AIM</li> </ul>	None										
Launch Browser	<p>Enable or disable URL barcode handling. If a barcode starts with http:// or https://, the browser opens using the barcode data as a URL.</p> <p>Corresponds to BarcodeReader property: PROPERTY_DATA_PROCESSOR_LAUNCH-BROWSER</p>	Enabled										
Scan to Intent	<p>Enable or disable special handling of scan-to-intent barcodes.</p> <p>Applies to barcodes in one of the following formats:  '/' ACTION  '/' ACTION '\$' extra-data</p> <p>Where: ACTION and extra-data are any string of characters.</p> <p>Launches an application listening for the intent.  Intent action:  "com.honeywell.scantointent.intent.action." + ACTION  Intent extra:  "com.honeywell.scantointent.intent.extra.DATA" contains the remainder of the barcode data after the first '\$' character.</p> <p>Corresponds to BarcodeReader property: PROPERTY_DATA_PROCESSOR_SCAN_TO_INTENT</p>	Enabled										
Launch EZConfig	<p>Enable or disable special handling of EZConfig barcodes.</p> <p>Applies to EZConfig barcodes that are encoded with the Aztec symbology and contain specific header data.</p> <p>Corresponds to BarcodeReader property: PROPERTY_DATA_PROCESSOR_LAUNCH_EZ_CONFIG</p>	Enabled										

Setting	Description	Default
Data Intent	Enables the reception and processing of barcode data without using an SDK or library.	Disabled

## Symbology Settings

Use the Symbology Settings to enable or disable barcode symbologies for the selected scan setting profile.

- Tap the check box next to a symbology name to enable (check mark) or disable (no check mark) decoding for that symbology.
- Tap the symbology name to view and modify additional configuration parameters for the symbology selected.

To view a list of default settings for supported symbologies, see [Barcode Symbologies](#) on page 84.

## Decode Settings

Adjust the Decode Settings when scanning barcodes that are densely packed or poor quality.

### Decode Settings

Setting	Description	Default
Center Decode	<p>When enabled, the imager scans and decodes a barcode only if part of the barcode is at the center of the aimer window. This is useful in situations where several barcodes may be very close together in the imager field-of-view.</p> <ul style="list-style-type: none"> <li>• Tap the check box to toggle the feature On or Off.</li> <li>• Select <b>Center Decode</b> to adjust the feature parameters.</li> </ul> <p>Honeywell recommends leaving the window size settings at 50 (default) to define the “center” area for the barcode.</p> <p>Configurable parameters:</p> <ul style="list-style-type: none"> <li>• Center Decode Timeout (ms)</li> <li>• Window top</li> <li>• Window bottom</li> <li>• Window left</li> <li>• Window Right</li> </ul>	Disabled
Decode Security	Use this setting to control the reading tolerance of the decoder. Lower settings are more lenient when reading low quality barcodes while higher values are more strict.	2
Decoder timeout	Set the amount of time in milliseconds that the scanner will timeout if a readable barcode is not found.	150

Setting	Description	Default
Decode Filter	<p>Use these settings to modify or reject data strings.</p> <ul style="list-style-type: none"> <li>• Decode Filter Script The Decode Filter Script is used to configure a filter for decode results during scanning. For example, a filter could be used to reject barcodes that don't begin with certain characters, remove leading characters (like "00") from the beginning of a barcode, or only scan barcodes that begin with certain characters.</li> <li>• Decode filter timeout (ms) The decode filter timeout option can be used to disable the logic inside the filter script after a given amount of time.</li> <li>• Debug level Set the filter information level. The default level is 0, no information. Higher levels emit more information. Level 4 emits the most information.</li> </ul>	none
Poor Quality 1D Reading	Enable this setting when scanning damaged or badly printed 1-D barcodes to improve barcode read success.	Disabled
Video mode	<p>Use this setting to specify whether normal or inverse decoding for linear symbologies is enabled during the execution of Decode. By default normal video is enabled.</p> <p>Options include:</p> <ul style="list-style-type: none"> <li>• Normal</li> <li>• Inverse</li> <li>• Normal and Inverse</li> </ul>	Normal
DPM mode	<p>Use this setting when scanning Direct Part Marking (DPM) barcodes that are etched or imprinted directly into the surfaces of materials including metal and plastic.</p> <p>Options include:</p> <ul style="list-style-type: none"> <li>• No DPM optimization</li> <li>• Dotpeen DPM decoding</li> <li>• Reflective DPM decoding</li> </ul>	No optimization



Setting	Description	Default
Region of Interest	<p>Set the ROI for decoding. Options include:</p> <ul style="list-style-type: none"> <li>• <b>Disable</b> ROI is disabled and the entire original image is sent to the decoder.</li> <li>• <b>Standard</b> Use the aimer position to weight activity. Activity calculated on the row and the column in the middle of each cell. The ROI window may not include the aimer.</li> <li>• <b>Standard, aimer centered</b> Activity calculated on the row and the column in the middle of each cell. The ROI window will always include the aimer.</li> <li>• <b>DPM, aimer centered</b> Activity calculated on 4 rows and 2 columns in each cell. The ROI window will always include the aimer.</li> <li>• <b>Kiosk/presentation application</b> Ignore aimer position, no weight activity. Activity calculated on the row and the column in the middle of each cell. The ROI window may not include the aimer.</li> <li>• <b>Learning Engine</b> When selected, the computer will receive continuous updates to improve the decoder software based on your specific environment. The Staging Hub Agent must also be enabled.</li> </ul>	Disabled
Multicode Scan	<p>When you enable Multicode Scan, each barcode is checked to see whether it satisfies the defined multicode rules before the results are transmitted. Options include:</p> <ul style="list-style-type: none"> <li>• Enable or disable multicode scanning.</li> <li>• Set the number of barcodes.</li> <li>• Specify a separator to be used between barcodes.</li> <li>• Define up to 10 barcodes to be included in the multicode.</li> <li>• Set a timeout in milliseconds. If set with a non-zero value, the timeout starts after the scan button is pressed. Once the timeout occurs, scanning will return to standard (single) barcode mode.</li> <li>• Enable or disable the transmission of an incomplete multicode. When enabled, the incomplete multicode is transmitted when the incomplete transmission timeout expires.</li> <li>• Set a timeout in milliseconds to use when incomplete transmission is enabled. If set with a non-zero value, the timeout starts after the scan button is pressed. Once the timeout occurs, the results that were collected before the timeout happened will be transmitted if they satisfy the defined multicode rules.</li> </ul>	Disabled

Setting	Description	Default
Preferred Symbology Settings	<p>Use this setting to establish which barcode has priority if more than one barcode appears on the same label.</p> <ul style="list-style-type: none"> <li>Tap the check box to toggle the feature On or Off.</li> <li>Select <b>Preferred Symbology Settings</b> to adjust the feature parameters.</li> </ul> <p>Options include:</p> <ul style="list-style-type: none"> <li><b>Preferred Timeout (ms)</b> The length of time the scanner will ignore a low priority barcode while it searches for a high priority barcode. If a high priority symbology is located during this period, then that data is read immediately. If the time-out period expires before a high priority symbology is read, the scanner will read any barcode in its view. The default is 500ms.</li> <li><b>Symbology</b> Set the priority level (High or Low) for symbology codes. This is used when you want to specify one symbology as a higher priority over other symbologies in situations where both barcode symbologies appear on the same label, but the lower priority symbology cannot be disabled. If a code is set as a High Priority, the decode of that symbology is accepted immediately. If a code is set as a Low Priority, the decode is buffered to see if a decode of a preferred High Priority symbology can be found within a given timeout period.</li> </ul>	Disabled

## Imager Settings

You should not need to modify the Imager Settings. The **Override Recommended Values** setting is disabled by default. The recommended Imager Settings are designed to work in a wide range of environments and should only be modified if you have an advanced understanding of imagers.

## Trigger Settings

Use the Trigger Settings to configure how the scan buttons work.

### Trigger Settings

Setting	Description	Default
Enable Scan Trigger	Enable or Disable activating the imager by pressing the side scan buttons or the virtual Scan button in the Scan Demo app.	Enabled
Scan delay	Set the minimum amount of time in seconds before the scanner can read another barcode.	0
Decode Timeout	Set the number of seconds before the scanner automatically turns Off if the scan button is pressed and nothing has successfully decoded.	20

Setting	Description	Default
Trigger Scan Mode	Set read behavior on scan button press. Options available: <ul style="list-style-type: none"> <li>One Shot</li> <li>Continuous</li> <li>Read on release</li> <li>Read on second trigger press</li> </ul>	One Shot
Same symbol timeout	Set the minimum buffer time in seconds before the scanner reads the same barcode. This can be adjusted to prevent inadvertent scans of the same barcode if the code is left in the scan field longer than the Decode Timeout limit. The default same symbol timeout is 1000 seconds.	Disabled

## Notification Settings



Use the Notification Settings to configure how your computer responds when you scan a barcode.

### Notification Settings

Setting	Description	Default
Good Read Notification	Enables or disables a good read notification. The notification consists of a green blink of the Good Read LED, a short beep, and an optional short vibration.	Enabled
Bad Read Notification	Enables or disables notification of a failed scan. The notification consists of a red blink of the Good Read LED, an error beep, and an optional short vibration.	Disabled
Vibrate On Notification	Enables or disables whether the computer vibrates when there is a good or bad read.	Disabled

## Add a Scan Setting Profile

To create a scan setting profile for a custom app on the computer:

1. Swipe up from the bottom of the Home screen to access all apps.
2. Tap **Settings**  > **Honeywell Settings** > **Scanning** > **Internal Scanner**.
3. Tap  in the upper right corner of the app screen.
4. Take one of the following actions:
  - Tap the **Profile name** field, and then add a new name.

OR

  - Tap the **select an application** option, and then choose an app from the list.

The new profile appears on the Internal Scanner profile list. You can now select and modify the scan settings for the new profile.

## Delete a Scan Setting Profile

1. Swipe up from the bottom of the Home screen to access all apps.
2. Tap **Settings**  > **Honeywell Settings** > **Scanning** > **Internal Scanner**.
3. Tap and hold the profile you want to delete, select **Delete** and then click **OK**.

## About ScanHandle Settings

1. Swipe up from the bottom of the Home screen to access all apps.
2. Tap **Settings**  > **Honeywell Settings** > **ScanHandle Settings**.
3. Tap **Enable ScanHandle** to turn the feature On.

A preview of the button appears at the bottom of the screen. Attach the scan handle to the mobile computer for easier grip and trigger action when scanning labels.

## About the Optional Digital Scan Button

By default, the imager is enabled for scanning with the left and right Scan buttons configured to trigger the imager. If your application environment requires use of an on-screen Scan button, enable the Digital Scan Button feature in the Settings app. Once enabled, you can then modify the appearance of the on-screen Scan button and select the apps the button appears in.

## Enable and Configure the Digital Scan Button

1. Swipe up from the bottom of the Home screen to access all apps.
2. Tap **Settings**  > **Honeywell Settings** > **Digital Scan Button**.
3. Tap **Enable Digital Scan Button** to turn the feature On. A preview of the button appears at the bottom of the screen.
4. Configure the button appearance. As you adjust the settings, the preview of the button updates.
  - Tap **Select Button Size**, and then choose Small, Medium, or Large.
  - Tap **Select Button Color**, and then choose from seven color options. Default color is black. Tap a dot to select the color, and then select **OK** to confirm.
  - Use the slider under **Transparency Level** to adjust how transparent the button appears on the application screen.
5. Drag the preview of the Scan button to the location where you want it to appear on the screen. Once you have positioned the button, tap the **Set Button Location** toggle button to lock it into position.

6. Tap **Choose Application**.
7. Check the box next to all the applications where you want the digital scan button to be available.
8. Select **OK**.
9. Tap the **Back** arrow to return to the Settings screen.

The digital scan button appears on the screen when you open any of the apps you selected during the button setup. Tap and hold the button to activate the imager and scan a barcode.

## Scan Barcodes

By default, the integrated imager is enabled for scanning. It supports omni-directional (360°) barcode scanning, and an aiming beam is provided to help assist with targeting barcodes.

Before you start scanning barcodes, go into **Settings**  > **Honeywell Settings** > **Scanning** > **Internal Scanner** and modify the scan profile to enable only the barcode symbologies that you need. By reducing the active symbology list, you can increase scan speed.

1. Point the imager window at the barcode. For optimum performance, avoid reflections by scanning the barcode at a slight angle.
2. Press and hold any **Scan** button.
3. Center the aiming beam over the barcode. Make sure the entire barcode is inside of the illumination frame.
4. Release the **Scan** button when the computer beeps and the Good Read LED briefly turns on. The barcode information is entered into the application in use.

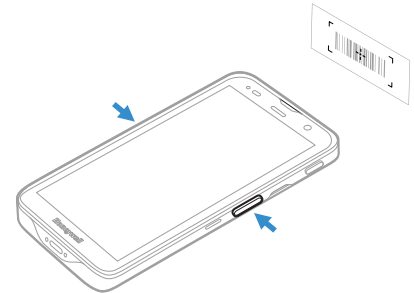

**Note:** *Not all barcode symbologies are enabled by default. If a barcode does not scan, the correct symbology may not be enabled.*

## About Scanning Configuration Barcodes

After completing the out-of-box set up process, Provisioning mode is automatically turned off. Scanning a barcode to install applications, certificates, configuration files, and licenses on the computer is restricted unless you enable Provisioning mode in the Settings app.

To learn more [About Provisioning Mode](#), see page 73.

# Use the Scan Demo App

Use the Scan Demo app to read barcodes or to test your symbology decode settings.

1. Swipe up from the bottom of the Home screen to access all apps.
2. Tap the **Demos** app.
3. Swipe left or right on the screen until **Scan Demo** appears under the turntable. Tap the center of the box image to open the app.
4. Point the imager window at the barcode.
5. Press and hold either side **Scan** button or tap **SCAN** on the computer screen.
6. Center the aiming beam over the barcode. Make sure the entire barcode is inside of the illumination frame.
7. Release the **Scan** button when the computer beeps, and the Good Read LED briefly turns on. Barcode information appears on the screen.

**Note:** *In the Scan Demo app, not all barcode symbologies are enabled by default. If a barcode does not scan, the correct symbology may not be enabled.*

## Change the Scan Demo Symbology Settings

1. In the Scan Demo app, tap **⋮** in the upper right corner of the screen.
2. Select **Symbology Settings**.
3. Modify the symbology parameters.
  - Tap the check box next to a symbology name to enable (check mark) or disable (no check mark) decoding for that symbology.
  - Tap the symbology name to view and modify additional configuration parameters for the symbology selected.
4. Tap the **Back** arrow to return to the Scan Demo app.

# USE THE PHONE

You can use the phone feature to make and receive phone calls as well as transmit data through wireless wide-area networks (WWANs).

**Note:** *Phone features are only supported on EDA57-1 models.*

## About the Phone

Phone features on the computer include a speaker and two microphones for noise cancellation. You can also use a hands-free kit or headset that supports Bluetooth® wireless technology.

On WWAN models, the phone feature is enabled by default and supports most cellular radio access technologies for voice and data connections around the globe.

After you turn on the phone and activate service with your wireless carrier, you can customize the phone features and network settings in the Network & internet section of the Settings app.

**Note:** *WWAN radios support Network Information and Time Zone (NITZ) messages to automatically set the system time.*

## Activate the Phone

Use a nano-SIM card to activate the phone and connect to a mobile network. Contact your mobile service provider to obtain a nano-SIM card or for additional details on phone network activation.

## Dual SIM Dual Standby Mode

The nano-SIM can be provisioned with either the same or different mobile carriers. When both SIMs are provisioned, the EDA57-1 operates in Dual SIM Dual Standby (DSDS) mode. In this mode, both SIMs can connect to the selected mobile network. For example, you can have two phone lines on your mobile computer where one is

your business number and one is your personal number. You can also choose which SIM to use for specific actions, such as calls or messaging. These actions are defined in **Settings > Network & internet > Mobile network**.

## Provision nano-SIM Card

1. Press and hold the **Power** button until the options menu appears.
2. Tap **Power Off**.
3. Remove the battery from the computer. Refer to [page 6](#).
4. Slide the card holder tray out of the slot.

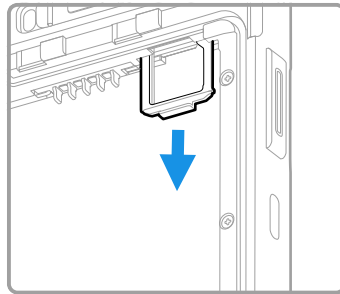

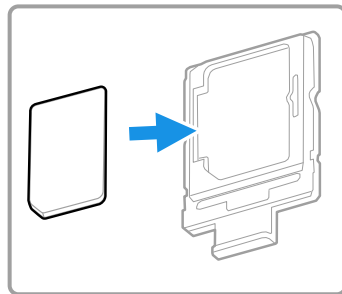

5. Place the nano-SIM card into the tray with contacts facing down.







6. Slide the card holder tray back into the card holder slot.
7. Install the battery. Refer to [page 8](#).
8. Press the **Power** button to restart the mobile computer.
9. Follow the mobile provider's instructions to complete the setup and activate the phone.

## Make a Phone Call

Once the phone is activated, you can make a phone call.



1. Tap  in the favorites tray to open the phone app.
2. Use one of the methods below to enter the telephone number you want to call.
  - Tap  and use the on-screen dialer.



- Select a person on your saved contact list .
  - Select a favorite on your speed dial list .
  - Select a number from the recent calls list .
3. Tap call .
  4. To end the call, tap .

## Answer the Phone

When you receive a phone call, the Incoming Call screen opens. If the caller's telephone number is available, it appears on the screen. Depending on your calling plan, you may also see a Caller ID information. All incoming calls are recorded in the Call log. If you miss a call, you receive a notification.

1. On the Incoming Call screen, tap and hold the white call icon.
2. Three icons appear:
  - To answer the call, drag the icon to .
  - To send the caller directly to voice mail, drag the icon to .
  - To send a text message back to the caller instead of answering, drag the icon to .

## Switch Apps During a Phone Call

You can multitask while a phone call is in progress. For example, you can use the Calendar app to check your schedule during a call.

**Note:** *Depending on your WWAN connection and carrier, apps that need a data connection may be unable to access online data while the phone call is in progress. If simultaneous phone calls and data connections are not possible due to provider limitations, voice calls receive priority. Check with your provider for more information.*



1. During a phone call the screen goes dark. Take the phone away from your ear to wake the screen. Tap the **Home** button.
2. Select another app (e.g., Calendar, Contacts). The phone icon appears in the status bar at the top of the screen while the call is connected.
3. To return to the call screen, swipe down from the top of the screen and select ongoing call notification or select **Hang up** if you want to end the call.

# Make an Emergency Phone Call

You can use the phone to make an emergency phone call even if the SIM card is missing from your phone. The phone shows no service but the call still goes through if you dial certain emergency numbers (e.g., 112, 911, 000, 08, 118, 119, and 999).

# Configure Phone Settings

You can customize settings for the phone, including the ringtone, voicemail options, keypad tones, Internet call settings, and other options.

1. Open the phone app .
2. Tap  next to the microphone icon at the top of the screen.
3. Select **Settings**. The Call settings menu appears.
4. Change phone settings as necessary.

**Note:** Available settings vary depending on your cellular carrier and phone plan.

Use this chapter to learn how to take pictures and record videos with the color camera(s).

## About the Color Camera

The EDA57 mobile computer comes equipped with two cameras, a 16-megapixel color camera on the back of the computer and a 8-megapixel camera located on the front.

All models include 4K video support with image stabilization and advanced software features for enhanced exposure control when taking pictures and videos.



Use the **Photos** app  to view photos and videos stored on the mobile computer. By default the photos and videos captured with the Camera app are saved on the computer under Internal shared storage\DCIM\Camera.

## How to Zoom

The camera zoom is controlled using a pinching motion on the touch screen. Place two fingers on the screen at the same time, and then:

- spread your fingers apart to zoom in (enlarge an object), or
- pinch them together to zoom out.







## Take a Photo

1. Tap the **Camera** icon  in the favorites tray on the Home screen.
2. Select  to switch between the front and rear camera. The front camera does not include a Flash feature.

3. Using the screen as a viewfinder, move the computer until you see the image you want to capture.
4. The camera automatically adjusts the focus but you can tap the screen to modify the focal point. By default, the camera senses the lighting in the environment and turns the flash on, if needed.
5. Tap  or the Volume button to take a photo.
  - To view the picture, tap the preview near the bottom of the screen.
  - To return to the Camera app, tap the **Back** navigation button.

## Record a Video

This section explains how to record video with the camera in the computer.

1. Tap the **Camera** icon  in the favorites tray.
2. Tap  to start recording video.
  - To zoom in or out, pinch or spread your fingers apart.
  - To toggle sound recording On or Off, tap the microphone icon at the top of the screen.
  - To pause recording, select . To resume recording, tap .
  - To capture a still picture during recording, tap the **Camera** icon .
  - To add light while recording, tap the flash icon. Flash is only available with the rear camera on the back of the computer.
3. When you are done recording, tap .

# Change Camera Settings

You can change the camera settings for best results when taking pictures. The camera settings are adjustable from within the Camera app.

1. Open the **Camera** app .
2. At the top of the screen, select any of the following to adjust the settings. The options vary depending on camera mode selected.

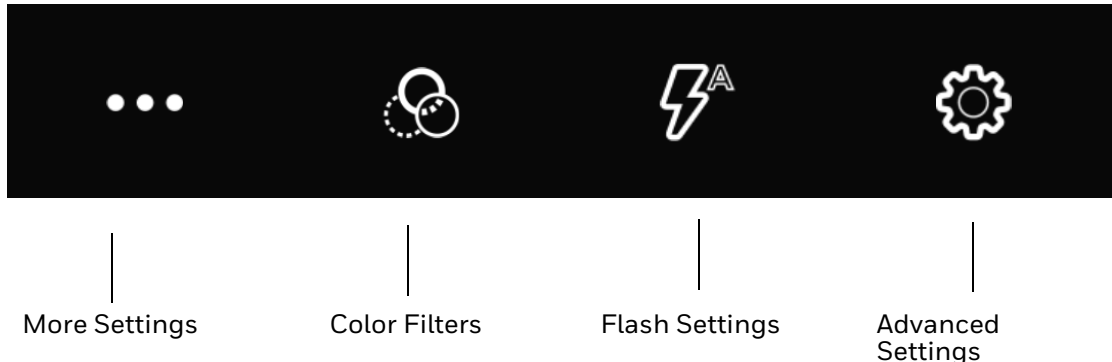

- **More Settings**  
Select to access HDR, Automatic and Advanced settings.

## **HDR**

Tap to quickly toggle HDR mode On or Off. When enabled, the computer automatically captures multiple photos and combines them into one photo, creating the best quality image possible.

## **Automatic**

Select Automatic to have the camera automatically adjust the settings and focus for you.

- **Advanced Settings**

Select the gear  to access settings that allow you to modify the camera setting defaults and to configure how the camera app functions (i.e., General, Still camera, Video camera, System).

# Use the Camera as a Flashlight

To use the rear camera as a flashlight.

1. Open Quick Settings (see page [25](#)).
2. Tap the Flashlight icon to toggle the flashlight On or Off.

**Note:** *The flashlight feature only works if the camera app is closed.*



# CONFIGURE THE COMPUTER

Use this chapter to learn about the available methods for configuring your mobile computer. You can also use this chapter to learn how to configure network communications and wireless security.

## How to Configure the Computer

You can configure many parameters on the computer such as the barcode symbologies it decodes or the network settings. The values you set for these parameters determine how the computer operates. You configure the computer using the Settings app.

### Start the Settings App

The Settings app is available from the all apps menu and the notification panel.

- Swipe up from the bottom of the Home screen, and then tap **Settings** .

OR

- Swipe down twice from the top of the Home screen, and then select .

### About the Structure of the Settings App

Use this section to learn about the structure of the Settings app so you can find parameters quickly. A search field appears at the top of the screen when you open the Settings app to help you locate settings quickly.

**Note:** *The Settings app varies by computer model and OS version. Your computer may not include all the features outlined in this section.*

## Network & internet

In the Settings app, select **Network & internet** to access the following settings.

Setting	Description
Wi-Fi	<ul style="list-style-type: none"> <li>• Turn Wi-Fi radio On or Off.</li> <li>• Lists available Wi-Fi networks in range and the connection status when the radio is turned On.</li> <li>• Add a network Wi-Fi connection and view saved networks.</li> <li>• Tap <b>Wi-Fi preferences</b> to access advanced Wi-Fi options, view MAC and IP address information, access Honeywell Wi-Fi settings (see <a href="#">page 66</a>), and import and export Wi-Fi configurations.</li> </ul>
Mobile network (WWAN models)	<p>Modify mobile network settings, including enabling data access and roaming over mobile networks, selecting access points and network operators, or selecting only 2G networks (to save battery life).</p> <ul style="list-style-type: none"> <li>• Turn Mobile data On or Off.</li> <li>• Turn Roaming On or Off.</li> <li>• View Data use information.</li> <li>• Access advanced options, including: <ul style="list-style-type: none"> <li>• 5G Mode On/Off setting</li> <li>• Preferred network settings</li> <li>• CDMA roaming settings and subscription settings (i.e, RUIM/SIM, NV)</li> <li>• Access point name and selection</li> <li>• Network selection settings</li> </ul> </li> </ul>
Airplane mode	Turn Airplane mode On or Off.
Ethernet	<ul style="list-style-type: none"> <li>• Turn Ethernet connection On and Off.</li> <li>• View last Ethernet connection information.</li> </ul>
Mobile plan	Provides information on your cell phone plan.
Hotspot & Tethering	<ul style="list-style-type: none"> <li>• Enable or disable Bluetooth or Ethernet tethering for sharing mobile data connections.</li> <li>• Enable or Disable using the computer as a portable Wi-Fi hotspot.</li> <li>• Configure Wi-Fi hotspot.</li> </ul>
Advanced	
Data Saver	Turn the Data saver feature On or Off. Specify which apps can use unrestricted data.
VPN	Set the password parameters for a virtual private network (VPN) connection.
Private DNS	Select Private DNS Mode.



## Connected devices

In the Settings app, select **Connected devices** to view current, connected devices and to access the following settings.

Setting	Description
Pair new device	<ul style="list-style-type: none"> <li>• Connect to a Bluetooth Device.</li> <li>• Lists Bluetooth enabled devices in range.</li> <li>• View and rename the computer.</li> <li>• View the computer Bluetooth address.</li> </ul>
USB	<p>Select the type of communication:</p> <ul style="list-style-type: none"> <li>• File Transfer</li> <li>• USB tethering</li> <li>• PTP</li> <li>• No data transfer</li> </ul> <p><b>Note:</b> This setting only appears when the unit is connected via USB.</p>
Previously connected devices	<p>View previously connected devices.</p> <p><b>Note:</b> This setting only appears once the computer has been paired with another device.</p>
Connection Preferences	
Bluetooth	<ul style="list-style-type: none"> <li>• Turn the Bluetooth radio On or Off.</li> <li>• Lists Bluetooth enabled devices in range when the radio is turned On.</li> <li>• Connect to a Bluetooth Device.</li> <li>• View and rename the computer.</li> <li>• View the computer Bluetooth address.</li> </ul>
NFC	<p>Turn Near Field Communication (NFC) On or Off. When the NFC radio is enabled, data exchanges are allowed when the computer touches another NFC enabled device.</p>
Cast	<p>Set up a Cast connection. Cast (project) audio and screen content to a secondary device such as a television.</p>
Printing	<p>Set up a printer connection with the computer. Connection options include cloud print services, Wi-Fi printing via a router or printing via NFC.</p>
Files received via Bluetooth	<p>View statistics and received files.</p>
Chromebook	<p>Set up connection from the mobile computer to a Chromebook.</p>
Nearby Share	<p>Set up file sharing with nearby devices. The device location setting needs to be turned on for Bluetooth and Wi-Fi radios to detect nearby devices.</p>
Android Auto	<p>Use apps on your phone screen or car display. To learn more, go to Android Auto Help at <a href="https://support.google.com">https://support.google.com</a>.</p>

## Apps

In the Settings app, select **Apps** to access the following settings.

Setting	Description
Recently opened apps	View a list of recently opened apps or select "See all . ." to view a list of installed apps on the computer and system services running.
General	
Default apps	View and manage default app use.
Screen time	<ul style="list-style-type: none"><li>Shows Screen time, Notifications received, Times opened.</li><li>Allows to set app timer.</li></ul>
Unused apps	View and manage apps that are unused for over three months.
Special app access	Manage apps with special unrestricted access.

## Notifications

In the Settings app, select **Notifications** to access the following settings.

Setting	Description
Manage	
App Settings	Manage notifications from apps.
Notification history	View recent and snoozed notifications.
Conversation	
Conversations	View conversations marked as a priority.
Bubbles	Allow conversations to appear as floating icons on top of other apps.
Privacy	
Device & app notifications	Control which apps and devices can read notifications.
Notifications on lock screen	Manage how notifications appear on the lock screen.
Sensitive notifications	Turn On to show sensitive content when locked.
General	
Do Not Disturb	Turn On to prevent notifications from appearing. Manage which notifications can appear when Do Not Disturb is On.
Wireless emergency alerts	Manage emergency alert notifications.
Hide silent notifications in status bar	Turn On to prevent silent notifications from appearing in the status bar. Silent notifications are notifications that do not use a visual or audible alert.
Allow notification snoozing	Turn On to enable the ability to snooze a notification by tapping the alarm clock icon at the bottom of a notification.
Notification dot on app icon	Turn On to display a notification dot on an app icon when the app generates a notification.

Setting	Description
Blink light	Turn On to enable the notification LED to blink for notifications.
Enhanced notifications	Turn On to organize notifications and enable notifications to provide suggested actions and replies.

## Battery

In the Settings app, select **Battery** to view battery status, use statistics, and adjust features that conserve battery charge.

**Note:** Some settings in previous OS versions can be found in Display.

Setting	Description
Battery	View current battery charge or charging status.
Battery saver	Turn the Battery saver feature On or Off manually.  Set a schedule, based on the battery charge percentage (%) remaining that automatically activates the Battery saver feature. Use the slider to set the battery percentage level. Slider adjusts from 5% to 7% and is only available once schedule is selected.  When charging, set the battery saver feature to turn Off when the battery reaches 90%. Default setting.
Battery Manager	Turn the Battery Manager On or Off. Battery manager detects when apps drain the battery.
Battery percentage	Set to show or do not show battery percentage in status bar.
Last full charge	View time since the battery was fully charged.
Screen usage since last full charge	View amount of time when the screen was used since the battery was fully charged.

## Display

In the Settings app, select **Display** to access the following settings.

Setting	Description
Brightness level	Set the Brightness level manually if Adaptive brightness feature is turned Off.
Dark theme	Enable dark mode to switch app backgrounds to a black color.
Night light	Activate the Night light feature to adjust the screen tint to a light amber for easier viewing and reading in dim light or for the hours you use the device before going to sleep. Set the feature to stay on or define a schedule to turn the feature On or Off. You can manually adjust the intensity of the amber hue once the feature is activated.
Adaptive brightness	Set how the screen in sleep mode responds when new notifications are received (e.g., wake or do not wake).
Wallpaper	Set the wallpaper.
Advanced	
Screen timeout	Set the inactivity time limit before the unit automatically turns Off the screen to save battery power (seconds or minutes).

Setting	Description
Auto-rotate screen	Set the screen to switch from portrait to landscape when the unit is rotated. When Off, the screen does not automatically rotate.
Colors	Adjust the screen color settings (e.g, Natural, Boosted, Adaptive).
Font size	Set the default on-screen text size.
Display size	Set the default size of items on your screen.
Screen saver	Set the default screen saver as well as when to display it. Tap <b>Settings</b> to select screen saver style or to turn Night mode On.
Lock screen	Select what to show on the lock screen and when to display new notifications.

## Sound

In the Settings app, select **Sound** to modify the audio and sound settings. To learn more, see [Audio Settings](#) on page 16.

## Storage

In the Settings app, select **Storage** to view statistics on available and used storage space on the device and on any portable storage cards installed.

## Privacy

In the Settings app, select **Privacy** to define privacy settings for the device.

Setting	Description
Permission manager	Define which apps have access to features on the device, such as the camera or microphone.
Show passwords	Briefly displays the characters in a password as you type before hiding them.
Notifications on lock screen	Select whether or not to show all notification content on the lock screen.
Autofill service from Google	Automatically fill fields using saved data from your Google account.
Advanced	
Google location history	Enable or disable location history and manage or delete activity. A Google account must be associated with the device to use this feature.
Activity controls	Choose what type of activities are saved in your Google account. A Google account must be associated with the device to use this feature.
Ads	Opt in or out of ad personalization features. When this is On, ads are personalized with the activity and information from your Google Account.
Usage & diagnostics	Automatically send diagnostic, device, and app usage data to Google. By default, this setting is turned Off.

## Location

In the Settings app, select **Location** to define which apps have access to the device's location.

Setting	Description
Use Location	Turn location services (Google and GPS satellite data) On or Off. Set location mode accuracy and view location request history.

Setting	Description
App access to location	View and manage app-level location service permissions.
Wi-Fi and Bluetooth scanning	Turn Wi-Fi and/or Bluetooth scanning On or Off. When enabled, system apps and services are allowed to detect Wi-Fi networks or Bluetooth devices at any time to improve location services.
Advanced	
Emergency Location Service	Allows the device to automatically send its location to emergency locations.
Google Location Accuracy	Improves location accuracy by using Wi-Fi, mobile networks, and sensors to help estimate the device location.
Google Location History	Allows the device to report Location History to Google. A Google account must be associated with the device to use this feature.
Google Location Sharing	Allows the device to share its location with anyone in the contacts list.

## Safety & emergency

In the Settings app, select **Safety & emergency** to manage options for sending and receiving information in an emergency.

Setting	Description
Emergency information	Enter medical and contact information to aid first responders in an emergency.
Emergency SOS	When turned On, you can press the <b>Power</b> button five times to call for help or sound an alarm.
Emergency Location Service	Allows the device to automatically send its location to emergency locations.
Wireless emergency alerts	Manage emergency alert notifications.

## Security

In the Settings app, select **Security** to view latest Security scan results, security updates, and phone encryption status. Access additional settings related to device security.

Setting	Description
Google Play Protect	Manually initiate a scan of the apps on the device to check for problems.
Security update	Displays the last date security was updated on the device.
Find My Device	Allows users to locate, ring, or wipe a device remotely.
Screen Lock	Activate and configure a screen lock (i.e., None, Swipe, Pattern, Pin, Password).
Smart Lock	Define safe conditions or locations where your phone will stay unlocked (e.g. On-body, Trusted places, Trusted devices, Voice Match).
Device admin apps	Manage administrator privileges.

Setting	Description
Encryption & credentials	View encryption status and manage trusted credentials (e.g., view, install, clear, and edit).
Trust agents	View and enable/disable trusted agent apps such as Smart Lock by Google on the device. Trusted agents bypass security based on set parameters.
App pinning	Enable or disable the screen pinning feature. When enabled, you can pin the device screen to a recently used app where it stays until you unpin the app via the security method chosen.

## Passwords & accounts

In the Settings app, select **Passwords & accounts** to access the following settings.

**Note:** *Some settings in previous OS versions can be found in System.*

Setting	Description
Add account	Select to add and manage Corporate or Email account on the computer.
Automatically sync app data	Turn auto-sync On or Off for accounts. Turning the feature On allows apps to refresh data automatically.

## Accessibility

In the Settings app, select **Accessibility** to access screen readers, display settings, interaction controls, and audio & on-screen text features to improve accessibility levels.

Setting	Description
Screen Readers	
Select to Speak	When turned On, you can tap specific items on the screen to hear them read aloud.
TalkBack	When turned On, the feature provides spoken feedback so you can use the computer without always looking at the screen. TalkBack describes your actions and tells you about alerts and notifications
Text-to-speech output	Select and configure the preferred TTS, set language, speech rate and pitch of synthesized voice.
Display	Configure display features that may aid visual accessibility levels. <ul style="list-style-type: none"> <li>• Adjust Font size</li> <li>• Adjust Display size</li> <li>• Turn Dark theme On/Off</li> <li>• Turn the Magnification feature On/Off</li> <li>• Set Color correction</li> <li>• Turn Color inversion On/Off</li> <li>• Turn Large mouse pointer On/Off</li> <li>• Turn Remove Animations On/Off</li> </ul>

Setting	Description
Interaction controls	<p>Set interaction controls that may aid physical accessibility levels.</p> <ul style="list-style-type: none"> <li>• Accessibility Menu provides large on-screen menus.</li> <li>• Configure Switch Access. You can use a switch or keyboard to control your device.</li> <li>• Set the Dwell timing (click after pointer stops moving) delay.</li> <li>• Turn the Power button ends call feature On/Off.</li> <li>• Turn Auto-rotate screen On/Off.</li> <li>• Adjust the Touch &amp; hold delay.</li> <li>• Time to take action (Accessibility timeout).</li> <li>• Vibration &amp; haptic strength.</li> <li>• Set System navigation (e.g., Gesture navigation or 3-button navigation).</li> </ul>
Audio & on-screen text	<ul style="list-style-type: none"> <li>• Turn Mono audio On/Off.</li> <li>• Set Audio balance if using headphones or hearing aids.</li> <li>• Turn Captions On/Off.</li> </ul>
Experimental	<ul style="list-style-type: none"> <li>• Turn High contrast text On/Off.</li> <li>• Turn Shortcut from lock screen On/Off.</li> </ul>

## Honeywell Settings

In the Settings app, select **Honeywell Settings** to access the following settings.

Setting	Description
Battery LED	Configures the battery LED behavior. To learn more, see <a href="#">Change the Battery Status LED Behavior</a> on page 11.
Battery Optimizer	<p>View battery status and app usage information.</p> <p>Tap <b>Optimize Battery</b> to create and enable or disable a battery optimization profile that implements a group of settings to conserve power.</p> <p>Options include:</p> <ul style="list-style-type: none"> <li>• None When selected, no battery optimization profile is active.</li> <li>• Energy Saver This pre-defined profile implements UI settings that optimize battery conservation.</li> <li>• Cold Storage This pre-defined profile implements UI settings that optimize battery savings in cold storage environments.</li> <li>• Custom Profile Tap to create a custom battery profile that balances your application needs with energy saving settings. You can turn location services On or Off, configure sound and vibration options, modify brightness and timeout display options, turn UI transition animations On or Off and background services On or Off.</li> </ul>
Digital Scan Button	Enable and configure the optional digital scan button. To learn more, see <a href="#">About the Optional Digital Scan Button</a> on page 42.

Setting	Description
Glove Mode	Enable or disable Glove Mode.
HXLogger	<p>The HXLogger is an advanced diagnostic log service that provides a basic log service, plug-ins for modified log services, and a log manager.</p> <ul style="list-style-type: none"> <li>• Tap <b>HXLogger</b> to turn the basic log service On/Off. When enabled the service records app and system diagnostic troubleshooting information into four basic log files: main log file, radio log, event log, and kernel dynamic log.</li> <li>• Tap <b>Kernel dynamic log</b> to toggle feature On or Off and to set the Input file name and Input function name. This log is typically used by advanced software application developers.</li> <li>• Tap <b>Plugin</b> to view and enable additional log services and custom plug-ins.</li> <li>• Tap <b>Manager</b>, to change the default log path, delete logs, or upload logs for technical support troubleshooting.</li> </ul> <p>Select the more icon  to Select the max bootset count or to manually Sync Log.</p>
Key WakeUp	Set the buttons you want to use to wake the computer from sleep mode. Options include: Left Scan, Right Scan, Volume Up, Volume Down. By default, the Left and Right Scan buttons are enabled for wake up.
Keyremap	Change (remap) a button or key function. To learn more, see <a href="#">Remap a Button</a> on page 23.
Provisioning Mode	Enable or disable unrestricted installation of applications, certificates, configuration files, and licenses. Provisioning mode is turned Off by default. To learn more <a href="#">About Provisioning Mode</a> , see page 73.
ScanHandle Settings	Enable or Disable Scan handle. To learn more, see <a href="#">About ScanHandle Settings</a> on page 42.
Scanning	Configure the computer imager. To learn more, see <a href="#">Change the Scanner Settings</a> on page 34.
Smart sensor	Configures the integrated motion detection sensors for advanced power management. Options include: Keep awake on motion, Wake on motion, Face down suspend.
Staging Hub Agent	Use this agent and settings to connect the computer to the Honeywell Staging Hub Foundation software platform; a centralized software platform IT integrators and administrators can use as a solution for managing, monitoring and deploying Honeywell devices in a connected workspace environment.
Web Applications	Enables access for the Honeywell Mobility SDK for Web apps and port selection.

## Digital Wellbeing & parental controls

In the Settings app, select **Digital Wellbeing & parental controls** to access the following settings. See <https://wellbeing.google/>.

### Google

In the Settings app, select **Google** to set up and manage your Google accounts and services.



## System

In the Settings app, select **System** to access the following settings.

Setting	Description
Language & input	<ul style="list-style-type: none"><li>Set the active language.</li><li>Set and manage Virtual and Physical Keyboard input methods.</li><li>Configure auto-typing features such as capitalization, punctuation, spell check, and the personal dictionary.</li><li>Adjusts the pointer speed.</li><li>Set text-to-speech output.</li></ul>
Gestures	<ul style="list-style-type: none"><li>Turn Jump to Camera On/Off.</li><li>Turn Swipe Up on Home Button On/Off.</li><li>Set the Prevent ringing option. Options: Vibrate, Mute, Do Nothing.</li></ul>
Date & time	Configure all date and time settings. To learn more, see <a href="#">Set the Time Zone</a> on page 27.
Backup	Turn the Google Drive backup feature On or Off. When enabled, phone data (e.g., apps, apps data, call history, contacts, device settings, SMS, Wi-Fi passwords and permissions) is automatically backed up to the Google Drive.
Advanced	
Reset Option	Select from the following reset options: <ul style="list-style-type: none"><li>Reset Wi-Fi, Mobile &amp; Bluetooth. Use to reset all network settings, including Wi-Fi, Mobile data and Bluetooth.</li><li>Reset app preferences. Use to reset app preference back to defaults. This includes apps you disabled, notification changes, default app actions set, background data restrictions for apps, and permission restrictions.</li><li>Enterprise data reset. To learn more, see <a href="#">About an Enterprise Data Reset</a> on page 79.</li><li>Erase all data (factory reset). To learn more, see <a href="#">About a Full Factory Reset</a> on page 80.</li></ul>
Multiple Users	<ul style="list-style-type: none"><li>Modify the owner profile name and add profiles for other people who use the computer.</li><li>Activate a different user profile.</li><li>Enable or disable allowing users to be added from the lock screen.</li></ul>
Developer options	Enable developer-specific options such as USB debugging and SD card protection. This option only appears under System settings if you enable the feature. To learn more, see <a href="#">Unlock Developer Options</a> on page 31.
System update	Check for Android system updates.

## About Phone

In the Settings app, select **About Phone** to access the following information.

Setting	Description
Device name	A nickname to identify the device. To change, tap Device name and enter a new name.

Setting	Description
Phone number*	The phone number(s) assigned to the device.
Emergency information	Emergency medical and contact information that will be displayed on the lock screen in an emergency.
Legal information	Provides links to third-party licenses and other legal information.
Compliance information	Displays certification and compliance information.
SIM status*	Displays information on the SIM card in the device that can be used for diagnostic purposes.
Model & hardware	Displays the model number, serial number, and hardware version of the device.
IMEI*	Displays the International Mobile Equipment Identify number.
Android version	The version of Android on the device. Tap to view additional details.
Asset number	Asset tag assigned to the device.
IP address	IP address associated with the device.
Wi-Fi MAC address	Wi-Fi Mac address associated with the device.
Bluetooth address	Bluetooth address associated with the device.
Up time	Amount of time the mobile computer has been running since the last power up or restart.
Build number	Kernel number installed.
* If your WWAN model supports a dual SIM card setup, both sim slot 1 and sim slot 2 will be listed.	

## About Network Communications

You can easily add the mobile computer to your wireless or wired network. Connect the EDA57 to your computer using:



- 802.11 a/b/g/n/ac radio communication technology
- Ethernet communication technology
- Bluetooth communication technology
- USB communication technology

## Connect to a Wi-Fi Network

The computer contains an 802.11 a/b/g/n/ac radio to transfer data using wireless communications. Before you connect to a Wi-Fi network, you need to know about your network security protocol and its required credentials.

By default, the 802.11 radio is disabled.

1. Swipe up from the bottom of the Home screen to access all apps.
2. Tap **Settings**  > **Network & internet** > **Wi-Fi**.

3. Tap  the toggle button to turn the Wi-Fi radio **On** . A list of discovered networks appears.
4. On the list, tap a network name to initiate a connection.  
To add a network if it does not appear on the list:
  - a. Navigate to the end of the discovered network list, and then tap **Add network**.
  - b. Type the Wi-Fi network name (SSID).
  - c. Choose a security protocol and add any required information.
  - d. Tap **Save**.
5. Enter any required information if the network is secured (e.g., password, key or certificate name).
6. Tap **Connect**.



Once you connect to a saved Wi-Fi network:

- Tap the network name on the list to view details (e.g., status, signal strength, speed, frequency, security type). Select **Cancel** to close details screen.
- The computer automatically connects to the same network when the network is in range and the Wi-Fi radio is turned on.
- To remove a network from your saved list, tap and hold the network name and select **Forget**. You can do this for networks you no longer use.
- To view a list of only your saved networks, tap **Saved networks**.

## Configure Proxy Settings for a Wi-Fi Network

If you need to connect to network resources through a proxy server, you can configure settings for the proxy server for each Wi-Fi network you add. By default, the Wi-Fi networks you add are not configured to connect through a proxy server.

**Note:** Proxy settings apply only to the Wi-Fi network you modify. You must change proxy settings for each network requiring a proxy server.

1. Swipe up from the bottom of the Home screen to access all apps.
2. Tap **Settings**  > **Network & internet** > **Wi-Fi**. The list of available Wi-Fi networks appears.
3. Tap the  icon next to a connected network.
4. Tap the  icon to edit network details.
5. Tap **Advanced options**.
6. Expand the Proxy menu, and then select **Manual**.
7. Enter the proxy settings for the network.
8. Tap **Save**.

## Disable Wi-Fi Notifications

By default, when Wi-Fi is enabled, you receive notifications in the Status bar when the computer discovers a wireless network. You can disable these notifications.

1. Swipe up from the bottom of the Home screen to access all apps.
2. Tap **Settings**  > **Network & internet**. > **Wi-Fi**. Verify the Wi-Fi radio is turned On.
3. Tap **Wi-Fi preferences**. The Configure Wi-Fi menu appears.
4. Tap **Notify for public networks** to toggle the setting On or Off.

## Honeywell Wi-Fi Settings

To access Wi-Fi preference settings for advanced configuration of the wireless 802.11 radio in the mobile computer:

1. Swipe up from the bottom of the Home screen to access all apps.
2. Tap **Settings**  > **Network & internet**. > **Wi-Fi**.
3. Tap **Wi-Fi preferences**. The Configure Wi-Fi menu appears.
4. Tap **Advanced** > **Honeywell Wi-Fi Settings**.
5. Tap a setting to enable or disable the option or to access additional parameters that configure the Wi-Fi radio.

## How to Connect to Virtual Private Networks

The computer supports connecting to virtual private networks (VPNs). This section describes how to add and connect to VPNs. To configure VPN access, you must obtain details from your network administrator. You view and change VPN settings in the Settings app.

**Note:** Before you can add or connect to a VPN, you must enable a screen lock method.

### Add a VPN

Before you can connect to a VPN, you must create a VPN profile.

1. Swipe up from the bottom of the Home screen to access all apps.
2. Tap **Settings**  > **Network & internet** > **Advanced** > **VPN**.
3. Tap **+** to add a new VPN profile.
4. Enter the required information for the VPN connection. If needed, swipe up on the screen to access all the required information fields.
5. Tap **Save**. The VPN name appears in the VPN list.

## Connect to a VPN



Once a VPN profile is created, you can connect to the VPN at any time.

1. Swipe up from the bottom of the Home screen to access all apps.
2. Tap **Settings**  > **Network & internet** > **Advanced** > **VPN**.
3. Tap the name of the VPN in the list.
4. Enter any necessary credentials when prompted.
5. Tap **Connect**.

A  appears in the status bar and a notification is received. To disconnect from the VPN, tap the notification.

## Edit VPN Information

Editing an existing VPN profile is done from the VPN screen.

1. Swipe up from the bottom of the Home screen to access all apps.
2. Tap **Settings**  > **Network & Internet** > **Advanced** > **VPN**.
3. Tap and hold the name of the VPN in the list.
4. Tap  to the right of the VPN profile you want to edit.
5. Edit the VPN settings as necessary.
6. When you are done, tap **Save**.

## About Wireless Security

The computer provides these security solutions for your wireless network:

- Wi-Fi Protected Access 3 (WPA3™)
- Wi-Fi Protected Access 2 (WPA2™)
- Wi-Fi Protected Access (WPA)
- 802.1x
- LEAP
- WEP

Honeywell recommends WPA3 security with SAE (Personal) or 802.1x (Enterprise) key management.

Before you set security, you need to enable the radio, set the date, and set the SSID on your computer. To use 802.1x security, you need to load a root certificate on your computer. To use transport layer security (TLS) with 802.1x security, you also need to load a user certificate.

Use the Settings app to access and configure all wireless security settings.

## About Certificates

You can use digital certificates to identify the computer for network access or authentication to servers. To use a certificate to identify your device, you must install it in the trusted credential storage on the computer.



Android supports DER-encoded X.509 certificates saved in files with a .crt or .cer file extension. To install a valid certificate with a .der or other extension, you must change the extension to .crt or .cer to install it.

Android also supports X.509 certificates saved in PKCS#12 key store files with a .p12 or .pfx extension. To install a valid key store file with another extension, you must change the extension to .p12 or .pfx to install it. When you install a certificate from a PKCS#12 key store, Android also installs any accompanying private key or certificate authority certificates.

## Load a Certificate

To use a certificate, you must install it in the trusted credential storage on the computer.

**Note:** Apps such as email and browsers that support certificates allow you to install certificates directly from within the app. For more information, see the help that comes with the app.

1. Copy the certificate or key store from your PC to the mobile computer.
2. Swipe up from the bottom of the Home screen to access all apps.
3. Tap **Settings**  > **Security** > **Encryption & credentials**.
4. Tap **Install a certificate**.
5. Select either **CA certificate**, **VPN & app user certificate**, or **Wi-Fi certificate**.
6. Tap the Menu icon , and then navigate to the location where you saved the certificate.
7. Tap the certificate or key store to install it. If prompted, enter the key store password and tap **OK**.
8. Enter a name for the certificate and tap **OK**.

## Disable or Remove Certificates

If a user or system certificate is compromised, or your organization chooses not to trust it, you can disable or remove the certificate.

1. Swipe up from the bottom of the Home screen to access all apps.
2. Tap **Settings**  > **Security** > **Encryption & credentials**.

3. Tap **Trusted Credentials**.

The trusted credentials screen has two tabs:

- **System** shows Certificate Authorities (CA) certificates permanently installed on the computer. They can only be disabled.
  - **User** shows CA certificates you have installed yourself. You can remove these certificates.
4. Tap the name of the certificate that you want to disable or remove. The Security certificate screen appears.
  5. Scroll to the bottom of the screen and tap **Disable** (for System certificates) or **Remove** (for User certificates).
  6. Tap **OK**.

**Note:** You can enable a disabled System certificate, but if you remove a User certificate, you must install it again to enable it.

## About Bluetooth Communications

Your mobile computer is equipped to communicate with other devices using Bluetooth technology. The Bluetooth radio must be turned on to discover, pair and connect to other devices using Bluetooth wireless technology. System bar icons indicate Bluetooth radio status.

## Connect a Bluetooth Device

To connect to a Bluetooth device, you must turn On the Bluetooth radio and then select the device from a list of discovered devices.

1. Swipe up from the bottom of the Home screen to access all apps.
  2. Tap **Settings**  > **Connected devices**.
  3. Tap **+** Pair new device. A list of Bluetooth devices appears.
  4. Select a device on the list to initiate a pairing request.
  5. When the pairing request message appears:
    - Verify the pairing PIN is the same on both devices, and then tap **Pair**.
- OR
- If the pairing request requires a PIN, enter the **PIN**, and then tap **Pair**.

When the device is successfully paired with the computer, the device name appears under Previously Connected Devices.

6. (Optional) Once paired to a device, you can connect manually to the device. Tap the device under Paired devices. The word “Connecting” appears under the

paired device name. When a connection is established, the device appears under Other Devices.

**Note:** To delete a paired device, tap  next to the name of the paired device and then tap **Forget**.



## Rename the Computer and View File History

You can change the name of the computer to make it easier to identify when pairing with other Bluetooth enabled devices and view statistics about received files.

1. Swipe up from the bottom of the Home screen to access all apps.
2. Tap **Settings**  > **Connected devices** > **Connection preferences** > **Bluetooth**.
3. Tap **Device Name** to change the device name. Type the new name and then tap **Rename**.

## Rename or Unpair a Paired Device

You can rename a paired device to make it easier to identify on the list or unpair the device to remove it from the paired list.

1. Swipe up from the bottom of the Home screen to access all apps.
2. Tap **Settings**  > **Connected devices** > **Previously connected devices**.
3. Tap  next to the **paired device**.
4. Take one of the following actions:
  - To rename the device, tap the  icon, type the new name, and then tap **RENAME**.
  - To allow **Contact Sharing**, tap the check box next to the setting.
  - To unpair the device, tap **Forget**.

## About USB Communications

You can use these optional accessories to transmit data to and receive data from another device using an Ethernet or USB cable connection:

- Net Bases
- Ethernet Home Bases
- Display Docks
- Snap-on Cup (USB)



Accessory documentation is available for download from the EDA57 product page at [sps.honeywell.com](https://sps.honeywell.com).

For a complete list of compatible accessories for your mobile computer and their part numbers, see the EDA52 *Accessory Guide* available for download at [sps.honeywell.com](https://sps.honeywell.com).

Contact your local sales representative for ordering information.

## USB Troubleshooting

- If you have a problem with your workstation computer recognizing the USB device, try downloading and installing the Honeywell-aidc-usb-driver. The driver is part of the Honeywell\_Mobility SDK\_Android software.zip file. To learn where to get the software, see [Developer Information](#) on page 73.
- Check to make sure you have enabled the USB for file transfer. To learn more, see [Configure USB Connection and Transfer Files](#) on page 19.

## USB, Bluetooth, or Ethernet Tethering for Data Connection Sharing

You can share your mobile computer data connection with another device through a USB, Bluetooth, or Ethernet tethering.

### Minimum requirements for USB Tethering

- Mobile computer minimum operating system version of Android 9 or later.
- A compatible USB communication accessory and/or cable.

### Set up and Connection

1. Connect the devices using a USB accessories and/or cable.
2. On the mobile computer, tap **Settings**  > **Connected devices** > **USB**.
3. Select **USB tethering**, and then tap the back arrow twice.
4. Tap **Network & Internet** > **Hotspot & tethering**.
5. Select **USB tethering** to initiate the shared data connection.

**Note:** To stop sharing the connection, tap **USB tethering** again to turn Off the feature or disconnect the USB accessory.

## Minimum requirements for Bluetooth Tethering

All devices must support Bluetooth communication.

### Set up and Connection

1. Pair the mobile computer with another Bluetooth enabled device.
2. Verify the other device is set to use a network connection using Bluetooth technology.
3. Swipe up from the bottom of the Home screen to access all apps.
4. Tap **Settings**  > **Network & internet** > **Hotspot & tethering**.
5. Select **Bluetooth tethering** to initiate the shared data connection.

**Note:** To stop sharing the connection, tap **Bluetooth tethering** again to turn Off the feature.

## Minimum requirements for Ethernet Tethering

- Mobile computer minimum operating system version of Android 11 or later.
- A compatible USB-to-Ethernet adapter.
- Ethernet cable

### Set up and Connection

1. Plug the Ethernet cable into a router or modem, connect the Ethernet adapter to the cable, and then plug the adapter into the mobile computer.
2. Swipe up from the bottom of the Home screen to access all apps.
3. Tap **Settings**  > **Network & internet** > **Hotspot & tethering**.
4. Select **Ethernet tethering** to initiate the shared data connection.

**Note:** To stop sharing the connection, tap **Ethernet tethering** again to turn Off the feature or disconnect the USB accessory.

## About Near Field Communication (NFC)

NFC technology provides the ability for short-range, wireless data transfer between the computer and NFC tags or other NFC enabled devices placed in close proximity to the back of the computer. All EDA57 mobile computers support the following modes of operation:

- NFC tag reader/writer mode: The computer reads and/or writes digital information from or to an NFC tag.

- Peer-to-Peer (P2P) mode: The computer uses Bluetooth technology to transfer screen content (e.g., a picture, contact information, Web page URL, or file) between NFC enabled devices.
- NFC card emulation mode: The computer emulates an NFC card (smart card) that an external card reader can access. You can download and install apps for card emulation mode from the Google Play™ store. Some examples include digital wallets (e-wallets) offered by your bank or credit card company and Google Pay™. The app you install determines the type of emulation mode used: Card Emulation with a Secure Element or Host-based Card Emulation. Secure element use is common for financial transactions that require a high level of security in order to provide a secure memory and execution environment for running custom smart card applets and storing your personal information (e.g., account information and credentials).

**Note:** When using a Universal Integrated Circuit (UICC) card for NFC Secure Element NFC link encryption, install the card in SIM slot 1.

## Developer Information

To download the Honeywell Mobility SDK for Android and EZConfig for Mobility:

1. Go to the *Technical Support Downloads Portal* at [honeywell.com/PSSsoftware-downloads](https://honeywell.com/PSSsoftware-downloads).
2. Create an account if you have not already created one. You must login to download the software.
3. Install the *Honeywell Download Manager* tool on your workstation (e.g., laptop or desktop computer) prior to trying to download any files.
4. Navigate to the software:
  - *Honeywell Mobility SDK for Android*  
Click on **Software** > **Software and Tools** > **Developer Library** > **SDKs for Android**.
  - *EZConfig for Mobility*  
Click on **Software** > **Software and Tools** > **EZConfig for Mobility**.
5. Select **Download** next to the software zip file.

## About Provisioning Mode

Once you complete the out-of-box initial setup process, Provisioning mode is automatically turned off to improve device security against unwanted modifications to the system.

When Provisioning mode is turned Off (disabled):

- Configuration barcodes do not scan and process.

- \honeywell\autoinstall folders are inaccessible.

**Note:** To learn more about network and security for Honeywell mobile computers with Android operating systems, go to [sps.honeywell.com](https://sps.honeywell.com).

## Enable or Disable Provisioning Mode

1. Swipe up from the bottom of the Home screen to access all apps.
2. Tap **Settings**  > **Honeywell Settings** > **Provisioning mode**.
3. Tap the button to toggle the provisioning **On** or **Off**.

# MANAGE AND MAINTAIN THE COMPUTER

Use this chapter to understand how to upgrade software and to reset and maintain the computer.

## About Software Updates

Cyber security best practices include keeping your device apps and OS up to date. To help, Honeywell offers maintenance patches, security updates and operating system upgrades through our Honeywell Edge services.

Availability and cost depend on the following:

- Date of purchase of the device or software app.
- Warranty status.
- Service agreement status (devices) or Maintenance plan status (apps).

To learn more about Honeywell Edge Services, go to <https://sps.honeywell.com/us/en/services/productivity/support-services>.

## Software Downloads

Product support is available online through [Technical Support](#). Software updates can be accessed through the [Software Downloads](#) portal. You will need to create a login account for portal access. Additional information such as purchased date, service agreement number, maintenance plan number, or software license number may be required for downloads.

1. Go to [honeywell.com/PSSsoftware-downloads](https://honeywell.com/PSSsoftware-downloads).
2. Create a login account if you have not already created one.
3. Install the Honeywell Download Manager tool. See “Note” on the portal page. This tool is required for downloads.
4. Locate the app or upgrade you want to download in the Software directory.
5. If prompted, enter additional information, and click **Submit**.



6. Select **Download**. Follow the prompts to download the file.

## About Transferring Files via USB Connection

If you plan on using a USB connection to transfer files to the mobile computer, make sure you set the USB connection to allow file transfers. To learn more, see [Configure USB Connection and Transfer Files](#) on page 19.

## Install Software Apps with AutoInstall

**Important:** *The mobile computer must have power for the entire length of the install process or it could become unstable. Do not attempt to remove the battery during the process.*

1. Swipe up from the bottom of the Home screen to access all apps.
2. Tap **Settings**  > **Honeywell Settings** > **Provisioning mode**.
3. Tap the toggle button to turn Provisioning mode **On**.
4. Save the Android application file (\*.zip or \*.apk) in one of the following folders on the mobile computer:
  - **Internal shared storage\honeywell\autoinstall**  
Files saved to this folder for installation do not persist when a Full factory reset or Enterprise data reset is performed.
  - **IPSM card\honeywell\autoinstall**  
Files saved to this folder for installation do not persist when a Full factory reset is performed. However, the software does persist if an Enterprise data reset is performed.
5. Swipe up from the bottom of the Home screen to access all apps.
6. Tap **AutoInstall Settings**  and verify **Enable Autoinstall** is enabled .
7. Tap **Packages Update** from the AutoInstall Settings screen.



If required by the app, the computer may automatically initiate a reboot before starting the installation process. When the installation is finished, a message appears or the unit finishes rebooting and the lock screen appears.
8. Once installation is complete, turn Provisioning mode **Off**.

**Note:** *Some updates do not require the computer to reboot before installation.*

## Optional microSD Card Method

The mobile computer comes equipped with a microSD card socket. You can install an upgrade from a microSD card you insert in the computer.

**Important:** *The computer must have power for the entire length of the install process or it could become unstable. Do not attempt to remove the battery during the process.*

1. On the computer, swipe up from the bottom of the Home screen to access all apps.
2. Tap **Settings**  > **Honeywell Settings** > **Provisioning mode**.
3. Tap the toggle button to turn Provisioning mode **On**.
4. Tap **AutoInstall Settings** . Verify **Enable Autoinstall** is enabled .
5. Press and hold the **Power** button, and then tap **Power off**.
6. On your workstation (e.g., laptop, desktop computer), format the microSD card and create a **\honeywell\autoinstall** folder on the root of the card.
7. Save the upgrade file in the **autoinstall** folder.
8. Install the microSD card in the computer, and then press the **Power** button.

The computer automatically runs the upgrade found in the autoinstall folder on the card. The system update screen appears during the upgrade process. When the upgrade is finished, the lock screen appears.

9. Once installation is complete, turn Provisioning mode **Off**.

## About the Honeywell Upgrader

Use the Honeywell Upgrader app (HUpgrader) to check for and install OTA updates, and view the current OTA version installed on the computer.

## Install OTA Updates

To use the HUpgrader to install an OTA update file downloaded from the [Technical Support Downloads Portal](#):

1. Save the OTA file (\*.zip) to the following folder on the computer:
  - **Internal shared storage\Download**

2. Tap **HUpgrader**  to open the Honeywell Upgrader app.

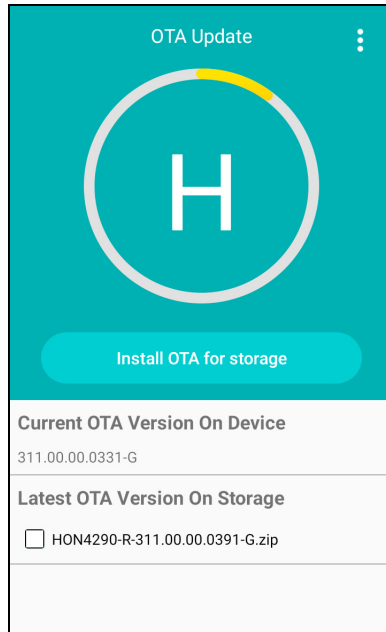

3. Tap , and then tap **Choose OTA from storage**.
4. Select the storage location (i.e., Internal Storage) where you saved the file.
5. Tap the OTA update file. The computer examines the file, and then starts the installation.

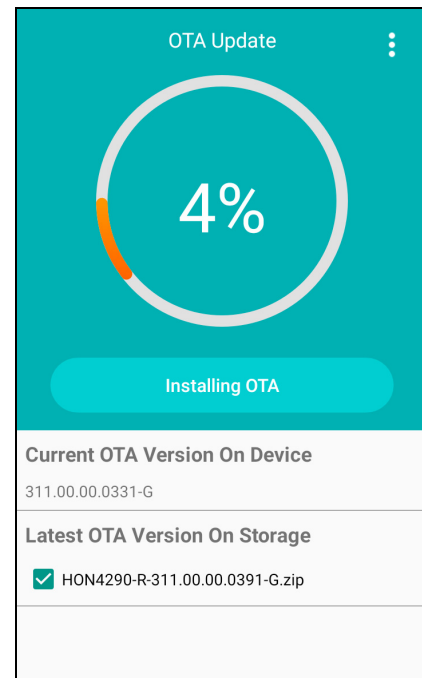
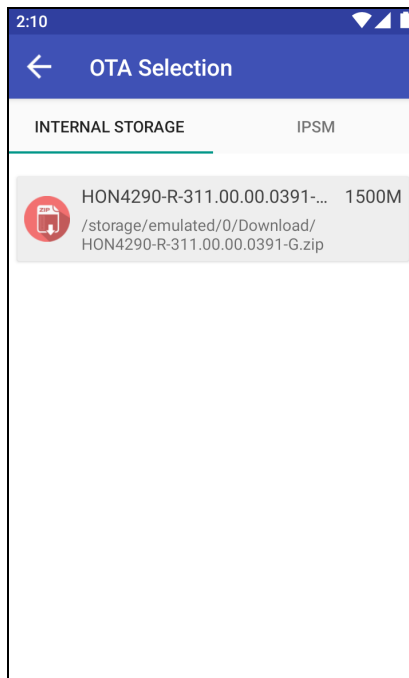

6. Once the installation is complete (100%), select **OK** when prompted to **Reboot** the computer. The computer reboots and finishes the update.



# Restart (Reboot) the Computer

You may need to reboot the computer to correct conditions where an application stops responding to the system.

1. Save your files and close any open applications.
2. Press and hold the **Power** button until the options screen appears.
3. Tap **Restart**. The computer restarts.

If the touch panel display is unresponsive:

- Press and hold the **Power** button for approximately 8 seconds until the computer reboots.

## About an Enterprise Data Reset

You can perform an Enterprise data reset if a Reboot did not improve the condition and all other troubleshooting methods have not resolved the issue. This method provides a clean configuration for troubleshooting by erasing all data from the Internal shared storage location on the computer. Data is not erased from the IPSM Card location.





**Caution:** An Enterprise data reset results in data loss. Only perform this procedure if all other recovery methods have failed. All personal content is erased including, but not limited to emails, pictures, contacts, Google account information, system settings, and app settings.

**Note:** *This method of recovery may not be available if your system administrator has set policies to prevent the reset use.*

## Before You Begin

- If you recently reset your Google Account password, wait 24 hours before performing an Enterprise data reset.
- Make sure you have your screen lock password, PIN or pattern if you activated one. You will need this to reset the computer.
- If you have a Google Account, back up your data and settings to your Google Account so you can restore them if needed.
- Connect the computer to an external power source or make sure you have a full battery charge.
- Make sure you have an Internet connection.

# Enterprise Data Reset the Computer

1. Swipe up from the bottom of the Home screen to access all apps.
2. Select **Settings**  > **System** > **Advanced** > **Reset options**.
3. Tap **Reset enterprise data**.
4. Tap **Erase all data**.
5. If prompted, type your screen lock security pattern, PIN, or password, and tap next (  ).
6. Tap **Erase all data**. A message appears informing you an Enterprise data reset is being performed.

## About a Full Factory Reset

A full factory reset should only be performed if you have exhausted all other troubleshooting options. This method reverts the computer back to the factory state by erasing all data in Internal shared storage and the IPSM Card storage locations on the computer.





**Caution:** A Full factory reset results in data loss. Perform this procedure only if all other recovery methods have failed and you have no other option. All personal content is erased including, but not limited to emails, pictures, contacts, Google account information, system settings, and app settings.

**Note:** *This method of recovery may not be available if your system administrator has set policies to prevent the reset use.*

## Before You Begin

- If you added a Google Account to the computer, make sure you have your Google username and password associated with the computer. If you do not have the username and password, you will not be able to use the computer after the reset. This is a security measure that prevents unauthorized users from using the device if they try a Full factory reset.
- If you did not add a Google Account to the computer, the extra security level is not enabled and you will not need a Google username and password.
- If you recently reset your Google Account password, wait 24 hours before performing a Full factory reset.
- Connect the computer to an external power source or make sure you have a full battery charge.
- Make sure you have an Internet connection.

## Full Factory Reset the Computer

1. Swipe up from the bottom of the Home screen to access all apps.
2. Select **Settings**  > **System** > **Advanced** > **Reset options**.
3. Tap **Erase all data (factory reset)**.
4. Tap **Erase all data**.
5. If prompted, type your screen lock security pattern, PIN, or password and tap next (  ).
6. Tap **Erase all data**. A message appears informing you an Enterprise data reset is being performed.

## Repairs

Repairs and/or upgrades are not to be performed on this product. These services are to be performed only by an authorized service center (see [Customer Support](#) on page ix).

## Maintenance

Your device provides reliable and efficient operation with a minimum of care. Although specific maintenance is not required, the following sections describe periodic checks to ensure dependable operation.

## Clean the Computer

The computer housing, scanner window, camera window, and touch screen may be cleaned with a soft cloth dampened with water or a mild detergent-water solution. If a mild detergent solution is used, wipe the computer with a clean cloth dampened only with water to remove any detergent residue.

**Note:** *Reading performance may degrade if the scanner window is not clean. If the window is visibly dirty, or if the scanner is not operating well, clean the window.*



**Caution:** Do not submerge the computer in water or cleaning solution.

**Caution:** Do not use abrasive wipes or cloths on the windows or touch screen. Abrasive wipes may scratch the windows and touch screen. Never use solvents (e.g., acetone) on the housing or window. Solvents may damage the computer finish, the windows or touch screen.

**Caution:** Ensure all components are dry prior to mating the computer with charging accessories or other peripheral devices. Mating wet components may cause damage not covered by the warranty.

## Computer Agency Information

The EDA57 mobile computer meets or exceeds the requirements of all applicable standards organizations for safe operation. The best way to ensure safe operation is to use the mobile computer according to the agency guidelines on the product regulatory sheet, quick start guide, battery insert, and in this user guide. Read all guidelines before using your computer.

Product documentation is available for download from [sps.honeywell.com](https://sps.honeywell.com).

Public certificates are available for download from [honeywell.com/PSScompliance](https://honeywell.com/PSScompliance).

## Label Locations

Labels inside the battery compartment contain information about the computer, including compliance information, model number, serial number, and MAC address. Laser safety labeling is located on the back of the computer.

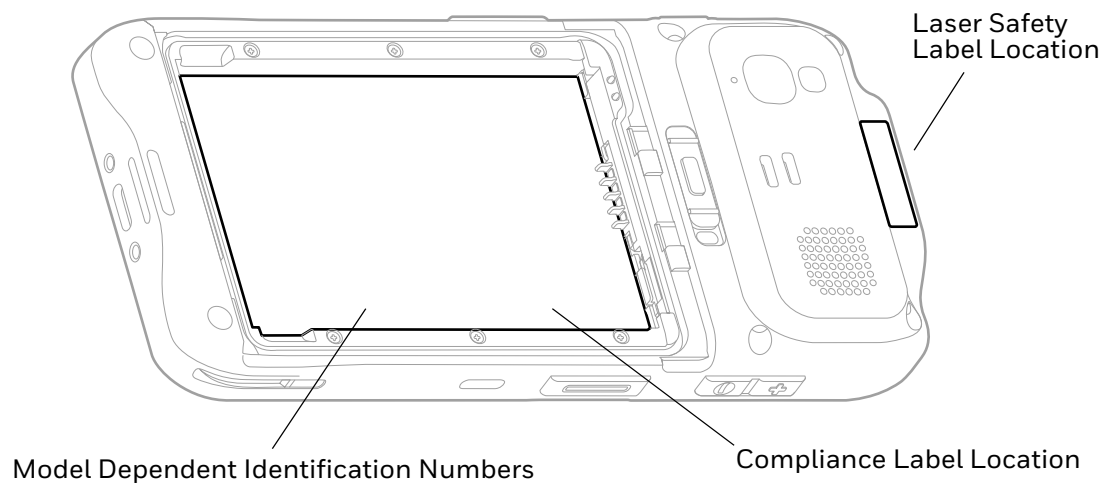

# Physical and Environmental Specifications

1. Go to [sps.honeywell.com](https://sps.honeywell.com).
2. Type EDA57 in the Search box, and then press **Enter**.
3. Click on the product link in the search results.
4. Select one of the following tabs:
  - **Specifications**  
View System Architecture, Wireless Connectivity, Mechanical, and Environmental specifications.
  - **Resources**  
View and download available product documentation. For example, Data Sheet, Accessory Guide, Quick Start Guide, User Guide, Regulatory Information, Battery Information.

## Imager Specifications

The computer is equipped with the following Honeywell high-performance imager:

- S0703-SR Standard Range Imager

## Barcode Symbolologies

The computer supports the following barcode symbolologies:

1D Symbolologies		2D Symbolologies		Postal Codes	
	Default		Default		Default
Codabar	Enabled	Aztec Code	Enabled	China Post	Disabled
Code 39	Enabled	Codablock A	Disabled	Korean Post	Disabled
Code 11	Disabled	Codablock F	Disabled	2D Postal	Disabled
Code 93	Disabled	DataMatrix	Enabled		
Code 128	Enabled	DotCode	Disabled		
Composite	Disabled	Grid Matrix	Disabled		
EAN-8	Enabled	HanXin	Disabled		
EAN-13	Enabled	Maxicode	Disabled		
GS1-128	Enabled	Micro PDF 417	Disabled		
GS1 DataBar	Disabled	PDF 417	Enabled		
IATA 2 of 5	Disabled	QR Code	Enabled		
Standard 2 of 5	Disabled	OCR	Disabled		
Interleaved 2 of 5	Enabled	Digimarc	Disabled		
Matrix 2 of 5	Disabled	TLC 39	Disabled		

1D Symbologies		2D Symbologies		Postal Codes	
	Default		Default		Default
MSI	Disabled				
Telepen	Disabled				
Trioptic	Disabled				
UPC/EAN	Enabled				
UPC-A	Enabled				
UPC-E	Enabled				

**Note:** To learn about changing the symbology settings, see [Change the Scanner Settings](#) on page 34.

## S0703-SR Standard Range Imager

The depth of field measurements used the following parameters:

- Distances are measured from the front of the Imager.
- +23 °C (+73 °F), 0 lux for guaranteed, 200 lux for typical.
- Photographic quality codes.

**Note:** Time to Read and Depth of Field are impacted if the barcode symbol is at the edge of the image.

### Guaranteed Specs

Focus		Standard Range	
Symbology		Near Distance	Far Distance
5 mils Code 39	mm	79	270
	in.	3.11	10.63
10 mils Code 39	mm	40	425
	in.	1.57	16.73
20 mils Code 39	mm	44	674
	in.	1.73	26.53
13 mils 100% UPC-A	mm	44	493
	in.	1.73	19.41
15 mils Code 128	mm	42	572
	in.	1.65	22.52
10 mils Data Matrix	mm	83.1	236
	in.	3.27	9.29
5 mils PDF 417	mm	119	177.04
	in.	4.68	6.97

Focus		Standard Range	
Symbology		Near Distance	Far Distance
6.7 mils PDF 417	mm	96.01	236
	in.	3.78	9.29
15 mils QR	mm	39	390
	in.	1.54	15.35

### Typical Specs

Focus		Standard Range	
Symbology		Near Distance	Far Distance
5 mils Code 39	mm	70	301
	in.	2.75	11.85
10 mils Code 39	mm	40	517
	in.	1.57	20.35
20 mils Code 39	mm	44	800
	in.	1.73	31.5
13 mils 100% UPC-A	mm	44	573
	in.	1.73	22.56
15 mils Code 128	mm	42	650
	in.	1.65	25.59
10 mils Data Matrix	mm	72	297
	in.	2.83	11.69
6.7 mils PDF 417	mm	84	244
	in.	3.31	9.61
15 mils QR	mm	39	414
	in.	1.54	16.30

## S0703-SR Standard Range Imager Field of View/Resolution

Focus	Standard Range (SR)
Horizontal Field Angle (degrees)	44 ± 2°
Vertical Field Angle (degrees)	28 ± 2°

*DPI can be calculated based on the following formula:*

*Horizontal DPI = 1280 pixels/width of horizontal field of view (inches)*

*Vertical DPI = 800 pixels/width of vertical field of view (inches)*





Honeywell  
855 S. Mint St.  
Charlotte, NC 28202

[sps.honeywell.com](https://sps.honeywell.com)