

Lenovo ThinkSystem SR650 V3 Server Product Guide

The Lenovo ThinkSystem SR650 V3 is an ideal 2-socket 2U rack server for small businesses up to large enterprises that need industry-leading reliability, management, and security, as well as maximizing performance and flexibility for future growth. The SR650 V3 is based on the new 5th generation Intel Xeon Scalable processor family (formerly codenamed "Emerald Rapids").

The SR650 V3 is designed to handle a wide range of workloads, such as databases, virtualization and cloud computing, virtual desktop infrastructure (VDI), infrastructure security, systems management, enterprise applications, collaboration/email, streaming media, web, and HPC.



Figure 1. Lenovo ThinkSystem SR650 V3 with 2.5-inch front drive bays (3.5-inch drive configurations also available)

[360° View](#)

[Full 3D Tour](#)

Did you know?

The SR650 V3 server has been designed to take advantage of the features of the 5th generation Intel Xeon Scalable processors, such as the full performance of 385W 64-core processors, support for 5600 MHz memory and PCIe Gen 5.0 support. The SR650 V3 is a very configuration-rich offering, supporting more than 30 different drive bay configurations in the front, middle and rear of the server and 5 different slot configurations at the rear of the server. This level of flexibility ensures that you can configure the server to meet the needs of your workload.

Key features

Combining performance and flexibility, the SR650 V3 server is a great choice for enterprises of all sizes. The server offers a broad selection of drive and slot configurations and offers numerous high performance features. Outstanding reliability, availability, and serviceability (RAS) and high-efficiency design can improve your business environment and can help save operational costs.

Scalability and performance

The SR650 V3 offers numerous features to boost performance, improve scalability and reduce costs:

- Supports one or two fifth-generation Intel Xeon Processor Scalable processors
 - Up to 64 cores and 128 threads
 - Core speeds of up to 3.9 GHz
 - TDP ratings of up to 385 W
- Supports one or two fourth-generation Intel Xeon Processor Scalable processors
 - Up to 60 cores and 120 threads
 - Core speeds of up to 3.7 GHz
 - TDP ratings of up to 350 W
- Support for DDR5 memory DIMMs to maximize the performance of the memory subsystem:
 - Up to 32 DDR5 memory DIMMs, 16 DIMMs per processor
 - 8 memory channels per processor (2 DIMMs per channel)
 - Supports 1 DIMM per channel operating at 5600 MHz (5th Gen processors) or 4800 MHz (4th Gen processors)
 - Supports 2 DIMMs per channel operating at 4800 MHz (5th Gen processors) or 4400 MHz (4th Gen processors)
 - Using 256GB 3DS RDIMMs, the server supports up to 8TB of system memory
- Supports up to eight single-width GPUs or three double-wide GPUs, for substantial processing power in a 2U system.
- The server is Compute Express Link (CXL) v1.1 Ready. With CXL 1.1 for next-generation workloads, you can reduce compute latency in the data center and lower TCO. CXL is a protocol that runs across the standard PCIe physical layer and can support both standard PCIe devices as well as CXL devices on the same link.
- Supports up to 40x 2.5-inch hot-swap drive bays, by using combinations of front-accessible (up to 24 bays), mid bays (8 bays) and rear-accessible (8 bays).
- Supports 20x 3.5-inch drive bays for lower-cost high-capacity HDD storage. 2.5-inch and 3.5-inch drive bays can be mixed if desired.
- Supports 36x NVMe drives without oversubscription of PCIe lanes (1:1 connectivity). The use of NVMe drives maximizes drive I/O performance, in terms of throughput and latency.
- Supports 14x SATA drives using the onboard SATA controller (no additional adapter needed), enabling lower cost, high capacity storage solution for cold or archival storage workloads.
- Supports high-speed RAID controllers from Broadcom providing 12 Gb SAS connectivity to the drive backplanes. A variety of PCIe 3.0 and PCIe 4.0 RAID adapters are available.
- Supports up to two externally accessible 7mm hot-swap drives for operating system boot functions. Optional RAID with the use of Intel VROC.
- Supports M.2 drives for convenient operating system boot functions or data storage. Available M.2 adapters support either one M.2 drive or two M.2 drives. Optional RAID with the use of Intel VROC.
- Up to 12x PCIe slots (10x rear, 2x front), plus a slot dedicated to an OCP 3.0 adapter. 2.5-inch drive configurations also support an additional internal bay for a cabled RAID adapter or HBA.
- The server has a dedicated industry-standard OCP 3.0 small form factor (SFF) slot, supporting a variety of Ethernet network adapters. A simple-swap mechanism with a thumbscrew and pull-tab enables tool-less installation and removal of the adapter. The adapter supports shared BMC network sideband connectivity to enable out-of-band systems management.

- The server offers PCI Express 5.0 I/O expansion capabilities that doubles the theoretical maximum bandwidth of PCIe 4.0 (32GT/s in each direction for PCIe Gen 5, compared to 16 GT/s with PCIe Gen 4 and 8 GT/s with PCIe Gen 3). A PCIe 5.0 x16 slot provides 128 GB/s bandwidth, enough to support a dual-port 200GbE network connection.

Availability and serviceability

The SR650 V3 provides many features to simplify serviceability and increase system uptime:

- Designed to run 24 hours a day, 7 days a week
- The server offers Single Device Data Correction (SDDC, also known as Chipkill), Adaptive Double-Device Data Correction (ADDDC, also known as Redundant Bit Steering or RBS), and memory mirroring for redundancy in the event of a non-correctable memory failure. Note: ADDDC is not supported with 9x4 RDIMMs.
- The server offers hot-swap drives, supporting RAID redundancy for data protection and greater system uptime.
- Available M.2 adapters support RAID-1 (using Intel VROC) which can enable two SATA or two NVMe M.2 drives to be configured as a redundant pair.
- The server has up to two hot-swap redundant power supplies and up to six hot-swap redundant fans to provide availability for business-critical applications.
- Optional front-accessible slots and drives so that most major components and cables (except power) are located at the front of the server
- The light path diagnostics feature uses LEDs to lead the technician to failed (or failing) components, which simplifies servicing, speeds up problem resolution, and helps improve system availability.
- Solid-state drives (SSDs) offer more reliability and performance than traditional mechanical HDDs for greater uptime.
- Proactive Platform Alerts (including PFA and SMART alerts): Processors, voltage regulators, memory, internal storage (SAS/SATA HDDs and SSDs, NVMe SSDs, M.2 storage, flash storage adapters), fans, power supplies, RAID controllers, server ambient and subcomponent temperatures. Alerts can be surfaced through the XClarity Controller to managers such as Lenovo XClarity Administrator, VMware vCenter, and Microsoft System Center. These proactive alerts let you take appropriate actions in advance of possible failure, thereby increasing server uptime and application availability.
- The built-in XClarity Controller continuously monitors system parameters, triggers alerts, and performs recovery actions in case of failures to minimize downtime.
- Built-in diagnostics in UEFI, using Lenovo XClarity Provisioning Manager, speed up troubleshooting tasks to reduce service time.
- Lenovo XClarity Provisioning Manager supports diagnostics and can save service data to a USB key drive or remote CIFS share folder for troubleshooting and reduce service time.
- Auto restart in the event of a momentary loss of AC power (based on power policy setting in the XClarity Controller service processor)
- Offers a diagnostics port on the front of the server to allow you to attach an external diagnostics handset for enhanced systems management capabilities.
- Support for the XClarity Administrator Mobile app running on a supported smartphone or tablet and connected to the server through the service-enabled USB port, enables additional local systems management functions.
- Three-year or one-year customer-replaceable unit and onsite limited warranty (varies by geography), 9 x 5 next business day. Optional service upgrades are available.

Manageability and security

Systems management features simplify local and remote management of the SR650 V3:

- The server includes XClarity Controller 2 (XCC2) to monitor server availability. Optional upgrade to XCC Platinum to provide remote control (keyboard video mouse) functions, support for the mounting of remote

media files (ISO and IMG image files), boot capture, power capping and new XCC2 Platinum features. New XCC2 Platinum features include System Guard, new security modes including a CNSA-compliant mode, a FIPS 140-3-compliant mode and enhanced NIST 800-193 support, and a new Neighbor Group feature.

- Dedicated Ethernet port at the rear of the server for remote management (BMC management).
- Lenovo XClarity Administrator offers comprehensive hardware management tools that help to increase uptime, reduce costs and improve productivity through advanced server management capabilities.
- UEFI-based Lenovo XClarity Provisioning Manager, accessible from F1 during boot, provides system inventory information, graphical UEFI Setup, platform update function, RAID Setup wizard, operating system installation function, and diagnostic functions.
- Support for Lenovo XClarity Energy Manager, which captures real-time power and temperature data from the server and provides automated controls to lower energy costs.
- An integrated industry-standard Unified Extensible Firmware Interface (UEFI) enables improved setup, configuration, and updates, and simplifies error handling.
- Support for industry standard management protocols, IPMI 2.0, SNMP 3.0, Redfish REST API, serial console via IPMI
- An integrated hardware Trusted Platform Module (TPM) supporting TPM 2.0 enables advanced cryptographic functionality, such as digital signatures and remote attestation.
- Administrator and power-on passwords help protect from unauthorized access to the server.
- Supports Secure Boot to ensure only a digitally signed operating system can be used. Supported with HDDs and SSDs, as well as 7mm and M.2 drives.
- Industry-standard Advanced Encryption Standard (AES) NI support for faster, stronger encryption.
- Intel Execute Disable Bit functionality can prevent certain classes of malicious buffer overflow attacks when combined with a supported operating system.
- Intel Trusted Execution Technology provides enhanced security through hardware-based resistance to malicious software attacks, allowing an application to run in its own isolated space, protected from all other software running on a system.
- Additional physical security features are an available chassis intrusion switch and available lockable front bezel.

Energy efficiency

The SR650 V3 offers the following energy-efficiency features to save energy, reduce operational costs, and increase energy availability:

- The server supports an advanced direct-water cooling (DWC) capability with the Lenovo Neptune Processor DWC Module, where heat from the processors is removed from the rack and the data center using an open loop and coolant distribution units, resulting in lower energy costs
- Energy-efficient system board components help lower operational costs.
- High-efficiency power supplies with 80 PLUS Platinum and Titanium certifications
- Solid-state drives (SSDs) consume as much as 80% less power than traditional spinning 2.5-inch HDDs.
- The server uses hexagonal ventilation holes, which can be grouped more densely than round holes, providing more efficient airflow through the system and thus keeping your system cooler.
- Optional Lenovo XClarity Energy Manager provides advanced data center power notification, analysis, and policy-based management to help achieve lower heat output and reduced cooling needs.

Comparing the SR650 V3 to the SR650 V2

The ThinkSystem SR650 V3 improves on the previous generation SR650 V2, as summarized in the following table.

Table 1. Comparing the ThinkSystem SR650 V3 to the previous generation SR650 V2

Feature	SR650 V2	SR650 V3	Benefits
Processor	<ul style="list-style-type: none"> • 2x 3rd Gen Intel Xeon Scalable Processors • Up to 40 cores • TDP ratings up to 270W • 64x PCIe 4.0 lanes per processor 	<ul style="list-style-type: none"> • 2x 4th Gen Intel Xeon Scalable Processors • Up to 60 cores • TDP ratings up to 385W • 80x PCIe 5.0 lanes per processor 	<ul style="list-style-type: none"> • Significant increase in cores per processor • Increased performance • Consolidation of more apps on same number of servers, reducing costs • New PCIe 5.0 support means higher performance networking and NVMe storage
Memory	<ul style="list-style-type: none"> • DDR4 memory operating up to 3200 MHz • 8 channels per CPU • 32 DIMMs (16 per processor), 2 DIMMs per channel • Supports RDIMMs and 3DS RDIMMs • Up to 8TB of system memory • Intel Optane Persistent Memory 200 Series 	<ul style="list-style-type: none"> • DDR5 memory operating up to 4800 MHz • 8 channels per CPU • 32 DIMMs (16 per processor), 2 DIMMs per channel • Supports RDIMMs, 3DS RDIMMs and 9x4 RDIMMs • Up to 8TB of system memory • No support for Intel Optane Persistent Memory 	<ul style="list-style-type: none"> • New DDR5 memory offers significant performance improvements over DDR4 • Support for lower-cost 9x4 DIMMs
Internal storage	<ul style="list-style-type: none"> • 20x 3.5" SAS/SATA/NVMe (12 front, 4 mid, 4 rear) • 40x 2.5" SAS/SATA/NVMe (24 front, 8 mid, 8 rear) • Up to 4x 3.5" or 8x 2.5" mid-chassis drive bays • Up to 4x 3.5" or 8x 2.5" rear drive bays • 2x Internal M.2 with optional RAID • 8x Onboard NVMe ports • NVMe Retimer adapters for 16x NVMe • 2x rear 7mm hot swap SAS/SATA/NVMe; optional RAID 	<ul style="list-style-type: none"> • 20x 3.5" SAS/SATA/NVMe (12 front, 4 mid, 4 rear) • 40x 2.5" SAS/SATA/NVMe (24 front, 8 mid, 8 rear) • Up to 4x 3.5" or 8x 2.5" mid-chassis drive bays • Up to 4x 3.5" or 8x 2.5" rear drive bays • 2x Internal M.2 with optional RAID 1 (RAID support via VROC) • 20x Onboard NVMe ports • NVMe Retimer adapters for 16x NVMe • 2x rear 7mm hot swap SAS/SATA/NVMe (RAID support via VROC) 	<ul style="list-style-type: none"> • Flexible storage offerings • Up to 32x NVMe drives for high-performance storage • 7mm hot swap drives as boot drives

Feature	SR650 V2	SR650 V3	Benefits
RAID	<ul style="list-style-type: none"> 8-, 16- and 32-port RAID adapters with up to 8GB flash Support for Lenovo and Broadcom adapters Support for PCIe or Internal cabled (CFF) form factor adapters Support for NVMe drives connected to 940 RAID adapters (Tri-Mode) Storage HBAs available PCIe Gen 3 and Gen 4 adapter choices 	<ul style="list-style-type: none"> 8-, 16- and 32-port RAID adapters with up to 8GB flash Support for Lenovo and Broadcom adapters Support for PCIe or Internal cabled (CFF) form factor adapters Support for NVMe drives connected to 940 RAID adapters (Tri-Mode) Storage HBAs available PCIe Gen 3 and Gen 4 adapter choices with support for Gen 5 adapters when available 	<ul style="list-style-type: none"> Consistent RAID/HBA support Flexible config solution PCIe Gen 5 allows for greater storage performance
Networking	<ul style="list-style-type: none"> OCP 3.0 slot with PCIe Gen 4 x16 interface (rear of server) Additional PCIe adapters supported 1GbE dedicated Management port 	<ul style="list-style-type: none"> OCP 3.0 slot with PCIe Gen 5 x16 interface (rear) or PCIe Gen4 x16 interface (front) Additional PCIe adapters supported 1GbE dedicated Management port 	<ul style="list-style-type: none"> Improved performance with PCIe Gen 5 Optional front-accessible OCP slot
PCIe	<ul style="list-style-type: none"> Supports PCIe 4.0 Up to 8x PCIe slots (all full-height slots) Supports a RAID/HBA in CFF form factor (does not occupy a PCIe slot) Additional OCP 3.0 slot 	<ul style="list-style-type: none"> Supports PCIe 5.0 Up to 10x PCIe slots (6x full height, 4x low-profile) or 8x PCIe slots (all full-height slots) Up to 9x slots can be PCIe 5.0 Supports a RAID/HBA in CFF form factor (does not occupy a PCIe slot) Additional OCP 3.0 slot Support for 3x front-accessible slots (2x FH PCIe + 1x OCP) with 16 drive bays 	<ul style="list-style-type: none"> PCIe Gen 5 allows for greater I/O performance Flexible PCIe offerings Front-accessible slots available More PCIe connections for greater PCIe/NVMe support
GPU support	<ul style="list-style-type: none"> Supports up to 8x single-wide GPUs or up to 3x double-wide GPUs 	<ul style="list-style-type: none"> Supports up to 8x single-wide GPUs or up to 3x double-wide GPUs 	<ul style="list-style-type: none"> High performance GPU support
Management and security	<ul style="list-style-type: none"> XClarity Controller Support for full XClarity toolset including XClarity Administrator Platform Firmware Resiliency (PFR) hardware Root of Trust (RoT) Tamper Switch security solution (intrusion switch) 	<ul style="list-style-type: none"> Integrated XClarity Controller 2 Support for full XClarity toolset including XClarity Administrator Platform Firmware Resiliency (PFR) hardware Root of Trust (RoT) Tamper Switch security solution (intrusion switch) 	<ul style="list-style-type: none"> New XCC2 offers improved management capabilities Same system management tool with previous generation Silicon-level security solution

Feature	SR650 V2	SR650 V3	Benefits
Power	<ul style="list-style-type: none"> Choice of 500W, 750W, 1100W, 1800W AC Hot Plug PSUs Available in Titanium and Platinum efficiency levels 1100W -48VDC Platinum general support 240V HVDC support for PRC customers Active-Standby mode 	<ul style="list-style-type: none"> Choice of 750W, 1100W, 1800W, 2400W, 2600W AC Hot Plug PSUs Available in Titanium and Platinum efficiency levels 1100W -48VDC Platinum general support 240V HVDC support for PRC customers Active-Standby mode 	<ul style="list-style-type: none"> Multiple PSU offerings to suit the configuration selected New ErP Lot 9-compliant offerings Support for Telco customers with -48V requirements

Components and connectors

The following figure shows the front of the SR650 V3.

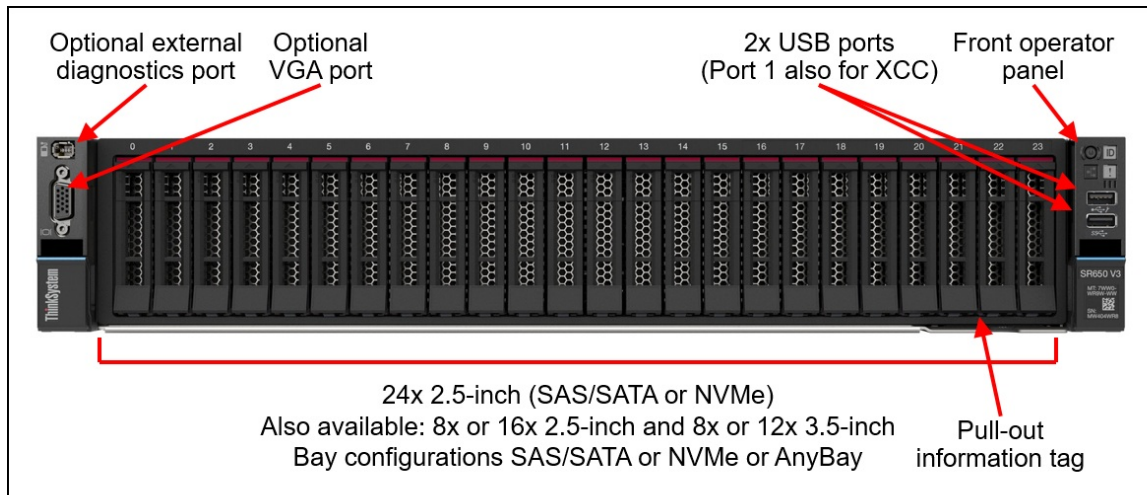

Figure 2. Front view of the ThinkSystem SR650 V3 with 2.5-inch drive bays

For details on the front ports, including the optional front VGA port and optional external diagnostic port, see the [Local management](#) section.

The following figure shows the front configurations of the SR650 V3. The server supports either 2.5-inch hot-swap drives (8, 16 or 24 drive bays) or 3.5-inch hot-swap drives (8 or 12 bays) at the front. The server also supports three front PCIe slots (2 full-height, 1 OCP) in addition to 16x 2.5-inch drive bays.

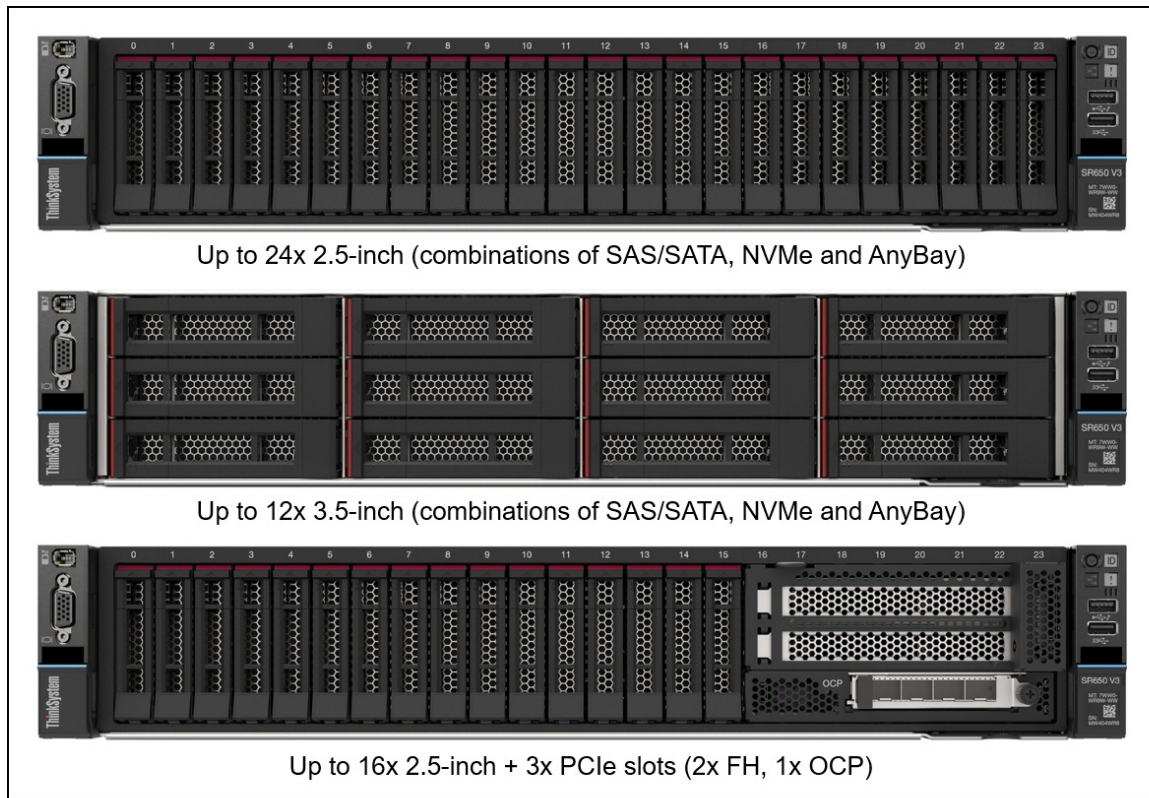

Figure 3. Front view of the ThinkSystem SR650 V3

The following figure shows the components visible from the rear of the server. The figure shows one configuration, with eight PCIe slots, however there are additional rear configurations which include 3.5-inch drive bays, 2.5-inch drive bays, or 7mm drive bays.

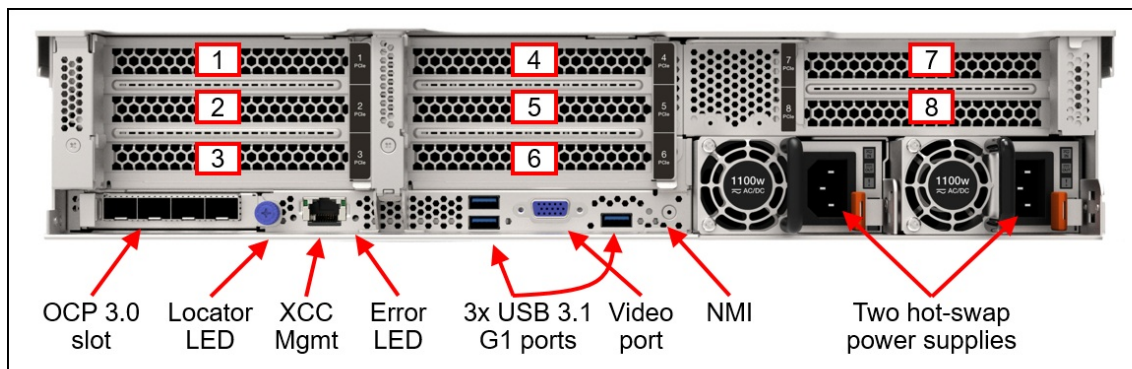

Figure 4. Rear view of the ThinkSystem SR650 V3 (configuration with eight PCIe slots)

The following figure shows the locations of key components inside the server.

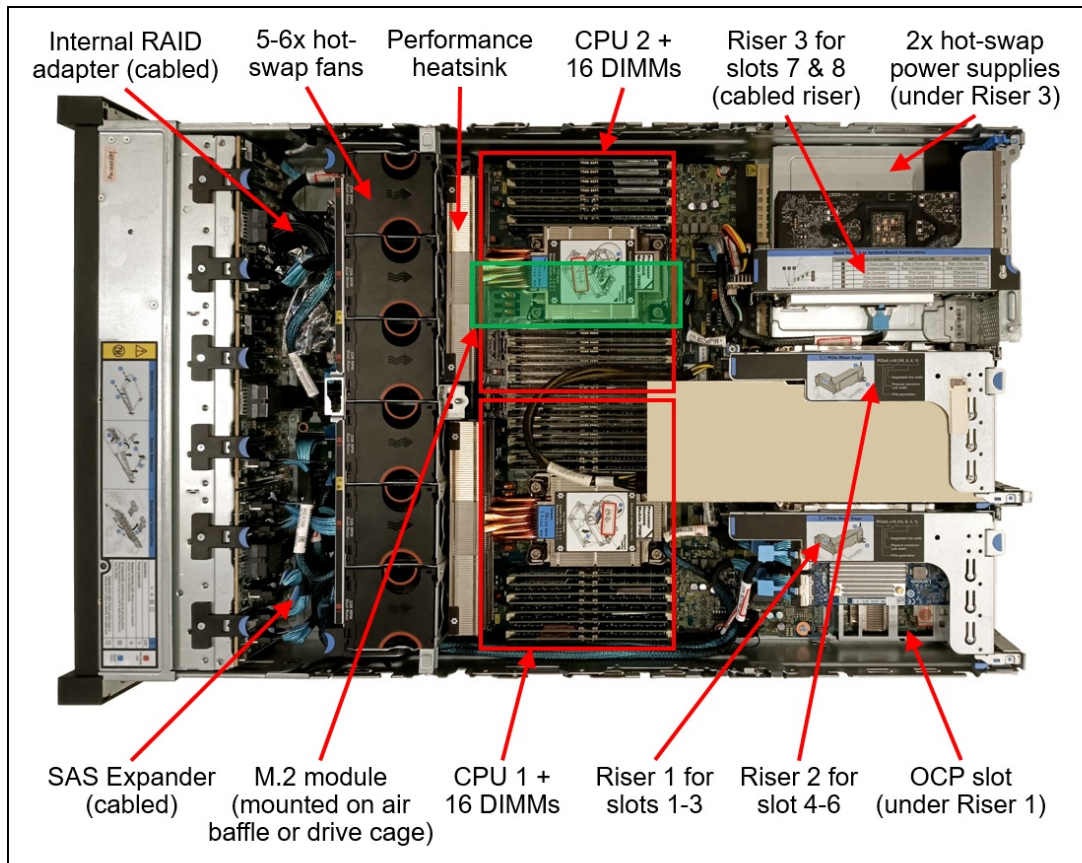

Figure 5. Internal view of the ThinkSystem SR650 V3

System architecture

The following figure shows the architectural block diagram of the SR650 V3, showing the major components and their connections.

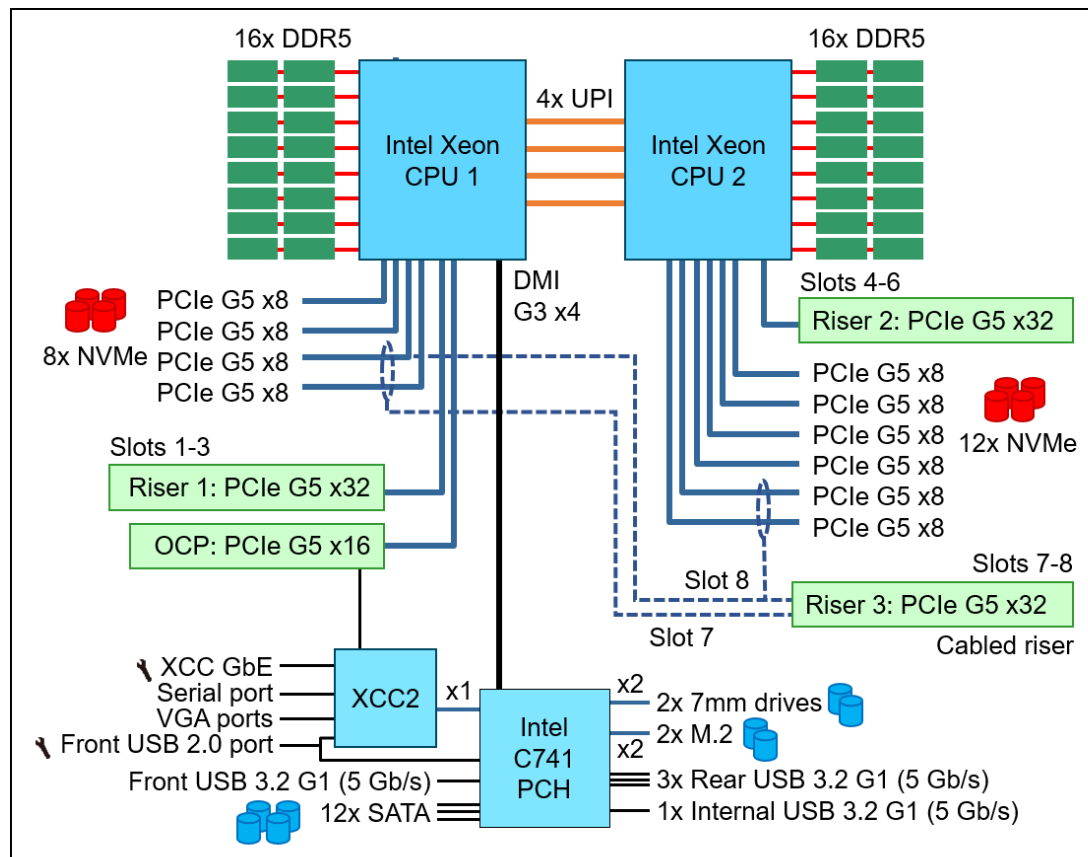

Figure 6. SR650 V3 system architectural block diagram

Standard specifications

The following table lists the standard specifications.

Table 2. Standard specifications

Components	Specification
Machine types	7D75 - 1 year warranty 7D76 - 3 year warranty
Form factor	2U rack
Processor	One or two 5th Gen Intel Xeon Scalable processors (formerly codenamed "Emerald Rapids"), or one or two 4th Gen Intel Xeon Scalable processors (formerly codenamed "Sapphire Rapids"). Supports processors up to 64 cores, core speeds of up to 3.9 GHz, and TDP ratings of up to 385 W.
Chipset	Intel C741 "Emmitsburg" chipset, part of the platform codenamed "Eagle Stream"
Memory	32 DIMM slots with two processors (16 DIMM slots per processor). Each processor has 8 memory channels, with 2 DIMMs per channel (DPC). Lenovo TruDDR5 RDIMMs, 9x4 RDIMMs, and 3DS RDIMMs are supported. DIMMs operate at up to 5600 MHz at 1 DPC and up to 4800 MHz at 2 DPC.
Persistent memory	No support.

Components	Specification
Memory maximum	Up to 8TB by using 32x 256GB 3DS RDIMMs
Memory protection	ECC, SDDC (for x4-based memory DIMMs), ADDDC (for x4-based memory DIMMs excluding 9x4 RDIMMs, requires Platinum or Gold processors), and memory mirroring.
Disk drive bays	<p>Up to 20x 3.5-inch or 40x 2.5-inch hot-swap drive bays:</p> <ul style="list-style-type: none"> ● Front bays can be 3.5-inch (8 or 12 bays) or 2.5-inch (8, 16 or 24 bays) ● Middle bays can be 3.5-inch (4 bays) or 2.5-inch (8 bays) ● Rear bays can be 3.5-inch (2 or 4 bays) or 2.5-inch (4 or 8 bays) ● Combinations of SAS/SATA, NVMe, or AnyBay (supporting SAS, SATA or NVMe) are available <p>The server also supports these drives for OS boot or drive storage:</p> <ul style="list-style-type: none"> ● Two 7mm drives at the rear of the server (in addition to any 2.5-inch or 3.5-inch drive bays) ● Internal M.2 module supporting up to two M.2 drives <p>See Supported drive bay combinations for details.</p>
Maximum internal storage	<ul style="list-style-type: none"> ● 2.5-inch drives: <ul style="list-style-type: none"> ○ 1228.8TB using 40x 30.72TB 2.5-inch SAS/SATA SSDs ○ 1966.08TB using 32x 61.44TB 2.5-inch NVMe SSDs ○ 96TB using 40x 2.4TB 2.5-inch HDDs ○ 15.36TB using 2x 7.68TB 7mm SSDs ● 3.5-inch drives: <ul style="list-style-type: none"> ○ 480TB using 20x 24TB 3.5-inch HDDs ○ 307.2TB using 20x 15.36TB 3.5-inch SAS/SATA SSDs ○ 153.6TB using 12x 12.8TB 3.5-inch NVMe SSDs
Storage controller	<ul style="list-style-type: none"> ● 14x Onboard SATA ports (Intel VROC SATA RAID, formerly known as Intel RSTe RAID) ● Up to 20x Onboard NVMe ports (includes Intel VROC NVMe RAID, with optional license for non-Intel NVMe SSDs) ● NVMe Retimer Adapter (supports Intel VROC NVMe RAID) ● 12 Gb SAS/SATA RAID adapters <ul style="list-style-type: none"> ○ 8, 16 or 32 ports ○ Up to 8GB flash-backed cache ○ PCIe 4.0 or PCIe 3.0 host interface ● 12 Gb SAS/SATA HBA (non-RAID) <ul style="list-style-type: none"> ○ 8-port and 16-port ○ PCIe 4.0 or PCIe 3.0 host interface
Optical drive bays	No internal optical drive
Tape drive bays	No internal backup drive
Network interfaces	Dedicated OCP 3.0 SFF slot with PCIe 5.0 x16 host interface. Supports a variety of 2-port and 4-port adapters with 1, 10, 25 or 100 GbE network connectivity. One port can optionally be shared with the XClarity Controller 2 (XCC2) management processor for Wake-on-LAN and NC-SI support.

Components	Specification
PCIe slots	<p>Up to 12x PCIe slots (10x rear, 2x front), plus a slot dedicated to an OCP 3.0 adapter. 2.5-inch drive configurations also support an additional internal bay for a cabled RAID adapter or HBA.</p> <p><i>Rear:</i> Up to 10x PCIe slots, plus a slot dedicated to the OCP adapter. Slot are either PCIe 5.0 or 4.0 depending on riser selection and rear drive bay selection. The use of some slots requires two processors.</p> <p>Slots are configured using three riser cards. Riser 1 (slots 1-3) and Riser 2 (slots 4-6) are installed in slots in the system board, Riser 3 (slots 7-8) and Riser 4 (9-10) are cabled to ports on the system board. A variety of riser cards are available. See the I/O expansion for details.</p> <p><i>Front:</i> The server also supports slots at the front of the server (configurations with up to 16 drive bays): 2x PCIe x16 full-height half-length slots, plus 1x OCP 3.0 slot</p> <p><i>Internal:</i> For 2.5-inch front drive configurations, the server supports the installation of a RAID adapter or HBA in a dedicated area that does not consume any of the PCIe slots.</p>
GPU support	Supports up to 8x single-wide GPUs or up to 3x double-wide GPUs
Ports	<p>Front: 1x USB 3.2 G1 (5 Gb/s) port, 1x USB 2.0 port (also for XCC local management), External diagnostics port, optional VGA port.</p> <p>Rear: 3x USB 3.2 G1 (5 Gb/s) ports, 1x VGA video port, 1x RJ-45 1GbE systems management port for XCC remote management. Optional DB-9 COM serial port (installs in slot 3).</p> <p>Internal: 1x USB 3.2 G1 (5 Gb/s) connector for operating system or license key purposes</p>
Cooling	6x (with two processors installed) or 5x (with one processor installed) single-rotor or dual-rotor hot swap 60 mm fans, configuration dependent. Fans are N+1 redundant, tolerating a single-rotor failure. One fan integrated in each power supply. For customers with water infrastructure in their data center, the SR650 V3 also supports open-loop water cooling for efficient heat removal.
Power supply	Up to two hot-swap redundant AC power supplies, 80 PLUS Platinum or 80 PLUS Titanium certification. 750 W, 1100 W, 1800 W, 2400 W and 2600W AC options, supporting 220 V AC. 750 W and 1100 W options also support 110V input supply. In China only, all power supply options support 240 V DC. Also available is a 1100W power supply with a -48V DC input.
Video	Embedded graphics with 16 MB memory with 2D hardware accelerator, integrated into the XClarity Controller 2 management controller. Maximum resolution is 1920x1200 32bpp at 60Hz.
Hot-swap parts	Drives, power supplies, and fans.
Systems management	Operator panel with status LEDs. Optional External Diagnostics Handset with LCD display. Models with 8x or 16x 2.5-inch front drive bays can optionally support an Integrated Diagnostics Panel. XClarity Controller 2 (XCC2) embedded management controller, XClarity Administrator centralized infrastructure delivery, XClarity Integrator plugins, and XClarity Energy Manager centralized server power management. Optional XClarity Controller Platinum to enable remote control and other functions.
Security features	Chassis intrusion switch, Power-on password, administrator's password, Root of Trust module supporting TPM 2.0 and Platform Firmware Resiliency (PFR). Optional lockable front security bezel.
Operating systems supported	Microsoft Windows Server, Microsoft Windows 10 & 11, Red Hat Enterprise Linux, SUSE Linux Enterprise Server, VMware ESXi, Ubuntu Server. See the Operating system support section for specifics.
Limited warranty	Three-year or one-year (model dependent) customer-replaceable unit and onsite limited warranty with 9x5 next business day (NBD).
Service and support	Optional service upgrades are available through Lenovo Services: 4-hour or 2-hour response time, 6-hour fix time, 1-year or 2-year warranty extension, software support for Lenovo hardware and some third-party applications.
Dimensions	Width: 445 mm (17.5 in.), height: 87 mm (3.4 in.), depth: 766 mm (30.1 in.). See Physical and electrical specifications for details.

Components	Specification
Weight	Maximum: 38.8 kg (85.5 lb)

Models

ThinkSystem SR650 V3 models can be configured by using the [Lenovo Data Center Solution Configurator \(DCSC\)](#).

Topics in this section:

- [CTO models](#)
- [CTO models for Windows 10 and Windows 11](#)
- [CTO models for NVIDIA Bluefield SmartNIC DPUs](#)
- [Base feature codes](#)
- [Preconfigured models](#)

CTO models

ThinkSystem SR650 V3 models can be configured by using the [Lenovo Data Center Solution Configurator \(DCSC\)](#).

Configure-to-order (CTO) models are used to create models with factory-integrated server customizations. For CTO models, two types of base CTO models are available for the SR650 V3 as listed in the columns in the following table:

- General purpose base CTO models are for general business (non-HPC) and is selectable by choosing **General Purpose** mode in DCSC.
- AI and HPC base models are intended for Artificial Intelligence (AI) and High Performance Computing (HPC) configurations and solutions are enabled using the **AI & HPC Hardware - ThinkSystem Hardware** mode in DCSC. These configurations, along with Lenovo EveryScale Solutions, can also be built using [System x and Cluster Solutions Configurator \(x-config\)](#). **Tip:** Some HPC and AI models are not listed in DCSC and can only be configured in x-config.

Controlled GPU models: The "Controlled GPU" base CTO models listed in the table are the only models that support high-performance GPUs and accelerators. These models are classified under US Government ECCN regulations and have limited market and customer availability. All other base models do not support high-performance GPUs.

Preconfigured server models may also be available for the SR650 V3, however these are region-specific; that is, each region may define their own server models, and not all server models are available in every region.

The following table lists the base CTO models of the ThinkSystem SR650 V3 server.

Table 3. Base CTO models

Machine Type/Model General purpose	Machine Type/Model for AI and HPC	Description
7D76CTO1WW	7D76CTOLWW	ThinkSystem SR650 V3 - 3yr warranty
7D76CTOEWW	7D76CTOPWW	ThinkSystem SR650 V3 - 3yr warranty with Controlled GPU
7D75CTO1WW	7D75CTOLWW	ThinkSystem SR650 V3 - 1yr warranty
7D77CTO1WW	7D77CTOLWW	ThinkSystem SR650 V3 – SAP HANA configurations with 3-year warranty

CTO models for Windows 10 and Windows 11

The SR650 V3 can run Windows 10 and Windows 11, however only a subset of adapters and drives can be installed. For ease of configuration, the following Base CTO models have been announced to assist building a configuration that can be used with the client operating systems. For more information, see the [Windows 10 and Windows 11](#) section.

Table 4. Base CTO models for SR650 V3 with Windows 10 and Windows 11

Machine Type/Model	Description
7D76CTO3WW	ThinkSystem SR650 V3 Workstation - 3 year Warranty
7D76CTOFWW	ThinkSystem SR650 V3 Workstation - 3 year Warranty with Controlled GPU
7D75CTO3WW	ThinkSystem SR650 V3 Workstation - 1 year Warranty

CTO models for NVIDIA Bluefield SmartNIC DPUs

The SR650 V3 supports the new VMware vSphere Distributed Services Engine (DSE) using the NVIDIA Bluefield SmartNIC Data Processing Unit (DPU). This solution improves the performance of VMware vSphere by offloading tasks from server CPUs to the DPU thereby making data center applications more efficient.

VMware vSphere Distributed Services Engine is only available in CTO builds using the DPU-specific models listed in the following table.

For more information, see the [DPU adapter](#) section.

Table 5. Base CTO models for SR650 V3 with NVIDIA Bluefield SmartNIC DPU support

Machine Type/Model	Description
7D76CTO4WW and 7D76CTOGWW	ThinkSystem SR650 V3 DPU - 3 year Warranty
7D75CTO4WW	ThinkSystem SR650 V3 DPU - 1 year Warranty

Base feature codes

Models of the SR650 V3 are defined based on whether the server has 2.5-inch drive bays at the front (called the 2.5-inch chassis) or whether it has 3.5-inch drive bays at the front (called the 3.5-inch chassis). For models, the feature codes for these chassis bases are as listed in the following table.

Table 6. Chassis base feature codes

Feature code	Description
BLKK	ThinkSystem SR650 V3 24x2.5" Chassis
BLKJ	ThinkSystem SR650 V3 12x3.5" Chassis

Preconfigured models

The following tables list the available preconfigured models, grouped by region.

- [Models for Asia Pacific region](#)
- [Models for Australia and New Zealand](#)
- [Models for Brazil](#)
- [Models for China](#)
- [Models for EMEA region](#)
- [Models for India](#)
- [Models for Latin American countries \(except Brazil\)](#)
- [Models for USA and Canada](#)

Refer to the Specifications section for information about standard features of the server.

Common to all models:

- Power supplies are Platinum unless otherwise stated
- All models include a Toolless Slide Rail Kit

Models for Asia Pacific region

The following table lists the models for the Asia Pacific region: Australia, Bangladesh, Brunei, Hong Kong, India, Japan, Korea, Sri Lanka, Malaysia, New Zealand, Philippines, Singapore, Thailand, Taiwan, Vietnam

Table 7. Models for Asia Pacific markets

Model	Intel Xeon Scalable processor†	Memory	RAID	Drive bays	OCP	Slots	Power supply	Fans	Front VGA	Front diag	XCC2	Intru switch
Standard models with a 3-year warranty (machine type 7D76)												
Models with 5th Gen Intel Xeon Scalable processors												
7D76A06SAP	1x Silver 4509Y 8C 125W 2.6G	1x16GB	9350-8i	8x 2.5" SAS Open bay	4x1G 5719	3(x16, x8, x8)Gen4	1x750W	5x Std	Yes	Yes	Std	Opt
7D76A06RAP	1x Silver 4510 12C 150W 2.4G	1x16GB	9350-8i	8x 2.5" SAS Open bay	4x1G 5719	3(x16, x8, x8)Gen4	1x750W	5x Std	Yes	Yes	Std	Opt
7D76A06QAP	1x Silver 4514Y 16C 150W 2.0G	1x16GB 1Rx8	9350-8i	8x 2.5" SAS Open bay	4x1G 5719	3(x16, x8, x8)Gen4	1x750W	5x Std	Yes	Yes	Std	Opt
Models with 4th Gen Intel Xeon Scalable processors												
7D76A01UAP	1x Silver 4410T 10C 150W 2.7G	1x16GB	9350-16i	12x 3.5" SAS Open bay	Open	3(x16, x8, x8)Gen4	1x750W	5x Std	Yes	Yes	Std	Opt
7D76A01XAP	1x Silver 4410T 10C 150W 2.7G	1x16GB	9350-8i	8x 2.5" SAS Open bay	Open	3(x16, x8, x8)Gen4	1x750W	5x Std	Yes	Yes	Std	Opt
7D76A021AP	1x Silver 4410Y 12C 150W 2.0G	1x16GB	9350-8i	8x 2.5" SAS Open bay	Open	3(x16, x8, x8)Gen4	1x750W	5x Std	Yes	Yes	Std	Opt
7D76A02JAP	1x Silver 4410Y 12C 150W 2.0G	1x16GB	9350-16i	12x 3.5" SAS Open bay	Open	3(x16, x8, x8)Gen4	1x750W	5x Std	Yes	Yes	Std	Opt
7D76A01TAP	1x Gold 5415+ 8C 150W 2.9G	1x16GB	9350-16i	12x 3.5" SAS Open bay	Open	3(x16, x8, x8)Gen4	1x750W	5x Std	Yes	Yes	Std	Opt
7D76A01WAP	1x Gold 5415+ 8C 150W 2.9G	1x16GB	9350-8i	8x 2.5" SAS Open bay	Open	3(x16, x8, x8)Gen4	1x750W	5x Std	Yes	Yes	Std	Opt

† Processor description: Processor model, number of cores, thermal design power (TDP), core frequency

Models for Australia and New Zealand

AP models: Customers in Australia and New Zealand also have access to the [Asia Pacific region](#) models.

Common to all Australia and New Zealand models:

- All models include a Toolless Slide Rail Kit and Cable Management Arm

Table 8. Models for Australia and New Zealand

Model	Intel Xeon Scalable processor†	Memory	RAID	Drive bays	OCP	Slots	Power supply	Fans	Front VGA	Front diag	XCC2	Intru switch
TopSeller models with a 3-year warranty (machine type 7D76)												
Models with 5th Gen Intel Xeon Scalable processors												
7D76A05QAU	1x Silver 4509Y 8C 125W 2.6G	1x32GB 2Rx8	9350-8i	8x 2.5" SAS Open bay	Open	3 (x16, x8, x8) Gen4	1x750W	5x Perf	Yes	Yes	Std	Opt
7D76A064AU	1x Silver 4509Y 8C 125W 2.6G	1x16GB	5350-8i	8x 2.5" SAS Open bay	Open	3 (x16, x8, x8) Gen4	1x750W	5x Perf	Yes	Yes	Std	Opt
7D76A06JAU	1x Silver 4509Y 8C 125W 2.6G	1x16GB	9350-16i	12x 3.5" SAS Open bay	Open	3 (x16, x8, x8) Gen4	1x750W	5x Perf	Yes	Yes	Std	Opt
7D76A05NAU	1x Silver 4510 12C 150W 2.4G	1x32GB 2Rx8	9350-8i	8x 2.5" SAS Open bay	Open	3 (x16, x8, x8) Gen4	1x750W	5x Perf	Yes	Yes	Std	Opt
7D76A05RAU	1x Silver 4514Y 16C 150W 2.0G	1x32GB 2Rx8	9350-8i	8x 2.5" SAS Open bay	Open	3 (x16, x8, x8) Gen4	1x750W	5x Perf	Yes	Yes	Std	Opt
7D76A062AU	1x Silver 4514Y 16C 150W 2.0G	1x32GB 2Rx8	Option	16x 2.5" Any Open bay	Open	3 (x16, x8, x8) Gen4	1x750W	5x Perf	Yes	Yes	Std	Opt
Models with 4th Gen Intel Xeon Scalable processors												
7D76A01VAU	1x Silver 4410Y 12C 150W 2.0G	1x16GB	9350-16i	12x 3.5" SAS Open bay	Open	3 (x16, x8, x8) Gen4	1x750W	5x Perf	Yes	Yes	Std	Opt
7D76A029AU	1x Silver 4410Y 12C 150W 2.0G	1x16GB	5350-8i	8x 2.5" SAS Open bay	Open	3 (x16, x8, x8) Gen4	1x750W	5x Perf	Yes	Yes	Std	Opt
7D76A02EAU	1x Silver 4410Y 12C 150W 2.0G	1x32GB 2Rx8	9350-8i	8x 2.5" SAS Open bay	Open	3 (x16, x8, x8) Gen4	1x750W	5x Perf	Yes	Yes	Std	Opt
7D76A02GAU	1x Gold 5416S 16C 150W 2.0G	1x32GB 2Rx8	9350-8i	8x 2.5" SAS Open bay	Open	3 (x16, x8, x8) Gen4	1x750W	5x Perf	Yes	Yes	Std	Opt
7D76A022AU	1x Gold 5418Y 24C 185W 2.0G	1x32GB 2Rx8	9350-8i	8x 2.5" SAS Open bay	Open	3 (x16, x8, x8) Gen4	1x750W	5x Perf	Yes	Yes	Std	Opt
7D76A02SAU	1x Gold 5418Y 24C 185W 2.0G	1x32GB 2Rx8	Option	16x 2.5" Any Open bay	Open	3 (x16, x8, x8) Gen5	1x750W	5x Perf	Yes	Yes	Std	Opt

† Processor description: Processor model, number of cores, thermal design power (TDP), core frequency

Models for Brazil

Table 9. Models for Brazil

Model	Intel Xeon Scalable processor†	Memory	RAID	Drive bays	OCP	Slots	Power supply	Fans	Front VGA	Front diag	XCC2	Intru switch
TopSeller models with a 3-year warranty (machine type 7D76)												
7D76A08ZBR	1x Bronze 3408U 8C 125W 1.8G	1x32GB 1Rx4	9350-8i	8x 3.5" SAS Open bay	4x1G 5719	3 (x16, x8, x8) Gen5	2x 1100W	5x Perf	Opt	Opt	Plat	Opt

Model	Intel Xeon Scalable processor†	Memory	RAID	Drive bays	OCP	Slots	Power supply	Fans	Front VGA	Front diag	XCC2	Intru switch
7D76A091BR	1x Bronze 3408U 8C 125W 1.8G	1x32GB 1Rx4	9350-8i	8x 2.5" SAS Open bay	4x1G 5719	3 (x16, x8, x8) Gen5	2x 1100W	5x Perf	Opt	Opt	Plat	Opt
7D76A03TBR	2x Silver 4410T 10C 150W 2.7G	2x32GB 1Rx4	9350-8i	8x 3.5" SAS; 2x 480GB S4520	4x1G 5719	3 (x16, x8, x8) Gen5	2x 1100W	6x Perf	Opt	Opt	Std	Opt
7D76A03VBR	1x Silver 4410T 10C 150W 2.7G	1x32GB 1Rx4	9350-8i	8x 3.5" SAS; 2x 480GB S4520	4x1G 5719	3 (x16, x8, x8) Gen5	2x 1100W	5x Perf	Opt	Opt	Std	Opt
7D76A03YBR	1x Silver 4410T 10C 150W 2.7G	1x32GB 1Rx4	9350-8i	8x 3.5" SAS; 2x 480GB S4520	4x1G 5719	3 (x16, x8, x8) Gen5	2x 1100W	5x Perf	Opt	Opt	Std	Opt
7D76A03ZBR	1x Silver 4410T 10C 150W 2.7G	2x32GB 1Rx4	9350-8i	8x 3.5" SAS; 2x 480GB S4520	4x1G 5719	3 (x16, x8, x8) Gen5	2x 1100W	5x Perf	Opt	Opt	Std	Opt
7D76A06NBR	1x Silver 4410T 10C 150W 2.7G	2x32GB 1Rx4	9350-8i	8x 3.5" SAS; 1x 2TB SAS HDD	4x1G 5719	3 (x16, x8, x8) Gen5	2x 1100W	5x Perf	Opt	Opt	Std	Opt
7D76A06PBR	1x Silver 4410T 10C 150W 2.7G	2x32GB 1Rx4	9350-8i	8x 3.5" SAS; 2x 2TB SAS HDD	4x1G 5719	3 (x16, x8, x8) Gen5	2x 1100W	5x Perf	Opt	Opt	Std	Opt
7D76A07GBR	1x Silver 4410T 10C 150W 2.7G	1x32GB 1Rx4	9350-8i	8x 3.5" SAS Open bay 1x M.2 SATA/x4NVMe	4x1G 5719	3 (x16, x8, x8) Gen5	2x 1100W	5x Perf	Opt	Opt	Std	Opt
7D76A041BR	2x Silver 4410Y 12C 150W 2.0G	2x32GB 1Rx4	9350-8i	8x 3.5" SAS; 2x 480GB S4520	4x1G 5719	3 (x16, x8, x8) Gen5	2x 1100W	6x Perf	Opt	Opt	Std	Opt
7D76A042BR	1x Silver 4410Y 12C 150W 2.0G	1x32GB 1Rx4	9350-8i	8x 3.5" SAS; 2x 480GB S4520	4x1G 5719	3 (x16, x8, x8) Gen5	2x 750W	5x Perf	Opt	Opt	Std	Opt
7D76A06MBR	2x Silver 4410Y 12C 150W 2.0G	2x32GB 1Rx4	9350-8i	8x 3.5" SAS; 1x 2TB SAS HDD	4x1G 5719	3 (x16, x8, x8) Gen5	2x 1100W	6x Perf	Opt	Opt	Std	Opt
7D76A07ZBR	1x Silver 4410Y 12C 150W 2.0G	1x32GB 1Rx4	9350-8i	8x 2.5" SAS Open bay 1x M.2 SATA/x4NVMe, 2x 480GB ER3 M.2	4x1G 5719	3 (x16, x8, x8) Gen4	1x750W	5x Perf	Opt	Opt	Std	Opt
7D76A082BR	1x Silver 4410Y 12C 150W 2.0G	1x32GB 1Rx4	9350-8i	8x 3.5" SAS Open bay 1x M.2 SATA/x4NVMe, 2x 480GB ER3 M.2	4x1G 5719	3 (x16, x8, x8) Gen5	2x 1100W	5x Perf	Opt	Opt	Std	Opt
7D76A090BR	1x Silver 4410Y 12C 150W 2.0G	1x32GB 1Rx4	9350-8i	8x 2.5" SAS Open bay	4x1G 5719	3 (x16, x8, x8) Gen5	2x750W	5x Perf	Opt	Opt	Plat	Opt
7D76A092BR	1x Silver 4410Y 12C 150W 2.0G	1x32GB 1Rx4	9350-8i	8x 3.5" SAS Open bay	4x1G 5719	3 (x16, x8, x8) Gen5	2x 1100W	5x Perf	Opt	Opt	Plat	Opt
7D76A07YBR	1x Gold 5416S 16C 150W 2.0G	1x32GB 1Rx4	9350-8i	8x 3.5" SAS Open bay	4x1G 5719	3 (x16, x8, x8) Gen5	1x750W	5x Perf	Opt	Opt	Std	Opt

Model	Intel Xeon Scalable processor†	Memory	RAID	Drive bays	OCP	Slots	Power supply	Fans	Front VGA	Front diag	XCC2	Intru switch
7D76A080BR	1x Gold 5416S 16C 150W 2.0G	1x32GB 1Rx4	9350-8i	8x 2.5" SAS Open bay	4x1G 5719	3 (x16, x8, x8) Gen5	1x750W	5x Perf	Opt	Opt	Std	Opt
7D76A081BR	1x Gold 5416S 16C 150W 2.0G	1x32GB 1Rx4	9350-8i	8x 3.5" SAS Open bay	4x1G 5719	3 (x16, x8, x8) Gen5	1x750W	5x Perf	Opt	Opt	Plat	Opt
7D76A083BR	1x Gold 5416S 16C 150W 2.0G	1x32GB 1Rx4	9350-8i	8x 3.5" SAS Open bay 1x M.2 SATA/x4NVMe, 2x 480GB ER3 M.2	2x10GT 57416	3 (x16, x8, x8) Gen4	1x1100W	5x Perf	Opt	Opt	Plat	Yes

† Processor description: Processor model, number of cores, thermal design power (TDP), core frequency

Models for China

Table 10. Models for China

Model	Intel Xeon Scalable processor†	Memory	RAID	Drive bays	OCP	Slots	Power supply	Fans	Front VGA	Front diag	XCC2	Intru switch
Standard models with a 3-year warranty (machine type 7D76)												
7D761001CN	2x Silver 4410Y 12C 150W 2.0G	4x64GB 9x4	9350-8i	8x 2.5" Any; 2x 960GB 7450 PRO	2x25G CX6 Lx	2x x16 Gen5	2x 1100W Titanium	6x Perf	Opt	Opt	Std	Opt
7D761000CN	2x Gold 5418Y 24C 185W 2.0G	4x64GB 9x4	9350-8i	12x3.5" (8xSS, 4xNVMe); 2x 1.92TB P5520	2x25G CX6 Lx	2x x16 Gen5	2x 1100W Titanium	6x Perf	Opt	Opt	Std	Opt

† Processor description: Processor model, number of cores, thermal design power (TDP), core frequency

Models for EMEA region

Table 11. Models for EMEA region

Model	Intel Xeon Scalable processor†	Memory	RAID	Drive bays	OCP	Slots	Power supply	Fans	Front VGA	Front diag	XCC2	Intru switch
Standard models with a 3-year warranty (machine type 7D76)												
Models with 5th Gen Intel Xeon Scalable processors												
7D76A05CEA	1x Silver 4509Y 8C 125W 2.6G	1x64GB	9350-8i	8x 2.5" SAS Open bay	Open	3 (x16, x8, x8) Gen4	1x1100W Titanium	5x Std	Opt	Opt	Plat	Yes
7D76A05EEA	1x Silver 4509Y 8C 125W 2.6G	1x64GB	940-8i 4GB	8x 2.5" SAS Open bay	Open	3 (x16, x8, x8) Gen4	1x1100W Titanium	5x Std	Opt	Opt	Plat	Yes
7D76A05FEA	1x Silver 4509Y 8C 125W 2.6G	1x32GB 1Rx4	Option	Option 2.5" Open bay	Open	Open	1x1100W Titanium	5x Std	Opt	Opt	Plat	Yes
7D76A05TEA	1x Silver 4509Y 8C 125W 2.6G	1x32GB 1Rx4	940-8i 4GB	8x 2.5" SAS Open bay	Open	3 (x16, x8, x8) Gen4	1x1100W Titanium	5x Std	Opt	Opt	Plat	Yes
7D76A05VEA	1x Silver 4509Y 8C 125W 2.6G	1x32GB 1Rx4	9350-8i	8x 2.5" SAS Open bay	Open	3 (x16, x8, x8) Gen4	1x1100W Titanium	5x Std	Opt	Opt	Plat	Yes

Model	Intel Xeon Scalable processor†	Memory	RAID	Drive bays	OCP	Slots	Power supply	Fans	Front VGA	Front diag	XCC2	Intru switch
7D76A06EEA	1x Silver 4509Y 8C 125W 2.6G	1x64GB	Option	Option 2.5" Open bay	Open	Open	1x1100W Titanium	5x Std	Opt	Opt	Plat	Yes
7D76A087EA	1x Silver 4509Y 8C 125W 2.6G	1x64GB	SATA	12x 3.5" SAS Open bay	Open	Open	1x1100W Titanium	5x Perf	Opt	Yes	Plat	Yes
7D76A08LEA	1x Silver 4509Y 8C 125W 2.6G	1x32GB 1Rx4	940-16i	12x 3.5" SAS Open bay	Open	3 (x16, x8, x8) Gen4	1x1100W Titanium	5x Perf	Opt	Yes	Plat	Yes
7D76A08QEA	1x Silver 4509Y 8C 125W 2.6G	1x32GB 1Rx4	9350-16i	12x 3.5" SAS Open bay	Open	3 (x16, x8, x8) Gen4	1x1100W Titanium	5x Perf	Opt	Yes	Plat	Yes
7D76A08SEA	1x Silver 4509Y 8C 125W 2.6G	1x32GB 1Rx4	940-8i 4GB	8x 3.5" SAS Open bay	Open	3 (x16, x8, x8) Gen4	1x1100W Titanium	5x Std	Opt	Yes	Plat	Yes
7D76A08VEA	1x Silver 4509Y 8C 125W 2.6G	1x32GB 1Rx4	9350-8i	8x 3.5" SAS Open bay	Open	3 (x16, x8, x8) Gen4	1x1100W Titanium	5x Std	Opt	Yes	Plat	Yes
7D76A058EA	1x Silver 4510 12C 150W 2.4G	1x32GB 1Rx4	940-8i 4GB	8x 2.5" SAS Open bay	Open	3 (x16, x8, x8) Gen4	1x1100W Titanium	5x Std	Opt	Opt	Plat	Yes
7D76A05JEA	1x Silver 4510 12C 150W 2.4G	1x64GB	940-8i 4GB	8x 2.5" SAS Open bay	Open	3 (x16, x8, x8) Gen4	1x1100W Titanium	5x Std	Opt	Opt	Plat	Yes
7D76A05KEA	1x Silver 4510 12C 150W 2.4G	1x32GB 1Rx4	Option	Option 2.5" Open bay	Open	Open	1x1100W Titanium	5x Std	Opt	Opt	Plat	Yes
7D76A065EA	1x Silver 4510 12C 150W 2.4G	1x32GB 1Rx4	9350-8i	8x 2.5" SAS Open bay	Open	3 (x16, x8, x8) Gen4	1x1100W Titanium	5x Std	Opt	Opt	Plat	Yes
7D76A06FEA	1x Silver 4510 12C 150W 2.4G	1x64GB	9350-8i	8x 2.5" SAS Open bay	Open	3 (x16, x8, x8) Gen4	1x1100W Titanium	5x Std	Opt	Opt	Plat	Yes
7D76A06GEA	1x Silver 4510 12C 150W 2.4G	1x64GB	Option	Option 2.5" Open bay	Open	Open	1x1100W Titanium	5x Std	Opt	Opt	Plat	Yes
7D76A088EA	1x Silver 4510 12C 150W 2.4G	1x64GB	SATA	12x 3.5" SAS Open bay	Open	Open	1x1100W Titanium	5x Perf	Opt	Yes	Plat	Yes
7D76A08KEA	1x Silver 4510 12C 150W 2.4G	1x32GB 1Rx4	9350-16i	12x 3.5" SAS Open bay	Open	3 (x16, x8, x8) Gen4	1x1100W Titanium	5x Perf	Opt	Yes	Plat	Yes
7D76A08MEA	1x Silver 4510 12C 150W 2.4G	1x32GB 1Rx4	940-16i	12x 3.5" SAS Open bay	Open	3 (x16, x8, x8) Gen4	1x1100W Titanium	5x Perf	Opt	Yes	Plat	Yes
7D76A08TEA	1x Silver 4510 12C 150W 2.4G	1x32GB 1Rx4	940-8i 4GB	8x 3.5" SAS Open bay	Open	3 (x16, x8, x8) Gen4	1x1100W Titanium	5x Std	Opt	Yes	Plat	Yes
7D76A08WEA	1x Silver 4510 12C 150W 2.4G	1x32GB 1Rx4	9350-8i	8x 3.5" SAS Open bay	Open	3 (x16, x8, x8) Gen4	1x1100W Titanium	5x Std	Opt	Yes	Plat	Yes
7D76A05DEA	1x Silver 4514Y 16C 150W 2.0G	1x64GB 2Rx4	940-8i 4GB	8x 2.5" SAS Open bay	Open	3 (x16, x8, x8) Gen4	1x1100W Titanium	5x Std	Opt	Opt	Plat	Yes
7D76A05MEA	1x Silver 4514Y 16C 150W 2.0G	1x32GB 1Rx4	940-8i 4GB	8x 2.5" SAS Open bay	Open	3 (x16, x8, x8) Gen4	1x1100W Titanium	5x Std	Opt	Opt	Plat	Yes
7D76A05ZEA	1x Silver 4514Y 16C 150W 2.0G	1x32GB 1Rx4	9350-8i	8x 2.5" SAS Open bay	Open	3 (x16, x8, x8) Gen4	1x1100W Titanium	5x Std	Opt	Opt	Plat	Yes
7D76A063EA	1x Silver 4514Y 16C 150W 2.0G	1x32GB 1Rx4	Option	Option 2.5" Open bay	Open	Open	1x1100W Titanium	5x Std	Opt	Opt	Plat	Yes
7D76A06AEA	1x Silver 4514Y 16C 150W 2.0G	1x64GB 2Rx4	Option	Option 2.5" Open bay	Open	Open	1x1100W Titanium	5x Std	Opt	Opt	Plat	Yes
7D76A06HEA	1x Silver 4514Y 16C 150W 2.0G	1x64GB 2Rx4	9350-8i	8x 2.5" SAS Open bay	Open	3 (x16, x8, x8) Gen4	1x1100W Titanium	5x Std	Opt	Opt	Plat	Yes
7D76A08NEA	1x Silver 4514Y 16C 150W 2.0G	1x32GB 1Rx4	940-16i	12x 3.5" SAS Open bay	Open	3 (x16, x8, x8) Gen4	1x1100W Titanium	5x Perf	Opt	Yes	Plat	Yes
7D76A08PEA	1x Silver 4514Y 16C 150W 2.0G	1x32GB 1Rx4	9350-16i	12x 3.5" SAS Open bay	Open	3 (x16, x8, x8) Gen4	1x1100W Titanium	5x Perf	Opt	Yes	Plat	Yes
7D76A08UEA	1x Silver 4514Y 16C 150W 2.0G	1x32GB 1Rx4	940-8i 4GB	8x 3.5" SAS Open bay	Open	3 (x16, x8, x8) Gen4	1x1100W Titanium	5x Std	Opt	Yes	Plat	Yes

Model	Intel Xeon Scalable processor†	Memory	RAID	Drive bays	OCP	Slots	Power supply	Fans	Front VGA	Front diag	XCC2	Intru switch
7D76A08XEA	1x Silver 4514Y 16C 150W 2.0G	1x32GB 1Rx4	9350-8i	8x 3.5" SAS Open bay	Open	3 (x16, x8, x8) Gen4	1x1100W Titanium	5x Std	Opt	Yes	Plat	Yes
7D76A05SEA	1x Silver 4516Y+ 24C 185W 2.2G	1x32GB 1Rx4	9350-8i	8x 2.5" SAS Open bay	Open	3 (x16, x8, x8) Gen4	1x1100W Titanium	5x Std	Opt	Opt	Plat	Yes
7D76A05YEA	1x Silver 4516Y+ 24C 185W 2.2G	1x64GB 2Rx4	9350-8i	8x 2.5" SAS Open bay	Open	3 (x16, x8, x8) Gen4	1x1100W Titanium	5x Std	Opt	Opt	Plat	Yes
7D76A06BEA	1x Silver 4516Y+ 24C 185W 2.2G	1x64GB 2Rx4	Option	Option 2.5" Open bay	Open	Open	1x1100W Titanium	5x Std	Opt	Opt	Plat	Yes
7D76A05LEA	1x Gold 5515+ 8C 165W 3.2G	1x32GB 1Rx4	Option	Option 2.5" Open bay	Open	Open	1x1100W Titanium	5x Std	Opt	Opt	Plat	Yes
7D76A05UEA	1x Gold 5515+ 8C 165W 3.2G	1x32GB 1Rx4	9350-8i	8x 2.5" SAS Open bay	Open	3 (x16, x8, x8) Gen4	1x1100W Titanium	5x Std	Opt	Opt	Plat	Yes
7D76A067EA	1x Gold 5515+ 8C 165W 3.2G	1x64GB 2Rx4	9350-8i	8x 2.5" SAS Open bay	Open	3 (x16, x8, x8) Gen4	1x1100W Titanium	5x Std	Opt	Opt	Plat	Yes
7D76A068EA	1x Gold 5515+ 8C 165W 3.2G	1x64GB 2Rx4	Option	Option 2.5" Open bay	Open	Open	1x1100W Titanium	5x Std	Opt	Opt	Plat	Yes
7D76A069EA	1x Gold 5515+ 8C 165W 3.2G	1x64GB 2Rx4	940-8i 4GB	8x 2.5" SAS Open bay	Open	3 (x16, x8, x8) Gen4	1x1100W Titanium	5x Std	Opt	Opt	Plat	Yes
7D76A06DEA	1x Gold 5515+ 8C 165W 3.2G	1x32GB 1Rx4	940-8i 4GB	8x 2.5" SAS Open bay	Open	3 (x16, x8, x8) Gen4	1x1100W Titanium	5x Std	Opt	Opt	Plat	Yes
7D76A05AEA	1x Gold 6526Y 16C 195W 2.8G	1x32GB 1Rx4	Option	Option 2.5" Open bay	Open	Open	1x1100W Titanium	5x Perf	Opt	Opt	Plat	Yes
7D76A05PEA	1x Gold 6526Y 16C 195W 2.8G	1x32GB 1Rx4	9350-8i	8x 2.5" SAS Open bay	Open	3 (x16, x8, x8) Gen4	1x1100W Titanium	5x Perf	Opt	Opt	Plat	Yes
7D76A05XEA	1x Gold 6526Y 16C 195W 2.8G	1x64GB 2Rx4	9350-8i	8x 2.5" SAS Open bay	Open	3 (x16, x8, x8) Gen4	1x1100W Titanium	5x Perf	Opt	Opt	Plat	Yes
7D76A060EA	1x Gold 6526Y 16C 195W 2.8G	1x64GB 2Rx4	940-8i 4GB	8x 2.5" SAS Open bay	Open	3 (x16, x8, x8) Gen4	1x1100W Titanium	5x Perf	Opt	Opt	Plat	Yes
7D76A061EA	1x Gold 6526Y 16C 195W 2.8G	1x32GB 1Rx4	940-8i 4GB	8x 2.5" SAS Open bay	Open	3 (x16, x8, x8) Gen4	1x1100W Titanium	5x Perf	Opt	Opt	Plat	Yes
7D76A06LEA	1x Gold 6526Y 16C 195W 2.8G	1x64GB 2Rx4	Option	Option 2.5" Open bay	Open	Open	1x1100W Titanium	5x Perf	Opt	Opt	Plat	Yes
7D76A059EA	1x Gold 6530 32C 270W 2.1G	1x64GB 2Rx4	9350-8i	8x 2.5" SAS Open bay	Open	3 (x16, x8, x8) Gen4	1x1100W Titanium	5x Perf	Opt	Yes	Plat	Yes
7D76A06CEA	1x Gold 6530 32C 270W 2.1G	1x64GB 2Rx4	Option	Option 2.5" Open bay	Open	Open	1x1100W Titanium	5x Perf	Opt	Yes	Plat	Yes
7D76A06KEA	1x Gold 6530 32C 270W 2.1G	1x32GB 1Rx4	9350-8i	8x 2.5" SAS Open bay	Open	3 (x16, x8, x8) Gen4	1x1100W Titanium	5x Perf	Opt	Yes	Plat	Yes
7D76A05GEA	1x Gold 6538Y+ 32C 225W 2.2G	1x64GB 2Rx4	9350-8i	8x 2.5" SAS Open bay	Open	3 (x16, x8, x8) Gen4	1x1100W Titanium	5x Perf	Opt	Yes	Plat	Yes
7D76A05HEA	1x Gold 6538Y+ 32C 225W 2.2G	1x64GB 2Rx4	Option	Option 2.5" Open bay	Open	Open	1x1100W Titanium	5x Perf	Opt	Yes	Plat	Yes
7D76A05BEA	1x Gold 6544Y 16C 270W 3.6G	1x64GB 2Rx4	9350-8i	8x 2.5" SAS Open bay	Open	3 (x16, x8, x8) Gen4	1x1100W Titanium	5x Perf	Opt	Yes	Plat	Yes
7D76A05WEA	1x Gold 6544Y 16C 270W 3.6G	1x64GB 2Rx4	Option	Option 2.5" Open bay	Open	Open	1x1100W Titanium	5x Perf	Opt	Yes	Plat	Yes
Models with 4th Gen Intel Xeon Scalable processors												
7D76A01YEA	1x Silver 4410Y 12C 150W 2.0G	1x64GB	SATA	12x 3.5" SAS Open bay	Open	Open	1x1100W Titanium	5x Perf	Opt	Yes	Plat	Yes
7D76A023EA	1x Silver 4410Y 12C 150W 2.0G	1x64GB	9350-8i 2GB Int	8x 2.5" SAS Open bay	Open	Open	1x1100W Titanium	5x Perf	Opt	Yes	Plat	Yes

Model	Intel Xeon Scalable processor†	Memory	RAID	Drive bays	OCP	Slots	Power supply	Fans	Front VGA	Front diag	XCC2	Intru switch
7D76A02KEA	1x Silver 4410Y 12C 150W 2.0G	1x64GB	SATA	8x 3.5" SAS Open bay	Open	Open	1x1100W Titanium	5x Std	Opt	Yes	Plat	Yes
7D76A02QEA	1x Silver 4410Y 12C 150W 2.0G	1x64GB	940-8i 4GB	8x 2.5" SAS Open bay	Open	3 (x16, x8, x8) Gen4	1x1100W Titanium	5x Std	Opt	Yes	Plat	Yes
7D76A034EA	1x Silver 4410Y 12C 150W 2.0G	1x64GB	Option	Option 2.5" Open bay	Open	Open	1x1100W Titanium	5x Std	Opt	Yes	Plat	Yes
7D76A04FEA	1x Silver 4410Y 12C 150W 2.0G	1x32GB 1Rx4	Option	Option 2.5" Open bay	Open	Open	1x1100W Titanium	5x Std	Opt	Yes	Plat	Yes
7D76A01SEA	1x Gold 5415+ 8C 150W 2.9G	1x64GB	9350-8i 2GB Int	8x 2.5" SAS Open bay	Open	Open	1x1100W Titanium	5x Perf	Opt	Yes	Plat	Yes
7D76A035EA	1x Gold 5415+ 8C 150W 2.9G	1x64GB	Option	Option 2.5" Open bay	Open	Open	1x1100W Titanium	5x Std	Opt	Yes	Plat	Yes
7D76A04HEA	1x Gold 5415+ 8C 150W 2.9G	1x32GB 1Rx4	Option	Option 2.5" Open bay	Open	Open	1x1100W Titanium	5x Std	Opt	Yes	Plat	Yes
7D76A020EA	1x Gold 5416S 16C 150W 2.0G	1x64GB	9350-8i 2GB Int	8x 2.5" SAS Open bay	Open	Open	1x1100W Titanium	5x Perf	Opt	Yes	Plat	Yes
7D76A02BEA	1x Gold 5416S 16C 150W 2.0G	1x64GB	SATA	12x 3.5" SAS Open bay	Open	Open	1x1100W Titanium	5x Perf	Opt	Yes	Plat	Yes
7D76A02NEA	1x Gold 5416S 16C 150W 2.0G	1x64GB	940-8i 4GB	8x 2.5" SAS Open bay	Open	3 (x16, x8, x8) Gen4	1x1100W Titanium	5x Std	Opt	Yes	Plat	Yes
7D76A02VEA	1x Gold 5416S 16C 150W 2.0G	1x64GB	SATA	8x 3.5" SAS Open bay	Open	Open	1x1100W Titanium	5x Std	Opt	Yes	Plat	Yes
7D76A08JEA	1x Gold 5416S 16C 150W 2.0G	1x32GB 1Rx4	940-8i 4GB	8x 2.5" SAS Open bay	Open	3 (x16, x8, x8) Gen4	1x1100W Titanium	5x Std	Opt	Yes	Plat	Yes
7D76A08REA	1x Gold 5416S 16C 150W 2.0G	1x32GB 1Rx4	9350-8i	8x 2.5" SAS Open bay	Open	3 (x16, x8, x8) Gen4	1x1100W Titanium	5x Std	Opt	Yes	Plat	Yes
7D76A024EA	1x Gold 5418Y 24C 185W 2.0G	1x64GB	9350-8i 2GB Int	8x 2.5" SAS Open bay	Open	Open	1x1100W Titanium	5x Perf	Opt	Yes	Plat	Yes
7D76A02MEA	1x Gold 5418Y 24C 185W 2.0G	1x64GB	940-8i 4GB	8x 2.5" SAS Open bay	Open	3 (x16, x8, x8) Gen4	1x1100W Titanium	5x Std	Opt	Yes	Plat	Yes
7D76A036EA	1x Gold 5418Y 24C 185W 2.0G	1x64GB	Option	Option 2.5" Open bay	Open	Open	1x1100W Titanium	5x Std	Opt	Yes	Plat	Yes
7D76A04GEA	1x Gold 5418Y 24C 185W 2.0G	1x32GB 1Rx4	Option	Option 2.5" Open bay	Open	Open	1x1100W Titanium	5x Std	Opt	Yes	Plat	Yes
7D76A028EA	1x Gold 6426Y 16C 185W 2.5G	1x64GB	9350-8i 2GB Int	8x 2.5" SAS Open bay	Open	Open	1x1100W Titanium	5x Perf	Opt	Yes	Plat	Yes
7D76A02CEA	1x Gold 6426Y 16C 185W 2.5G	1x64GB	SATA	12x 3.5" SAS Open bay	Open	Open	1x1100W Titanium	5x Perf	Opt	Yes	Plat	Yes
7D76A038EA	1x Gold 6426Y 16C 185W 2.5G	1x64GB	Option	Option 2.5" Open bay	Open	Open	1x1100W Titanium	5x Std	Opt	Yes	Plat	Yes
7D76A04DEA	1x Gold 6426Y 16C 185W 2.5G	1x32GB 1Rx4	Option	Option 2.5" Open bay	Open	Open	1x1100W Titanium	5x Std	Opt	Yes	Plat	Yes
7D76A02FEA	1x Gold 6430 32C 270W 2.1G	1x64GB	940-8i 4GB	8x 2.5" SAS Open bay	Open	3 (x16, x8, x8) Gen4	1x1100W Titanium	5x Perf	Opt	Yes	Plat	Yes
7D76A02LEA	1x Gold 6430 32C 270W 2.1G	1x64GB	SATA	12x 3.5" SAS Open bay	Open	Open	1x1100W Titanium	5x Perf	Opt	Yes	Plat	Yes
7D76A02TEA	1x Gold 6430 32C 270W 2.1G	1x64GB	9350-8i 2GB Int	8x 2.5" SAS Open bay	Open	Open	1x1100W Titanium	5x Perf	Opt	Yes	Plat	Yes
7D76A033EA	1x Gold 6430 32C 270W 2.1G	1x64GB	Option	Option 2.5" Open bay	Open	Open	1x1800W Titanium	5x Perf	Opt	Yes	Plat	Yes
7D76A04EEA	1x Gold 6430 32C 270W 2.1G	1x32GB 1Rx4	Option	Option 2.5" Open bay	Open	Open	1x1100W Titanium	5x Perf	Opt	Yes	Plat	Yes

Model	Intel Xeon Scalable processor†	Memory	RAID	Drive bays	OCP	Slots	Power supply	Fans	Front VGA	Front diag	XCC2	Intru switch
7D76A039EA	1x Gold 6434 8C 195W 3.7G	1x64GB	Option	Option 2.5" Open bay	Open	Open	1x1100W Titanium	5x Perf	Opt	Yes	Plat	Yes
7D76A02AEA	1x Gold 6438Y+ 32C 205W 2.0G	1x64GB	9350-8i 2GB Int	8x 2.5" SAS Open bay	Open	Open	1x1100W Titanium	5x Perf	Opt	Yes	Plat	Yes
7D76A037EA	1x Gold 6438Y+ 32C 205W 2.0G	1x64GB	Option	Option 2.5" Open bay	Open	Open	1x1100W Titanium	5x Std	Opt	Yes	Plat	Yes
7D76A02UEA	1x Gold 6444Y 16C 270W 3.6G	1x64GB	9350-8i 2GB Int	8x 2.5" SAS Open bay	Open	Open	1x1100W Titanium	5x Perf	Opt	Yes	Plat	Yes
7D76A031EA	1x Gold 6444Y 16C 270W 3.6G	1x64GB	Option	Option 2.5" Open bay	Open	Open	1x1800W Titanium	5x Perf	Opt	Yes	Plat	Yes
7D76A032EA	1x Gold 6448Y 32C 225W 2.1G	1x64GB	Option	Option 2.5" Open bay	Open	Open	1x1800W Titanium	5x Perf	Opt	Yes	Plat	Yes
7D76A030EA	1x Platinum 8452Y 36C 300W 2.0G	1x64GB	Option	Option 2.5" Open bay	Open	Open	1x1800W Titanium	5x Perf	Opt	Yes	Plat	Yes
7D76A044EA	1x Platinum 8462Y+ 32C 300W 2.8G	1x64GB	Option	Option 2.5" Open bay	Open	Open	1x1800W Titanium	5x Perf	Opt	Yes	Plat	Yes
7D76A045EA	1x Platinum 8462Y+ 32C 300W 2.8G	1x64GB	9350-8i 2GB Int	8x 2.5" SAS Open bay	Open	Open	1x1800W Titanium	5x Perf	Opt	Yes	Plat	Yes

† Processor description: Processor model, number of cores, thermal design power (TDP), core frequency

Models for India

AP models: Customers in India also have access to the [Asia Pacific region](#) models.

Table 12. Models for India

Model	Intel Xeon Scalable processor†	Memory	RAID	Drive bays	OCP	Slots	Power supply	Fans	Front VGA	Front diag	XCC2	Intru switch
TopSeller models with a 3-year warranty (machine type 7D76)												
Models with 5th Gen Intel Xeon Scalable processors												
7D76A074SG	1x Silver 4509Y 8C 125W 2.6G	1x32GB 1Rx4	5350-8i	8x 2.5" SAS Open bay	2x10GT 57416	3 (x16, x8, x8) Gen4 1x 4x1Gb 5719	2x 750W	5x Perf	Opt	Opt	Plat	Opt
7D76A076SG	1x Silver 4509Y 8C 125W 2.6G	1x32GB 2Rx8	5350-8i	8x 2.5" SAS Open bay	2x10GT 57416	3 (x16, x8, x8) Gen4	2x 750W	5x Perf	Opt	Opt	Std	Opt
7D76A084SG	1x Silver 4509Y 8C 125W 2.6G	1x32GB 2Rx8	5350-8i	8x 2.5" SAS Open bay	4x1G 5719	3 (x16, x8, x8) Gen4	1x750W	5x Perf	Yes	Yes	Plat	Yes
7D76A077SG	1x Silver 4510 12C 150W 2.4G	1x32GB 2Rx8	5350-8i	8x 2.5" SAS Open bay	2x10GT 57416	3 (x16, x8, x8) Gen4	2x 750W	5x Perf	Opt	Opt	Std	Opt
7D76A079SG	1x Silver 4510 12C 150W 2.4G	1x32GB 2Rx8	5350-8i	8x 3.5" SAS Open bay	2x10GT 57416	3 (x16, x8, x8) Gen4	2x 750W	5x Perf	Opt	Opt	Std	Opt
7D76A049SG	1x Silver 4514Y 16C 150W 2.0G	1x32GB 2Rx8	5350-8i	8x 2.5" SAS Open bay	2x10GT 57416	3 (x16, x8, x8) Gen4	2x 750W	5x Perf	Yes	Yes	Plat	Yes
7D76A078SG	1x Silver 4514Y 16C 150W 2.0G	1x32GB 2Rx8	Option	8x 2.5" Any Open bay	2x10GT 57416	3 (x16, x8, x8) Gen4	2x 750W	5x Perf	Opt	Opt	Std	Opt
7D76A07ASG	1x Silver 4514Y 16C 150W 2.0G	1x32GB 2Rx8	5350-8i	8x 2.5" SAS Open bay	2x10GT 57416	3 (x16, x8, x8) Gen4	2x 750W	5x Perf	Opt	Opt	Std	Opt
7D76A07BSG	1x Silver 4516Y+ 24C 185W 2.2G	1x32GB 2Rx8	Option	8x 2.5" Any Open bay	2x10GT 57416	3 (x16, x8, x8) Gen4	2x 750W	5x Perf	Opt	Opt	Std	Opt
Models with 4th Gen Intel Xeon Scalable processors												
7D76A03PSG	1x Silver 4410T 10C 150W 2.7G	1x32GB 2Rx8	5350-8i	8x 2.5" SAS Open bay	4x1G 5719	3 (x16, x8, x8) Gen4	1x750W	5x Perf	Yes	Yes	Plat	Yes
7D76A03QSG	1x Silver 4410Y 12C 150W 2.0G	1x32GB 2Rx8	5350-8i	8x 2.5" SAS Open bay	4x1G 5719	3 (x16, x8, x8) Gen4	1x750W	5x Perf	Yes	Yes	Plat	Yes
7D76A086SG	1x Silver 4410Y 12C 150W 2.0G	1x32GB 2Rx8	5350-8i	8x 3.5" SAS Open bay	4x1G 5719	3 (x16, x8, x8) Gen4	1x750W	5x Perf	Yes	Yes	Plat	Yes
7D76A04ASG	1x Silver 4416+ 20C 165W 2.0G	1x32GB 2Rx8	940-8i 4GB	8x 2.5" SAS Open bay	4x10GT 57454	3 (x16, x8, x8) Gen4	1x750W	5x Std	Yes	Yes	Std	Yes
7D76A048SG	1x Gold 5418Y 24C 185W 2.0G	1x32GB 2Rx8	9350-8i	8x 2.5" SAS Open bay	2x10GT 57416	3 (x16, x8, x8) Gen4	2x 750W	5x Std	Yes	Yes	Plat	Yes
7D76A085SG	1x Gold 6416H 18C 165W 2.2G	1x32GB 2Rx8	9350-8i	8x 2.5" SAS Open bay	2x10GT 57416	3 (x16, x8, x8) Gen4	2x 1100W	5x Std	Yes	Yes	Plat	Yes

† Processor description: Processor model, number of cores, thermal design power (TDP), core frequency

Models for Latin American countries (except Brazil)

Table 14. Models with a 3-year warranty for Latin American countries (except Brazil)

Model	Intel Xeon Scalable processor†	Memory	RAID	Drive bays	OCP	Slots	Power supply	Fans	Front VGA	Front diag	XCC2	Intru switch
Standard models with a 3-year warranty (machine type 7D76)												
Models with 5th Gen Intel Xeon Scalable processors												
7D76A07ELA	1x Silver 4509Y 8C 125W 2.6G	1x32GB 1Rx4	9350-8i	8x 2.5" SAS Open bay	Open	3 (x16, x8, x8) Gen4	1x1100W Titanium	5x Std	Opt	Opt	Plat	Yes
7D76A07XLA	1x Gold 6542Y 24C 250W 2.9G	1x32GB 1Rx4	9350-8i	8x 2.5" SAS Open bay 1x M.2 SATA/x4NVMe	2x25G 57414	2 (x16, x16) Gen4 1x 2x25Gb 57414	2x 1100W	5x Perf	Opt	Opt	Plat	Opt
Models with 4th Gen Intel Xeon Scalable processors												
7D76A01ULA	1x Silver 4410T 10C 150W 2.7G	1x16GB	9350-16i	12x 3.5" SAS Open bay	Open	3 (x16, x8, x8) Gen4	1x750W	5x Std	Yes	Yes	Std	Opt
7D76A050LA	1x Silver 4410Y 12C 150W 2.0G	1x32GB 1Rx4	9350-8i	8x 3.5" SAS Open bay 1x M.2 SATA/x4NVMe	2x10GT 57416	3 (x16, x8, x8) Gen4	1x1100W	5x Std	Opt	Opt	Std	Yes
7D76A051LA	1x Silver 4410Y 12C 150W 2.0G	1x32GB 1Rx4	9350-16i	12x 3.5" SAS Open bay 1x M.2 SATA/x4NVMe	2x10GT 57416	3 (x16, x8, x8) Gen4	1x1100W	5x Perf	Opt	Opt	Std	Opt
7D76A07ULA	1x Gold 5416S 16C 150W 2.0G	1x32GB 1Rx4	9350-8i	8x 2.5" SAS Open bay	Open	3 (x16, x8, x8) Gen4	1x1100W Titanium	5x Std	Opt	Opt	Plat	Yes
7D76A04RLA	1x Gold 5418Y 24C 185W 2.0G	1x32GB 1Rx4	9350-8i	8x 2.5" SAS Open bay 1x M.2 SATA/x4NVMe, 2x 960GB 5400 PRO M.2	2x25G 57414	2 (x16, x16) Gen4 1x 2x25Gb 57414	2x 1100W	5x Perf	Opt	Opt	Plat	Opt
7D76A07TLA	1x Gold 5418Y 24C 185W 2.0G	1x32GB 1Rx4	9350-8i	8x 2.5" SAS Open bay	2x25G 57414	2 (x16, x16) Gen4 1x 2x25Gb 57414	1x1100W	5x Perf	Opt	Opt	Plat	Opt
TopSeller models with a 3-year warranty (machine type 7D76)												
Models with 5th Gen Intel Xeon Scalable processors												
7D76A07CLA	1x Silver 4514Y 16C 150W 2.0G	1x32GB 2Rx8	9350-8i	8x 2.5" SAS Open bay	Open	3 (x16, x8, x8) Gen4	2x 750W	5x Perf	Yes	Yes	Std	Opt
7D76A07DLA	1x Silver 4514Y 16C 150W 2.0G	1x32GB 2Rx8	9350-8i	8x 2.5" SAS Open bay	Open	3 (x16, x8, x8) Gen4	1x750W	5x Perf	Yes	Yes	Std	Opt
Models with 4th Gen Intel Xeon Scalable processors												
7D76A03ULA	1x Silver 4416+ 20C 165W 2.0G	1x32GB 1Rx4	9350-8i	8x 2.5" SAS Open bay 1x M.2 SATA/x4NVMe, 2x 960GB 5400 PRO M.2	2x25G 57414	2 (x16, x16) Gen4 1x 2x25Gb 57414	2x 1100W	5x Perf	Opt	Opt	Std	Opt

Model	Intel Xeon Scalable processor†	Memory	RAID	Drive bays	OCP	Slots	Power supply	Fans	Front VGA	Front diag	XCC2	Intru switch
7D76A040LA	1x Silver 4416+ 20C 165W 2.0G	1x32GB 1Rx4	9350-8i	8x 2.5" SAS Open bay 1x M.2 SATA/x4NVMe, 2x 960GB 5400 PRO M.2	2x25G 57414	2 (x16, x16) Gen4 1x 2x25Gb 57414	2x 1100W	5x Perf	Opt	Opt	Std	Opt
7D76A07VLA	1x Gold 5416S 16C 150W 2.0G	1x32GB 1Rx4	5350-8i	8x 3.5" SAS Open bay 1x M.2 SATA/x4NVMe	2x10GT 57416	3 (x16, x8, x8) Gen4	1x1100W	5x Std	Opt	Opt	Std	Yes
7D76A07WLA	1x Gold 5416S 16C 150W 2.0G	1x32GB 1Rx4	5350-8i	8x 3.5" SAS Open bay 1x M.2 SATA/x4NVMe	2x10GT 57416	3 (x16, x8, x8) Gen4	2x 1100W	5x Std	Opt	Opt	Std	Yes
7D76A06ULA	1x Gold 6426Y 16C 185W 2.5G	1x32GB 1Rx4	9350-8i	8x 2.5" SAS Open bay 1x M.2 SATA/x4NVMe, 2x 960GB 5400 PRO M.2	2x25G 57414	2 (x16, x16) Gen4 1x 2x25Gb 57414	2x 1100W	5x Perf	Opt	Opt	Std	Opt

† Processor description: Processor model, number of cores, thermal design power (TDP), core frequency

Models for USA and Canada

Table 15. Models for USA and Canada

Model	Intel Xeon Scalable processor†	Memory	RAID	Drive bays	OCP	Slots	Power supply	Fans	Front VGA	Front diag	XCC2	Intru switch
Standard models with a 3-year warranty (machine type 7D76)												
7D76A07KNA	1x Silver 4509Y 8C 125W 2.6G	1x32GB 2Rx8	SATA	8x 2.5" SAS Open bay	Open	Open	1x750W	5x Std	Yes	Yes	Std	Opt
7D76A07LNA	1x Silver 4509Y 8C 125W 2.6G	1x32GB 2Rx8	940-8i 4GB	8x 2.5" SAS Open bay	Open	3 (x16, x8, x8) Gen5	1x750W	5x Std	Yes	Yes	Std	Opt
7D76A07MNA	1x Silver 4510 12C 150W 2.4G	1x32GB 2Rx8	SATA	8x 2.5" SAS Open bay	Open	Open	1x750W	5x Std	Yes	Yes	Std	Opt
7D76A07NNA	1x Silver 4510 12C 150W 2.4G	1x32GB 2Rx8	940-8i 4GB	8x 2.5" SAS Open bay	Open	3 (x16, x8, x8) Gen5	1x750W	5x Std	Yes	Yes	Std	Opt
7D76A07PNA	1x Silver 4514Y 16C 150W 2.0G	1x32GB 2Rx8	SATA	8x 2.5" SAS Open bay	Open	Open	1x750W	5x Std	Yes	Yes	Std	Opt
7D76A07QNA	1x Silver 4514Y 16C 150W 2.0G	1x32GB 2Rx8	940-8i 4GB	8x 2.5" SAS Open bay	Open	3 (x16, x8, x8) Gen5	1x750W	5x Std	Yes	Yes	Std	Opt

† Processor description: Processor model, number of cores, thermal design power (TDP), core frequency

Processors

The SR650 V3 supports processors in either the 5th Gen Intel Xeon Scalable Processor family or the 4th Gen Intel Xeon Scalable Processor family. The server supports one or two processors.

Topics in this section:

- [Processor options](#)
- [Processor features](#)
- [Intel On Demand feature licensing](#)
- [One-processor configurations](#)
- [Thermal requirements for processors](#)
- [Lenovo Processor Neptune Core Module - Open-loop liquid cooling](#)
- [UEFI operating modes](#)

Processor options

All supported processors have the following characteristics:

- 8 DDR5 memory channels at 2 DIMMs per channel
- Up to 4 UPI links between processors at up to 20 GT/s
- Up to 80 PCIe 5.0 I/O lanes

The following table lists the 5th Gen processors that are currently supported by the SR650 V3.

Table 16. 5th Gen Intel Xeon Processor support

Part number	Feature code	SKU	Description	Quantity supported
CTO only	BYVT	3508U	Intel Xeon Bronze 3508U 8C 125W 2.1GHz Processor	1*
4XG7A91456	BYW3	4509Y	ThinkSystem SR650 V3 Intel Xeon Silver 4509Y 8C 125W 2.6GHz Processor Option Kit w/o Fan	2
4XG7A91455	BYW4	4510	ThinkSystem SR650 V3 Intel Xeon Silver 4510 12C 150W 2.4GHz Processor Option Kit w/o Fan	2
4XG7A91468	BYVS	4510T	ThinkSystem SR650 V3 Intel Xeon Silver 4510T 12C 115W 2.0GHz Processor Option Kit w/o Fan	2
4XG7A91454	BYVP	4514Y	ThinkSystem SR650 V3 Intel Xeon Silver 4514Y 16C 150W 2.0GHz Processor Option Kit w/o Fan	2
4XG7A91453	BYW6	4516Y+	ThinkSystem SR650 V3 Intel Xeon Silver 4516Y+ 24C 185W 2.2GHz Processor Option Kit w/o Fan	2
CTO only	BYVU	5512U	Intel Xeon Gold 5512U 28C 185W 2.1GHz Processor	1*
4XG7A91467	BYVW	5515+	ThinkSystem SR650 V3 Intel Xeon Gold 5515+ 8C 165W 3.2GHz Processor Option Kit w/o Fan	2
4XG7A91452	BYW7	5520+	ThinkSystem SR650 V3 Intel Xeon Gold 5520+ 28C 205W 2.2GHz Processor Option Kit w/o Fan	2
4XG7A91466	BYVX	6526Y	ThinkSystem SR650 V3 Intel Xeon Gold 6526Y 16C 195W 2.8GHz Processor Option Kit w/o Fan	2
4XG7A91451	BYWK	6530	ThinkSystem SR650 V3 Intel Xeon Gold 6530 32C 270W 2.1GHz Processor Option Kit w/o Fan	2
4XG7A91463	BYW0	6534	ThinkSystem SR650 V3 Intel Xeon Gold 6534 8C 195W 3.9GHz Processor Option Kit w/o Fan	2
4XG7A91831	BYVQ	6538N	ThinkSystem SR650 V3 Intel Xeon Gold 6538N 32C 205W 2.1GHz Processor Option Kit w/o Fan	2
4XG7A91450	BYW8	6538Y+	ThinkSystem SR650 V3 Intel Xeon Gold 6538Y+ 32C 225W 2.2GHz Processor Option Kit w/o Fan	2

Part number	Feature code	SKU	Description	Quantity supported
4XG7A91465	BYVY	6542Y	ThinkSystem SR650 V3 Intel Xeon Gold 6542Y 24C 250W 2.9GHz Processor Option Kit w/o Fan	2
4XG7A91462	BYW1	6544Y	ThinkSystem SR650 V3 Intel Xeon Gold 6544Y 16C 270W 3.6GHz Processor Option Kit w/o Fan	2
4XG7A91830	BYVR	6548N	ThinkSystem SR650 V3 Intel Xeon Gold 6548N 32C 250W 2.8GHz Processor Option Kit w/o Fan	2
4XG7A91464	BYVZ	6548Y+	ThinkSystem SR650 V3 Intel Xeon Gold 6548Y+ 32C 250W 2.5GHz Processor Option Kit w/o Fan	2
4XG7A91470	BYW9	6554S	ThinkSystem SR650 V3 Intel Xeon Gold 6554S 36C 270W 2.2GHz Processor Option Kit w/o Fan	2
CTO only	BYVV	6558Q	Intel Xeon Gold 6558Q 32C 350W 3.2GHz Processor	2
4XG7A91449	BYW5	8558	ThinkSystem SR650 V3 Intel Xeon Platinum 8558 48C 330W 2.1GHz Processor Option Kit w/o Fan	2
4XG7A91469	BYWA	8558P	ThinkSystem SR650 V3 Intel Xeon Platinum 8558P 48C 350W 2.7GHz Processor Option Kit w/o Fan	2
CTO only	BYWE	8558U	Intel Xeon Platinum 8558U 48C 300W 2.0GHz Processor	1*
4XG7A91461	BYW2	8562Y+	ThinkSystem SR650 V3 Intel Xeon Platinum 8562Y+ 32C 300W 2.8GHz Processor Option Kit w/o Fan	2
4XG7A91460	BYWF	8568Y+	ThinkSystem SR650 V3 Intel Xeon Platinum 8568Y+ 48C 350W 2.3GHz Processor Option Kit w/o Fan	2
4XG7A91459	BYWG	8570	ThinkSystem SR650 V3 Intel Xeon Platinum 8570 56C 350W 2.1GHz Processor Option Kit w/o Fan	2
CTO only	BYWD	8571N	Intel Xeon Platinum 8571N 52C 300W 2.4GHz Processor	1*
4XG7A91458	BYWH	8580	ThinkSystem SR650 V3 Intel Xeon Platinum 8580 60C 350W 2.0GHz Processor Option Kit w/o Fan	2
CTO only	BYWC	8581V	Intel Xeon Platinum 8581V 60C 270W 2.0GHz Processor	1*
4XG7A91457	BYWJ	8592+	ThinkSystem SR650 V3 Intel Xeon Platinum 8592+ 64C 350W 1.9GHz Processor Option Kit w/o Fan	2
4XG7A91832	BYWB	8592V	ThinkSystem SR650 V3 Intel Xeon Platinum 8592V 64C 330W 2.0GHz Processor Option Kit w/o Fan	2
CTO only	BYXG	8593Q	Intel Xeon Platinum 8593Q 64C 385W 2.2GHz Processor	2

* These processors are single-socket capable processors and are only available in configure-to-order builds or in preconfigured models. Not available as option part numbers.

The following table lists the 4th Gen processors that are currently supported by the SR650 V3.

Table 17. 4th Gen Intel Xeon Processor support

Part number	Feature code	SKU	Description	Maximum quantity
CTO only	BQ68	3408U	Intel Xeon Bronze 3408U 8C 125W 1.8GHz Processor	1*
4XG7A84164	BQ64	4410T	ThinkSystem SR650 V3 Intel Xeon Silver 4410T 10C 150W 2.7GHz Processor Option Kit w/o Fan	2
4XG7A84167	BQ67	4410Y	ThinkSystem SR650 V3 Intel Xeon Silver 4410Y 12C 150W 2.0GHz Processor Option Kit w/o Fan	2
4XG7A84169	BQ69	4416+	ThinkSystem SR650 V3 Intel Xeon Silver 4416+ 20C 165W 2.0GHz Processor Option Kit w/o Fan	2
CTO only	BQ6J	5411N	Intel Xeon Gold 5411N 24C 165W 1.9GHz Processor	1*

Part number	Feature code	SKU	Description	Maximum quantity
CTO only	BU1V	5412U	Intel Xeon Gold 5412U 24C 185W 2.1GHz Processor	1*
4XG7A84163	BQ63	5415+	ThinkSystem SR650 V3 Intel Xeon Gold 5415+ 8C 150W 2.9GHz Processor Option Kit w/o Fan	2
4XG7A84178	BQ6L	5416S	ThinkSystem SR650 V3 Intel Xeon Gold 5416S 16C 150W 2.0GHz Processor Option Kit w/o Fan	2
4XG7A84176	BQ6H	5418N	ThinkSystem SR650 V3 Intel Xeon Gold 5418N 24C 165W 1.8GHz Processor Option Kit w/o Fan	2
4XG7A84166	BQ66	5418Y	ThinkSystem SR650 V3 Intel Xeon Gold 5418Y 24C 185W 2.0GHz Processor Option Kit w/o Fan	2
4XG7A84165	BQ65	5420+	ThinkSystem SR650 V3 Intel Xeon Gold 5420+ 28C 205W 2.0GHz Processor Option Kit w/o Fan	2
CTO only	BXHX	5423N	Intel Xeon Gold 5423N 20C 145W 2.1GHz Processor	1*
CTO only	BXHY	5433N	Intel Xeon Gold 5433N 20C 160W 2.3GHz Processor	1*
CTO only	BYQK	6403N	Intel Xeon Gold 6403N 24C 185W 1.9GHz Processor	1*
CTO only	BPPD	6414U	Intel Xeon Gold 6414U 32C 250W 2.0GHz Processor	1*
4XG7A84172	BQ6C	6416H	ThinkSystem SR650 V3 Intel Xeon Gold 6416H 18C 165W 2.2GHz Processor Option Kit w/o Fan	2
4XG7A84171	BQ6B	6418H	ThinkSystem SR650 V3 Intel Xeon Gold 6418H 24C 185W 2.1GHz Processor Option Kit w/o Fan	2
CTO only	BQ6G	6421N	Intel Xeon Gold 6421N 32C 185W 1.8GHz Processor	1*
CTO only	BYQH	6423N	Intel Xeon Gold 6423N 28C 195W 2.0GHz Processor	1*
4XG7A84160	BPQF	6426Y	ThinkSystem SR650 V3 Intel Xeon Gold 6426Y 16C 185W 2.5GHz Processor Option Kit w/o Fan	2
4XG7A84175	BQ6F	6428N	ThinkSystem SR650 V3 Intel Xeon Gold 6428N 32C 185W 1.8GHz Processor Option Kit w/o Fan	2
4XG7A82861	BPPC	6430	ThinkSystem SR650 V3 Intel Xeon Gold 6430 32C 270W 2.1GHz Processor Option Kit w/o Fan	2
CTO only	BYQJ	6433N	Intel Xeon Gold 6433N 32C 205W 2.0GHz Processor	1*
4XG7A84158	BPQC	6434	ThinkSystem SR650 V3 Intel Xeon Gold 6434 8C 195W 3.7GHz Processor Option Kit w/o Fan	2
4XG7A84174	BQ6E	6434H	ThinkSystem SR650 V3 Intel Xeon Gold 6434H 8C 195W 3.7GHz Processor Option Kit w/o Fan	2
4XG7A84177	BQ6K	6438M	ThinkSystem SR650 V3 Intel Xeon Gold 6438M 32C 205W 2.2GHz Processor Option Kit w/o Fan	2
4XG7A84173	BQ6D	6438N	ThinkSystem SR650 V3 Intel Xeon Gold 6438N 32C 205W 2.0GHz Processor Option Kit w/o Fan	2
4XG7A84161	BQ62	6438Y+	ThinkSystem SR650 V3 Intel Xeon Gold 6438Y+ 32C 205W 2.0GHz Processor Option Kit w/o Fan	2
4XG7A84159	BPQE	6442Y	ThinkSystem SR650 V3 Intel Xeon Gold 6442Y 24C 225W 2.6GHz Processor Option Kit w/o Fan	2
CTO only	BYQG	6443N	Intel Xeon Gold 6443N 32C 195W 1.6GHz Processor	1*
4XG7A84157	BPQB	6444Y	ThinkSystem SR650 V3 Intel Xeon Gold 6444Y 16C 270W 3.6GHz Processor Option Kit w/o Fan	2
4XG7A84170	BQ6A	6448H	ThinkSystem SR650 V3 Intel Xeon Gold 6448H 32C 250W 2.4GHz Processor Option Kit w/o Fan	2
4XG7A84162	BPQD	6448Y	ThinkSystem SR650 V3 Intel Xeon Gold 6448Y 32C 225W 2.1GHz Processor Option Kit w/o Fan	2

Part number	Feature code	SKU	Description	Maximum quantity
4XG7A82872	BPPM	6454S	ThinkSystem SR650 V3 Intel Xeon Gold 6454S 32C 270W 2.2GHz Processor Option Kit w/o Fan	2
CTO only	BPQG	6458Q	Intel Xeon Gold 6458Q 32C 350W 3.1GHz Processor	2
4XG7A82869	BPPH	8444H	ThinkSystem SR650 V3 Intel Xeon Platinum 8444H 16C 270W 2.9GHz Processor Option Kit w/o Fan	2
4XG7A82867	BPPG	8450H	ThinkSystem SR650 V3 Intel Xeon Platinum 8450H 28C 250W 2.0GHz Processor Option Kit w/o Fan	2
4XG7A82862	BPPB	8452Y	ThinkSystem SR650 V3 Intel Xeon Platinum 8452Y 36C 300W 2.0GHz Processor Option Kit w/o Fan	2
4XG7A82866	BPPF	8454H	ThinkSystem SR650 V3 Intel Xeon Platinum 8454H 32C 270W 2.1GHz Processor Option Kit w/o Fan	2
4XG7A82879	BPPT	8458P	ThinkSystem SR650 V3 Intel Xeon Platinum 8458P 44C 350W 2.7GHz Processor Option Kit w/o Fan	2
4XG7A82865	BPPN	8460H	ThinkSystem SR650 V3 Intel Xeon Platinum 8460H 40C 330W 2.2GHz Processor Option Kit w/o Fan	2
4XG7A82873	BPPQ	8460Y+	ThinkSystem SR650 V3 Intel Xeon Platinum 8460Y+ 40C 300W 2.0GHz Processor Option Kit w/o Fan	2
CTO only	BPPK	8461V	Intel Xeon Platinum 8461V 48C 300W 2.2GHz Processor	1*
4XG7A86665	BPQA	8462Y+	ThinkSystem SR650 V3 Intel Xeon Platinum 8462Y+ 32C 300W 2.8GHz Processor Option Kit w/o Fan	2
4XG7A82880	BPPU	8468	ThinkSystem SR650 V3 Intel Xeon Platinum 8468 48C 350W 2.1GHz Processor Option Kit w/o Fan	2
4XG7A82864	BPPE	8468H	ThinkSystem SR650 V3 Intel Xeon Platinum 8468H 48C 330W 2.1GHz Processor Option Kit w/o Fan	2
4XG7A82875	BPPP	8468V	ThinkSystem SR650 V3 Intel Xeon Platinum 8468V 48C 330W 2.4GHz Processor Option Kit w/o Fan	2
4XG7A82881	BN0N	8470	ThinkSystem SR650 V3 Intel Xeon Platinum 8470 52C 350W 2.0GHz Processor Option Kit w/o Fan	2
4XG7A82870	BPPJ	8470N	ThinkSystem SR650 V3 Intel Xeon Platinum 8470N 52C 300W 1.7GHz Processor Option Kit w/o Fan	2
CTO only	BN0P	8470Q	Intel Xeon Platinum 8470Q 52C 350W 2.1GHz Processor	2
CTO only	BPPR	8471N	Intel Xeon Platinum 8471N 52C 300W 1.8GHz Processor	1*
4XG7A82882	BN0M	8480+	ThinkSystem SR650 V3 Intel Xeon Platinum 8480+ 56C 350W 2.0GHz Processor Option Kit w/o Fan	2
4XG7A90892	BXNW	8480CL	ThinkSystem SR650 V3 Intel Xeon Platinum 8480CL 56C 350W 2.0GHz Processor Option Kit w/o Fan	2
4XG7A82878	BPPS	8490H	ThinkSystem SR650 V3 Intel Xeon Platinum 8490H 60C 350W 1.9GHz Processor Option Kit w/o Fan	2

* These processors are single-socket capable processors and are only available in configure-to-order builds or in preconfigured models. Not available as option part numbers.

Configuration notes:

- Processor options include a heatsink but do not include a system fan

Processor features

Processors supported by the SR650 V3 introduce new embedded accelerators to add even more processing capability:

- **QuickAssist Technology (Intel QAT)**
Help reduce system resource consumption by providing accelerated cryptography, key protection, and data compression with Intel QuickAssist Technology (Intel QAT). By offloading encryption and decryption, this built-in accelerator helps free up processor cores and helps systems serve a larger number of clients.
- **Intel Dynamic Load Balancer (Intel DLB)**
Improve the system performance related to handling network data on multi-core Intel Xeon Scalable processors. Intel Dynamic Load Balancer (Intel DLB) enables the efficient distribution of network processing across multiple CPU cores/threads and dynamically distributes network data across multiple CPU cores for processing as the system load varies. Intel DLB also restores the order of networking data packets processed simultaneously on CPU cores.
- **Intel Data Streaming Accelerator (Intel DSA)**
Drive high performance for storage, networking, and data-intensive workloads by improving streaming data movement and transformation operations. Intel Data Streaming Accelerator (Intel DSA) is designed to offload the most common data movement tasks that cause overhead in data center-scale deployments. Intel DSA helps speed up data movement across the CPU, memory, and caches, as well as all attached memory, storage, and network devices.
- **Intel In-Memory Analytics Accelerator (Intel IAA)**
Run database and analytics workloads faster, with potentially greater power efficiency. Intel In-Memory Analytics Accelerator (Intel IAA) increases query throughput and decreases the memory footprint for in-memory database and big data analytics workloads. Intel IAA is ideal for in-memory databases, open source databases and data stores like RocksDB, Redis, Cassandra, and MySQL.
- **Intel Advanced Matrix Extensions (Intel AMX)**
Intel Advanced Matrix Extensions (Intel AMX) is a built-in accelerator in all Silver, Gold, and Platinum processors that significantly improves deep learning training and inference. With Intel AMX, you can fine-tune deep learning models or train small to medium models in just minutes. Intel AMX offers discrete accelerator performance without added hardware and complexity.

The processors also support a separate and encrypted memory space, known as the SGX Enclave, for use by Intel Software Guard Extensions (SGX). The size of the SGX Enclave supported varies by processor model. Intel SGX offers hardware-based memory encryption that isolates specific application code and data in memory. It allows user-level code to allocate private regions of memory (enclaves) which are designed to be protected from processes running at higher privilege levels.

The following table summarizes the key features of all supported 5th Gen processors in the SR650 V3.

Table 18. 5th Gen Intel Xeon Processor features

CPU model	Cores/ threads	Core speed (Base / TB max†)	L3 cache*	Max memory speed	UPI 2.0 links & speed	PCIe lanes	TDP	Accelerators				SGX Enclave Size
								QAT	DLB	DSA	IAA	
3508U	8 / 8**	2.1 / 2.2 GHz	22.5 MB*	4400 MHz	None‡	80	125W	0	0	1	0	64GB
4509Y	8 / 16	2.6 / 4.1 GHz	22.5 MB*	4400 MHz	2 / 16 GT/s	80	125W	0	0	1	0	64GB
4510	12 / 24	2.4 / 4.1 GHz	30 MB*	4400 MHz	2 / 16 GT/s	80	150W	0	0	1	0	64GB
4510T	12 / 24	2.0 / 3.7 GHz	30 MB*	4400 MHz	2 / 16 GT/s	80	115W	0	0	1	0	64GB
4514Y	16 / 32	2.0 / 3.4 GHz	30 MB	4400 MHz	2 / 16 GT/s	80	150W	0	0	1	0	64GB
4516Y+	24 / 48	2.2 / 3.7 GHz	45 MB	4400 MHz	2 / 16 GT/s	80	185W	1	1	1	1	64GB
5512U	28 / 56	2.1 / 3.7 GHz	52.5 MB	4800 MHz	None‡	80	185W	0	0	1	0	128GB
5515+	8 / 16	3.2 / 4.1 GHz	22.5 MB*	4800 MHz	3 / 20 GT/s	80	165W	1	1	1	1	128GB
5520+	28 / 56	2.2 / 4.0 GHz	52.5 MB	4800 MHz	3 / 20 GT/s	80	205W	1	1	1	1	128GB
6526Y	16 / 32	2.8 / 3.9 GHz	37.5 MB*	5200 MHz	3 / 20 GT/s	80	195W	0	0	1	0	128GB
6530	32 / 64	2.1 / 4.0 GHz	160 MB*	4800 MHz	3 / 20 GT/s	80	270W	0	0	1	0	128GB
6534	8 / 16	3.9 / 4.2 GHz	22.5 MB*	4800 MHz	3 / 20 GT/s	80	195W	0	0	1	0	128GB
6538N	32 / 64	2.1 / 4.1 GHz	60 MB	5200 MHz	3 / 20 GT/s	80	205W	2	2	1	0	128GB
6538Y+	32 / 64	2.2 / 4.0 GHz	60 MB	5200 MHz	3 / 20 GT/s	80	225W	1	1	1	1	128GB
6542Y	24 / 48	2.9 / 4.1 GHz	60 MB*	5200 MHz	3 / 20 GT/s	80	250W	0	0	1	0	128GB
6544Y	16 / 32	3.6 / 4.1 GHz	45 MB*	5200 MHz	3 / 20 GT/s	80	270W	0	0	1	0	128GB
6548N	32 / 64	2.8 / 4.1 GHz	60 MB	5200 MHz	3 / 20 GT/s	80	250W	2	2	1	0	128GB
6548Y+	32 / 64	2.5 / 4.1 GHz	60 MB	5200 MHz	3 / 20 GT/s	80	250W	1	1	1	1	128GB
6554S	36 / 72	2.2 / 4.0 GHz	180 MB*	5200 MHz	4 / 20 GT/s	80	270W	4	4	4	0	128GB
6558Q	32 / 64	3.2 / 4.1 GHz	60 MB	5200 MHz	3 / 20 GT/s	80	350W	0	0	1	0	128GB
8558	48 / 96	2.1 / 4.0 GHz	260 MB*	5200 MHz	4 / 20 GT/s	80	330W	0	0	1	0	512GB
8558P	48 / 96	2.7 / 4.0 GHz	260 MB*	5600 MHz	3 / 20 GT/s	80	350W	1	1	1	1	512GB
8558U	48 / 96	2.0 / 4.0 GHz	260 MB*	4800 MHz	None‡	80	300W	0	0	1	0	512GB
8562Y+	32 / 64	2.8 / 4.1 GHz	60 MB	5600 MHz	3 / 20 GT/s	80	300W	1	1	1	1	512GB
8568Y+	48 / 96	2.3 / 4.0 GHz	300 MB*	5600 MHz	4 / 20 GT/s	80	350W	1	1	1	1	512GB
8570	56 / 112	2.1 / 4.0 GHz	300 MB*	5600 MHz	4 / 20 GT/s	80	350W	0	0	1	0	512GB
8571N	52 / 104	2.4 / 4.0 GHz	300 MB*	4800 MHz	None‡	80	300W	4	4	4	4	512GB
8580	60 / 120	2.0 / 4.0 GHz	300 MB*	5600 MHz	4 / 20 GT/s	80	350W	0	0	1	0	512GB
8581V	60 / 120	2.0 / 3.9 GHz	300 MB*	4800 MHz	None‡	80	270W	1	1	1	1	512GB
8592+	64 / 128	1.9 / 3.9 GHz	320 MB*	5600 MHz	4 / 20 GT/s	80	350W	1	1	1	1	512GB
8592V	64 / 128	2.0 / 3.9 GHz	320 MB*	4800 MHz	3 / 20 GT/s	80	330W	1	1	1	1	512GB
8593Q	64 / 128	2.2 / 3.9 GHz	320 MB*	5600 MHz	4 / 20 GT/s	80	385W	1	1	1	1	512GB

† The maximum single-core frequency at with the processor is capable of operating

* L3 cache is 1.875 MB per core or larger. Processors with a larger L3 cache per core are marked with an *

** Bronze 3508U aprocessor does not support Hyper-Threading Technology

‡ SKUs with a U suffix as well as some other SKUs have no UPI links and are are single-socket only

The following table summarizes the key features of all supported 4th Gen processors in the SR650 V3.

Table 19. 4th Gen Intel Xeon Processor features

CPU model	Cores/ threads	Core speed (Base / TB max†)	L3 cache*	Max memory speed	UPI 2.0 links & speed	PCIe lanes	TDP	Accelerators				SGX Enclave Size
								QAT	DLB	DSA	IAA	
3408U	8 / 8**	1.8 / 1.9 GHz	22.5 MB*	4000 MHz	None‡	80	125W	0	0	1	0	64GB
4410T	10 / 20	2.7 / 4.0 GHz	26.25 MB*	4000 MHz	2 / 16 GT/s	80	150W	0	0	1	0	64GB
4410Y	12 / 24	2.0 / 3.9 GHz	30 MB*	4000 MHz	2 / 16 GT/s	80	150W	0	0	1	0	64GB

CPU model	Cores/ threads	Core speed (Base / TB max†)	L3 cache*	Max memory speed	UPI 2.0 links & speed	PCIe lanes	TDP	Accelerators				SGX Enclave Size
								QAT	DLB	DSA	IAA	
4416+	20 / 40	2.0 / 3.9 GHz	37.5 MB	4000 MHz	2 / 16 GT/s	80	165W	1	1	1	1	64GB
5411N	24 / 48	1.9 / 3.9 GHz	45 MB	4400 MHz	None‡	80	165W	2	2	1	0	128GB
5412U	24 / 48	2.1 / 3.9 GHz	45 MB	4400 MHz	None‡	80	185W	0	0	1	0	128GB
5415+	8 / 16	2.9 / 4.1 GHz	22.5 MB*	4400 MHz	3 / 16 GT/s	80	150W	1	1	1	1	128GB
5416S	16 / 32	2.0 / 4.0 GHz	30 MB	4400 MHz	3 / 16 GT/s	80	150W	2	2	1	0	128GB
5418N	24 / 48	1.8 / 3.8 GHz	45 MB	4000 MHz	3 / 16 GT/s	80	165W	2	2	1	0	128GB
5418Y	24 / 48	2.0 / 3.8 GHz	45 MB	4400 MHz	3 / 16 GT/s	80	185W	0	0	1	0	128GB
5420+	28 / 56	2.0 / 4.1 GHz	52.5 MB	4400 MHz	3 / 16 GT/s	80	205W	1	1	1	1	128GB
5423N	20 / 40	2.1 / 4.0 GHz	37.5 MB	4000 MHz	None‡	48	145W	0	0	1	0	128GB
5433N	24 / 48	1.9 / 3.6 GHz	45 MB	4000 MHz	None‡	48	160W	0	0	1	0	128GB
6403N	24 / 48	1.9 / 3.6 GHz	45 MB	4000 MHz	None‡	64	185W	0	0	1	0	128GB
6414U	32 / 64	2.0 / 3.4 GHz	60 MB	4800 MHz	None‡	80	250W	0	0	1	0	128GB
6416H	18 / 36	2.2 / 4.2 GHz	45 MB*	4800 MHz	3 / 16 GT/s	80	165W	0	0	1	1	512GB
6418H	24 / 48	2.1 / 4.0 GHz	60 MB*	4800 MHz	3 / 16 GT/s	80	185W	0	0	1	1	512GB
6421N	32 / 64	1.8 / 3.6 GHz	60 MB	4400 MHz	None‡	80	185W	0	0	1	0	128GB
6423N	28 / 56	2.0 / 3.6 GHz	52.5 MB	4400 MHz	None‡	64	195W	0	0	1	0	128GB
6426Y	16 / 32	2.5 / 4.1 GHz	37.5 MB*	4800 MHz	3 / 16 GT/s	80	185W	0	0	1	0	128GB
6428N	32 / 64	1.8 / 3.8 GHz	60 MB	4000 MHz	3 / 16 GT/s	80	185W	2	2	1	0	128GB
6430	32 / 64	2.1 / 3.4 GHz	60 MB	4400 MHz	3 / 16 GT/s	80	270W	0	0	1	0	128GB
6433N	32 / 64	2.0 / 3.6 GHz	60 MB	4400 MHz	None‡	64	205W	0	0	1	0	128GB
6434	8 / 16	3.7 / 4.1 GHz	22.5 MB*	4800 MHz	3 / 16 GT/s	80	195W	0	0	1	0	128GB
6434H	8 / 16	3.7 / 4.1 GHz	22.5 MB*	4800 MHz	3 / 16 GT/s	80	195W	0	0	1	1	512GB
6438M	32 / 64	2.2 / 3.9 GHz	60 MB	4800 MHz	3 / 16 GT/s	80	205W	0	0	1	1	128GB
6438N	32 / 64	2.0 / 3.6 GHz	60 MB	4800 MHz	3 / 16 GT/s	80	205W	2	2	1	0	128GB
6438Y+	32 / 64	2.0 / 4.0 GHz	60 MB	4800 MHz	3 / 16 GT/s	80	205W	1	1	1	1	128GB
6442Y	24 / 48	2.6 / 4.0 GHz	60 MB*	4800 MHz	3 / 16 GT/s	80	225W	0	0	1	0	128GB
6443N	32 / 64	2.0 / 3.6 GHz	60 MB	4400 MHz	None‡	64	195W	0	0	1	0	128GB
6444Y	16 / 32	3.6 / 4.1 GHz	45 MB*	4800 MHz	3 / 16 GT/s	80	270W	0	0	1	0	128GB
6448H	32 / 64	2.4 / 4.1 GHz	60 MB	4800 MHz	3 / 16 GT/s	80	250W	2	2	1	1	512GB
6448Y	32 / 64	2.1 / 4.1 GHz	60 MB	4800 MHz	3 / 16 GT/s	80	225W	0	0	1	0	128GB
6454S	32 / 64	2.2 / 3.4 GHz	60 MB	4800 MHz	4 / 16 GT/s	80	270W	4	4	4	0	128GB
6458Q	32 / 64	3.1 / 4.0 GHz	60 MB	4800 MHz	3 / 16 GT/s	80	350W	0	0	1	0	128GB
8444H	16 / 32	2.9 / 4.0 GHz	45 MB*	4800 MHz	4 / 16 GT/s	80	270W	0	0	4	4	512GB
8450H	28 / 56	2.0 / 3.5 GHz	75 MB*	4800 MHz	4 / 16 GT/s	80	250W	0	0	4	4	512GB
8452Y	36 / 72	2.0 / 3.2 GHz	67.5 MB	4800 MHz	4 / 16 GT/s	80	300W	0	0	1	0	128GB
8454H	32 / 64	2.1 / 3.4 GHz	82.5 MB*	4800 MHz	4 / 16 GT/s	80	270W	4	4	4	4	512GB
8458P	44 / 88	2.7 / 3.8 GHz	82.5 MB	4800 MHz	3 / 16 GT/s	80	350W	1	1	1	1	512GB
8460H	40 / 80	2.2 / 3.8 GHz	105 MB*	4800 MHz	4 / 16 GT/s	80	330W	0	0	4	4	512GB
8460Y+	40 / 80	2.0 / 3.7 GHz	105 MB*	4800 MHz	4 / 16 GT/s	80	300W	1	1	1	1	128GB
8461V	48 / 96	2.2 / 3.7 GHz	97.5 MB*	4800 MHz	None‡	80	300W	1	1	1	1	128GB
8462Y+	32 / 64	2.8 / 4.1 GHz	60 MB	4800 MHz	3 / 16 GT/s	80	300W	1	1	1	1	128GB
8468	48 / 96	2.1 / 3.8 GHz	105 MB*	4800 MHz	4 / 16 GT/s	80	350W	0	0	1	0	512GB
8468H	48 / 96	2.1 / 3.8 GHz	105 MB*	4800 MHz	4 / 16 GT/s	80	330W	4	4	4	4	512GB
8468V	48 / 96	2.4 / 3.8 GHz	97.5 MB*	4800 MHz	3 / 16 GT/s	80	330W	1	1	1	1	128GB
8470	52 / 104	2.0 / 3.8 GHz	105 MB*	4800 MHz	4 / 16 GT/s	80	350W	0	0	1	0	512GB
8470N	52 / 104	1.7 / 3.6 GHz	97.5 MB	4800 MHz	4 / 16 GT/s	80	300W	4	4	4	0	128GB

CPU model	Cores/ threads	Core speed (Base / TB max†)	L3 cache*	Max memory speed	UPI 2.0 links & speed	PCIe lanes	TDP	Accelerators				SGX Enclave Size
								QAT	DLB	DSA	IAA	
8470Q	52 / 104	2.1 / 3.8 GHz	105 MB*	4800 MHz	4 / 16 GT/s	80	350W	0	0	1	0	512GB
8471N	52 / 104	1.8 / 3.6 GHz	97.5 MB	4800 MHz	None‡	80	300W	4	4	4	0	128GB
8480+	56 / 112	2.0 / 3.8 GHz	105 MB	4800 MHz	4 / 16 GT/s	80	350W	1	1	1	1	512GB
8480CL	56 / 112	2.0 / 3.8 GHz	105 MB	4800 MHz	4 / 16 GT/s	80	350W	1	1	1	1	512GB
8490H	60 / 120	1.9 / 3.5 GHz	112.5 MB	4800 MHz	4 / 16 GT/s	80	350W	4	4	4	4	512GB

† The maximum single-core frequency at with the processor is capable of operating

* L3 cache is 1.875 MB per core or larger. Processors with a larger L3 cache per core are marked with an *

** Bronze 3408U processor does not support Hyper-Threading Technology

‡ SKUs with a U suffix as well as some other SKUs have no UPI links and are are single-socket only

Intel On Demand feature licensing

Intel On Demand is a licensing offering from Lenovo for certain 4th Gen and 5th Gen Intel Xeon Scalable processors that implements software-defined silicon (SDSi) features. The licenses allow customers to activate the embedded accelerators and to increase the SGX Enclave size in specific processor models as their workload and business needs change.

The available upgrades are the following:

- Up to 4x QuickAssist Technology (Intel QAT) accelerators
- Up to 4x Intel Dynamic Load Balancer (Intel DLB) accelerators
- Up to 4x Intel Data Streaming Accelerator (Intel DSA) accelerators
- Up to 4x Intel In-Memory Analytics Accelerator (Intel IAA) accelerators
- 512GB SGX Enclave, an encrypted memory space for use by Intel Software Guard Extensions (SGX)

See the [Processor features](#) section for a brief description of each accelerator and the SGX Enclave.

The following table lists the ordering information for the licenses. Accelerator licenses are bundled together based on the suitable workloads each would benefit with the additional accelerators.

Licenses can be activated in the factory (CTO orders) using feature codes, or as field upgrades using the option part numbers. With the field upgrades, they allow customers to only activate the accelerators or to increase the SGX Enclave size when their applications can best take advantage of them.

Intel On Demand is licensed on individual processors. For servers with two processors, customers will need a license for each processor and the licenses of the two processors must match. If customers add a second processor as a field upgrade, then you must ensure that the Intel On Demand licenses match the first processor.

Each license enables a certain quantity of embedded accelerators - the total number of accelerators available after activation is listed in the table. For example, Intel On Demand Communications & Storage Suite 4 (4L47A89451), once applied to the server, will result in a total of 4x QAT, 4x DLB and 4x DSA accelerators to be enabled the processor. The number of IAA accelerators is unchanged in this example.

Table 20. Ordering information for Intel on Demand

Part number	Feature code	License bundle	Accelerators and SGX Enclave enabled after the upgrade is applied (NC = No change)				
			QAT	DLB	DSA	IAA	SGX Enclave
4L47A89451	BX9C	Intel On Demand Communications & Storage Suite 4 (CSS4)	4	4	4	NC	No change
4L47A89452	BX9D	Intel On Demand Analytics Suite 4 (AS4)	NC	NC	4	4	No change
4L47A89453	BX9A	Intel On Demand Communications & Storage Suite 2 (CSS2)	2	2	NC	NC	No change
4L47A89454	BX9B	Intel On Demand Analytics Suite 1 (AS1)	NC	NC	NC	1	No change
4L47A89455	BX9E	Intel On Demand SGX 512GB Enclave	NC	NC	NC	NC	512 GB

The following table lists the 5th Gen processors that support Intel on Demand. The table shows the default accelerators and default SGX Enclave size, and it shows (with green highlight) what the total new accelerators and SGX Enclave would be once the Intel On Demand features have been activated.

Table 21. Intel On Demand support by processor - 5th Gen processors

CPU model	Default accelerators and SGX Enclave					Intel On Demand upgrades					New accelerator quantities and SGX Enclave after applying Intel On Demand				
	QAT	DLB	DSA	IAA	SGX Enclv	BX9C	BX9D	BX9A	BX9B	BX9E	Green = additional accelerators/enclave added				
						CSS4 (4xQAT, 4xDLB, 4xDSA)	AS4 (4xDSA, 4xIAA)	CSS2 (2xQAT, 2xDLB)	AS1 (1xIAA)	SGX512	QAT	DLB	DSA	IAA	SGX Enclv
3508U	0	0	1	0	64GB	No	No	No	No	No	N/A	N/A	N/A	N/A	N/A
4509Y	0	0	1	0	64GB	No	No	No	Support	Support	0	0	1	1	512GB
4510	0	0	1	0	64GB	No	No	No	Support	Support	0	0	1	1	512GB
4510T	0	0	1	0	64GB	No	No	No	Support	Support	0	0	1	1	512GB
4514Y	0	0	1	0	64GB	No	No	No	Support	Support	0	0	1	1	512GB
4516Y+	1	1	1	1	64GB	No	No	Support	No	Support	2	2	1	1	512GB
5512U	0	0	1	0	128GB	No	No	No	Support	Support	0	0	1	1	512GB
5515+	1	1	1	1	128GB	No	No	Support	No	Support	2	2	1	1	512GB
5520+	1	1	1	1	128GB	No	No	Support	No	Support	2	2	1	1	512GB
6526Y	0	0	1	0	128GB	No	No	No	Support	Support	0	0	1	1	512GB
6530	0	0	1	0	128GB	No	Support	No	No	Support	0	0	4	4	512GB
6534	0	0	1	0	128GB	No	No	No	Support	Support	0	0	1	1	512GB
6538N	2	2	1	0	128GB	No	No	No	Support	Support	2	2	1	1	512GB
6538Y+	1	1	1	1	128GB	No	No	Support	No	Support	2	2	1	1	512GB
6542Y	0	0	1	0	128GB	No	No	No	Support	Support	0	0	1	1	512GB
6544Y	0	0	1	0	128GB	No	No	No	Support	Support	0	0	1	1	512GB
6548N	2	2	1	0	128GB	No	No	No	Support	Support	2	2	1	1	512GB
6548Y+	1	1	1	1	128GB	No	No	Support	No	Support	2	2	1	1	512GB
6554S	4	4	4	0	128GB	No	Support	No	No	Support	4	4	4	4	512GB
6558Q	0	0	1	0	128GB	No	No	No	Support	Support	0	0	1	1	512GB
8558	0	0	1	0	512GB	No	Support	No	No	No	0	0	4	4	512GB
8558P	1	1	1	1	512GB	No	Support	No	No	No	1	1	4	4	512GB
8558U	0	0	1	0	512GB	No	Support	No	No	No	0	0	4	4	512GB
8562Y+	1	1	1	1	512GB	No	No	Support	No	No	2	2	1	1	512GB
8568Y+	1	1	1	1	512GB	Support	Support	No	No	No	4	4	4	4	512GB
8570	0	0	1	0	512GB	No	Support	No	No	No	0	0	4	4	512GB
8571N	4	4	4	4	512GB	No	No	No	No	No	4	4	4	0	512GB
8580	0	0	1	0	512GB	No	Support	No	No	No	0	0	4	4	512GB
8581V	1	1	1	1	512GB	No	Support	No	No	No	1	1	4	4	512GB
8592+	1	1	1	1	512GB	Support	Support	No	No	No	4	4	4	4	512GB
8592V	1	1	1	1	512GB	No	Support	No	No	No	1	1	4	4	512GB
8593Q	1	1	1	1	512GB	No	Support	No	No	No	1	1	4	4	512GB

The following table lists the 4th Gen processors that support Intel on Demand. The table shows the default accelerators and default SGX Enclave size, and it shows (with green highlight) what the total new accelerators and SGX Enclave would be once the Intel On Demand features have been activated.

Table 22. Intel On Demand support by processor - 4th Gen processors

CPU model	Default accelerators and SGX Enclave					Intel On Demand upgrades					New accelerator quantities and SGX Enclave after applying Intel On Demand				
	QAT	DLB	DSA	IAA	SGX Enclv	BX9C	BX9D	BX9A	BX9B	BX9E	Green = additional accelerators/enclave added				
						CSS4 (4xQAT, 4xDLB, 4xDSA)	AS4 (4xDSA, 4xIAA)	CSS2 (2xQAT, 2xDLB)	AS1 (1xIAA)	SGX512	QAT	DLB	DSA	IAA	SGX Enclv
3408U	0	0	1	0	64GB	Processor 3408U does not support Intel on Demand									
4410T	0	0	1	0	64GB	No	No	No	Support	Support	0	0	1	1	512GB
4410Y	0	0	1	0	64GB	No	No	No	Support	Support	0	0	1	1	512GB
4416+	1	1	1	1	64GB	No	No	Support	No	Support	2	2	1	1	512GB
5411N	2	2	1	0	128GB	No	No	No	Support	Support	2	2	1	1	512GB
5412U	0	0	1	0	128GB	No	No	No	Support	Support	0	0	1	1	512GB
5415+	1	1	1	1	128GB	No	No	Support	No	Support	2	2	1	1	512GB
5416S	2	2	1	0	128GB	No	No	No	Support	Support	2	2	1	1	512GB
5418N	2	2	1	0	128GB	No	No	No	Support	Support	2	2	1	1	512GB
5418Y	0	0	1	0	128GB	No	No	No	Support	Support	0	0	1	1	512GB
5420+	1	1	1	1	128GB	No	No	Support	No	Support	2	2	1	1	512GB
5423N	0	0	1	0	128GB	No	No	No	No	Support	0	0	1	0	512GB
5433N	0	0	1	0	128GB	No	No	No	No	Support	0	0	1	0	512GB
6403N	0	0	1	0	128GB	No	No	No	No	Support	0	0	1	0	512GB
6414U	0	0	1	0	128GB	No	Support	No	No	Support	0	0	4	4	512GB
6416H	0	0	1	1	512GB	Processor 6416H does not support Intel on Demand									
6418H	0	0	1	1	512GB	Processor 6418H does not support Intel on Demand									
6421N	0	0	1	0	128GB	No	No	No	Support	Support	0	0	1	1	512GB
6423N	0	0	1	0	128GB	No	No	No	No	Support	0	0	1	0	512GB
6426Y	0	0	1	0	128GB	No	No	No	Support	Support	0	0	1	1	512GB
6428N	2	2	1	0	128GB	No	No	No	Support	Support	2	2	1	1	512GB
6430	0	0	1	0	128GB	No	Support	No	No	Support	0	0	4	4	512GB
6433N	0	0	1	0	128GB	No	No	No	No	Support	0	0	1	0	512GB
6434	0	0	1	0	128GB	No	No	No	Support	Support	0	0	1	1	512GB
6434H	0	0	1	1	512GB	Processor 6434H does not support Intel on Demand									
6438M	0	0	1	1	128GB	No	No	No	No	Support	0	0	1	1	512GB
6438N	2	2	1	0	128GB	No	No	No	Support	Support	2	2	1	1	512GB
6438Y+	1	1	1	1	128GB	No	No	Support	No	Support	2	2	1	1	512GB
6442Y	0	0	1	0	128GB	No	No	No	Support	Support	0	0	1	1	512GB
6443N	0	0	1	0	128GB	No	No	No	No	Support	0	0	1	0	512GB
6444Y	0	0	1	0	128GB	No	No	No	Support	Support	0	0	1	1	512GB
6448H	2	2	1	1	512GB	Processor 6448H does not support Intel on Demand									
6448Y	0	0	1	0	128GB	No	No	No	Support	Support	0	0	1	1	512GB
6454S	4	4	4	0	128GB	No	No	No	No	Support	4	4	4	0	512GB
6458Q	0	0	1	0	128GB	No	No	No	Support	Support	0	0	1	1	512GB
8444H	0	0	4	4	512GB	Processor 8444H does not support Intel on Demand									
8450H	0	0	4	4	512GB	Processor 8450H does not support Intel on Demand									
8452Y	0	0	1	0	128GB	No	Support	No	No	Support	0	0	4	4	512GB
8454H	4	4	4	4	512GB	Processor 8454H does not support Intel on Demand									
8458P	1	1	1	1	512GB	No	Support	No	No	No	1	1	4	4	512GB

CPU model	Default accelerators and SGX Enclave					Intel On Demand upgrades					New accelerator quantities and SGX Enclave after applying Intel On Demand				
	QAT	DLB	DSA	IAA	SGX Enclv	BX9C	BX9D	BX9A	BX9B	BX9E	Green = additional accelerators/enclave added				
						CSS4 (4xQAT, 4xDLB, 4xDSA)	AS4 (4xDSA, 4xIAA)	CSS2 (2xQAT, 2xDLB)	AS1 (1xIAA)	SGX512	QAT	DLB	DSA	IAA	SGX Enclv
8460H	0	0	4	4	512GB	Processor 8460H does not support Intel on Demand									
8460Y+	1	1	1	1	128GB	Support	Support	No	No	Support	4	4	4	4	512GB
8461V	1	1	1	1	128GB	No	Support	No	No	Support	1	1	4	4	512GB
8462Y+	1	1	1	1	128GB	No	No	Support	No	Support	2	2	1	1	512GB
8468	0	0	1	0	512GB	No	Support	No	No	No	0	0	4	4	512GB
8468H	4	4	4	4	512GB	Processor 8468H does not support Intel on Demand									
8468V	1	1	1	1	128GB	No	Support	No	No	Support	1	1	4	4	512GB
8470	0	0	1	0	512GB	No	Support	No	No	No	0	0	4	4	512GB
8470N	4	4	4	0	128GB	No	No	No	No	Support	4	4	4	0	512GB
8470Q	0	0	1	0	512GB	No	Support	No	No	No	0	0	4	4	512GB
8471N	4	4	4	0	128GB	No	No	No	No	Support	4	4	4	0	512GB
8480+	1	1	1	1	512GB	Support	Support	No	No	No	4	4	4	4	512GB
8480CL	1	1	1	1	512GB	No	Support	No	No	No	1	1	4	4	512GB
8490H	4	4	4	4	512GB	Processor 8490H does not support Intel on Demand									

Configuration rules:

- Not all processors support Intel On Demand upgrades - see the table for those that do not support Intel On Demand
- Upgrades can be performed in the factory (feature codes) or in the field (part numbers) but not both, and only one time
- Upgrades cannot be removed once activated
- SGX Enclave upgrades are independent of the accelerator upgrades; install either or both as desired
- For processors that support more than one upgrade, all upgrades must be performed at the same time
- Only one of each type of upgrade can be applied to a processor (eg 2x BX9A is not supported; 4x BX9B is not supported)
- The following processors support two accelerator upgrades, Intel On Demand Analytics Suite 4 (4L47A89452) and Intel On Demand Communications & Storage Suite 4 (4L47A89451); the table(s) above shows the accelerators based on both upgrades being applied.
 - Intel Xeon Platinum 8460Y+
 - Intel Xeon Platinum 8480+
 - Intel Xeon Platinum 8568Y+
 - Intel Xeon Platinum 8592+
- The number of accelerators listed for each upgrade is the number of accelerators that will be active one the upgrade is complete (ie the total number, not the number to be added)
- If a server has two processors, then two feature codes must be selected, one for each processor. The upgrades on the two processors must be identical.
- If a one-processor server with Intel On Demand features activated on it has a 2nd processor added as a field upgrade, the 2nd processor must also have the same features activated by purchasing the appropriate part numbers.

One-processor configurations

The SR650 V3 can be used with only one processor installed. Most core functions of the server (including the XClarity Controller) are connected to processor 1 as shown in the [System architecture](#) section.

With only one processor, the server has the following capabilities:

- 16 memory DIMMs for a 4TB maximum
- Rear slots: Slot 1-3 (riser 1) and slots 7-8 (riser 3) are available; (Slots 4-6 in Riser 2 are not available)
- Front slots: Slot 12 (Slot 11 is not available)

Drive support is as follows (see the [Storage configurations](#) section for specifics):

- Front SAS/SATA drives are supported - 8, 16, 24 drives (2.5-inch) or 8, 12 drives (3.5-inch)
- Front NVMe drives are supported - up to 8 drives (2.5-inch) or 4 drives (3.5-inch)
- Rear SAS/SATA drives are supported - 4x 3.5-inch drives or up to 4x 2.5-inch drives
- M.2 drives are supported
- 7mm rear drives are supported

Controller support is as follows:

- 12x onboard SATA
- 12x NVMe (8x onboard + 1x 4-port retimer adapter)
- RAID adapters/HBAs installed in slots 1-3
- Internal RAID/HBA controller (CFF form factor) with SAS/SATA-only configurations

Riser 3 is supported under the following conditions:

- No onboard NVMe connections are available
- With the x8/x8 PCIe Riser3 (BPKH or BPKF) selected, Slots 7 and 8 are both connected each with x8 lanes
- With the x16/x16 PCIe Riser3 (BLL9 or BPKG) selected, Slot 7 is connected with x16 lanes; Slot 8 is not connected
- The processor selected is not one of the following vRAN processors (insufficient PCIe lanes): 5423N, 5433N, 6403N, 6423N, 6433N, 6443N

The following components are not supported:

- Middle NVMe drive bays are not supported (SAS/SATA is supported)
- Rear 4x 3.5-inch drive bay backplane (this backplane gets power from Riser 2 which requires CPU 2)

Thermal requirements for processors

For thermal requirements for processors, see the Thermal Rules section in the Information Center for the SR650 V3:

https://pubs.lenovo.com/sr650-v3/thermal_rules

Lenovo Processor Neptune Core Module - Open-loop liquid cooling

The SR650 V3 also supports advanced direct-water cooling (DWC) capability with the Lenovo Processor Neptune Core Module. This module implements a liquid cooling solution where heat from the processors is removed from the rack and the data center using an open loop and coolant distribution units.

With the Processor Neptune Core Module, all heat generated by the processors is removed from the server using water. This means that the server fans and data center air conditioning units only need to remove the heat generated by the other components. This results in lower air conditioning costs and it enables the use of slower fans which results in lower overall power consumption.

Typical power saving of 23% (up to 9.9KW per rack) are possible, based on 18x SR650 V3 servers in a rack (DC level PUE weighted) at 30°C ambient temperature. Power savings are configuration dependent.

The following figure shows the Lenovo Processor Neptune Core Module.

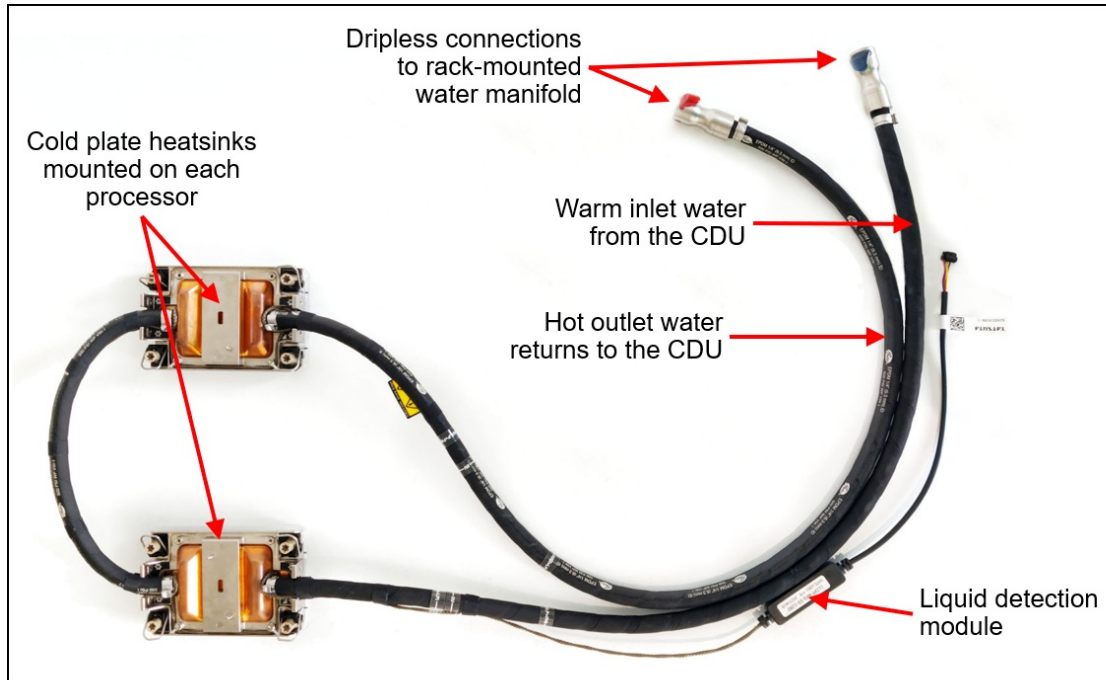

Figure 7. Lenovo Processor Neptune Core Module

The Processor Neptune Core Module also includes a leak detection module which can detect a leakage of more than 0.5ml (about 10 drops) along the length of the tube and then issue an event to the XClarity Controller. XCC will then post an error to the System Event Log and enable further actions. Once the liquid evaporates, a further event is issue to XCC.

The Processor Neptune Core Module is only available in CTO orders, not as a field upgrade. Ordering information is listed in the following table.

Table 23. Ordering information

Part number	Feature code	Description
CTO only	BXBC*	ThinkSystem V3 1U/2U Neptune Processor Direct Water Cooling Solution

* In DCSC, this feature code is listed in the Processor tab

Configuration notes:

- The Processor Neptune Core Module requires water infrastructure be available in the rack cabinet and data center, as described in the [Water infrastructure](#) section.
- All processor SKUs are supported
- Either one or two CPUs are supported
- All front drive bay configurations are supported
- Slot 6 is not available for adapters - the water loop is routed through the space otherwise occupied by slot 6
- Rear drive bays are supported
- 7mm drive bays are supported only in slot 3
- M.2 adapters are supported based on the configurations in the [Storage configurations](#) section
- Standard fans can be configured in most configurations
- The use of a cable management arm (CMA) is not supported

For more information, see the Thermal Rules page:
https://pubs.lenovo.com/sr650-v3/thermal_rules

The following figure shows the Lenovo Neptune Processor DWC Module installed in the SR650 V3 (risers removed to show internal components).

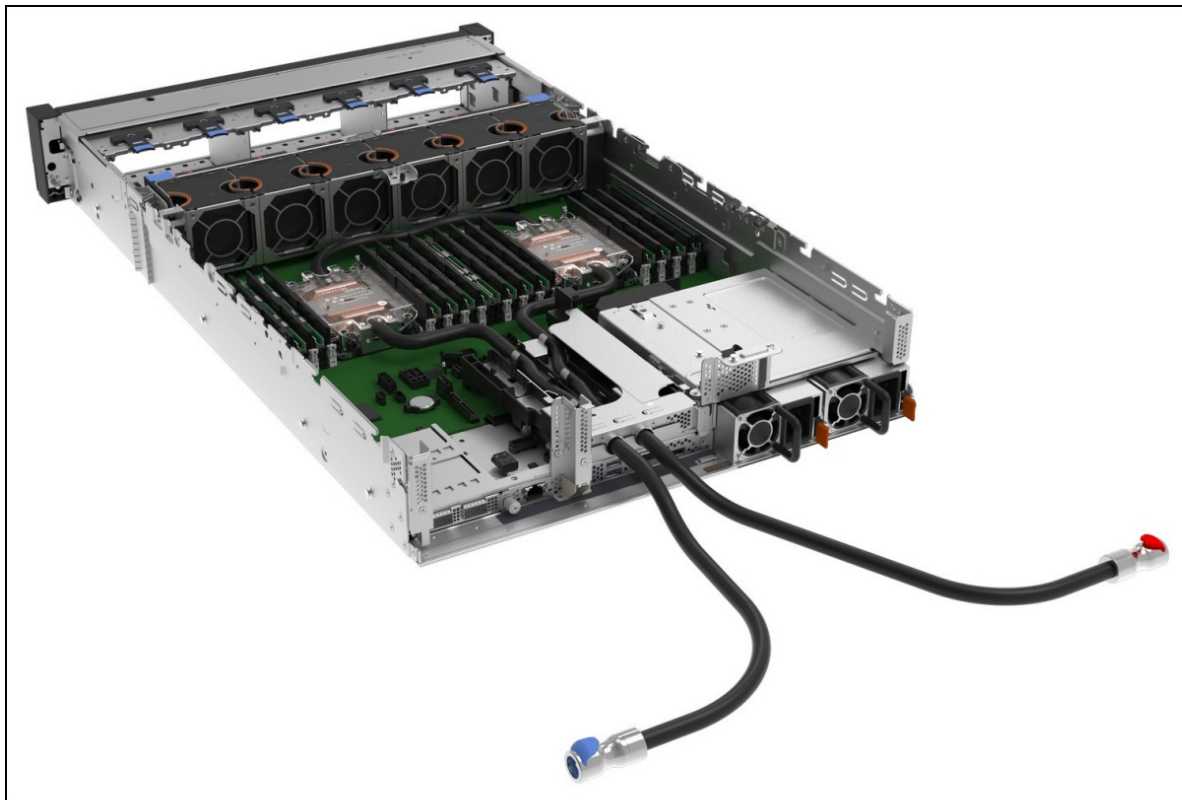

Figure 8. Lenovo Neptune Processor DWC Module installed in the SR650 V3

UEFI operating modes

The SR650 V3 offers preset operating modes that affect energy consumption and performance. These modes are a collection of predefined low-level UEFI settings that simplify the task of tuning the server to suit your business and workload requirements.

The following table lists the feature codes that allow you to specify the mode you wish to preset in the factory for CTO orders.

UK and EU customers: For compliance with the ERP Lot9 regulation, you should select feature BFYE. For some systems, you may not be able to make a selection, in which case, it will be automatically derived by the configurator.

Table 24. UEFI operating mode presets in DCSC

Feature code	Description
BFYB	Operating mode selection for: "Maximum Performance Mode"
BFYC	Operating mode selection for: "Minimal Power Mode"
BFYD	Operating mode selection for: "Efficiency Favoring Power Savings Mode"
BFYE	Operating mode selection for: "Efficiency - Favoring Performance Mode"

The preset modes for the SR650 V3 are as follows:

- **Maximum Performance Mode** (feature BFYB): Achieves maximum performance but with higher power consumption and lower energy efficiency.
- **Minimal Power Mode** (feature BFYC): Minimize the absolute power consumption of the system.
- **Efficiency Favoring Power Savings Mode** (feature BFYD): Maximize the performance/watt efficiency with a bias towards power savings. This is the favored mode for SPECpower benchmark testing, for example.
- **Efficiency Favoring Performance Mode** (feature BFYE): Maximize the performance/watt efficiency with a bias towards performance. This is the favored mode for Energy Star certification, for example.

For details about these preset modes, and all other performance and power efficiency UEFI settings offered in the SR650 V3, see the paper "Tuning UEFI Settings for Performance and Energy Efficiency on Intel Xeon Scalable Processor-Based ThinkSystem Servers", available from <https://lenovopress.lenovo.com/lp1477>.

Memory options

The SR650 V3 uses Lenovo TruDDR5 memory operating at up to 5600 MHz. The server supports up to 32 DIMMs with 2 processors. The processors have 8 memory channels and support 2 DIMMs per channel (DPC). The server supports up to 8TB of memory using 32x 256GB 3DS RDIMMs and two processors.

With 5th Gen Intel Xeon processors, DIMMs operate at the following speeds, up to the memory bus speed of the processor selected. See the [Processor features](#) section for specifics.

- 1 DIMM per channel (DPC) using RDIMMs: Up to 5600 MHz
- 1 DPC using 3DS RDIMMs: Up to 5200 MHz
- 2 DPC using RDIMMs or 3DS RDIMMs: Up to 4400 MHz
- 2 DPC using Performance+ RDIMMs: Up to 4800 MHz

With 4th Gen Intel Xeon processors, DIMMs operate at the following speeds, up to the memory bus speed of the processor selected:

- 1 DPC: Up to 4800 MHz
- 2 DPC: Up to 4400 MHz

Lenovo TruDDR5 memory uses the highest quality components that are sourced from Tier 1 DRAM suppliers and only memory that meets the strict requirements of Lenovo is selected. It is compatibility tested and tuned to maximize performance and reliability. From a service and support standpoint, Lenovo TruDDR5 memory automatically assumes the system warranty, and Lenovo provides service and support worldwide.

The following table lists the 5600 MHz memory options that are currently supported by the SR650 V3. These DIMMs are only supported with 5th Gen Intel Xeon processors, except the four specific 5th Gen processors listed in the memory rules below.

Table 25. 5600 MHz memory options

Part number	Feature code	Description	DRAM technology
Performance+ - 5600 MHz			
4X77A90991	BZ4U	ThinkSystem 32GB TruDDR5 Performance+ 5600MHz (2Rx8) RDIMM	16Gb
4X77A90992	BZ4V	ThinkSystem 64GB TruDDR5 Performance+ 5600MHz (2Rx4) RDIMM	16Gb
10x4 RDIMMs - 5600 MHz			
4X77A88049	BWHW	ThinkSystem 32GB TruDDR5 5600MHz (1Rx4) RDIMM	16Gb
4X77A88052	BWHS	ThinkSystem 64GB TruDDR5 5600MHz (2Rx4) RDIMM	16Gb
4X77A88639	BX8Y	ThinkSystem 48GB TruDDR5 5600MHz (1Rx4) RDIMM	24Gb
4X77A88058	BWHV	ThinkSystem 96GB TruDDR5 5600MHz (2Rx4) RDIMM	24Gb
x8 RDIMMs - 5600 MHz			
4X77A88087	BWJE	ThinkSystem 16GB TruDDR5 5600MHz (1Rx8) RDIMM	16Gb
4X77A88051	BWJC	ThinkSystem 32GB TruDDR5 5600MHz (2Rx8) RDIMM	16Gb
4X77A88056	BWSL	ThinkSystem 24GB TruDDR5 5600MHz (1Rx8) RDIMM	24Gb
4X77A88057	BWJD	ThinkSystem 48GB TruDDR5 5600MHz (2Rx8) RDIMM	24Gb
3DS RDIMMs - 5600 MHz			
4X77A88054	BWHU	ThinkSystem 128GB TruDDR5 5600MHz (4Rx4) 3DS RDIMM	16Gb

The following table lists the 4800 MHz memory options that are currently supported by the SR650 V3. These DIMMs are only supported with 4th Gen Intel Xeon processors plus four specific 5th Gen processors as listed in the memory rules below.

Table 26. 4800 MHz memory options

Part number	Feature code	Description	DRAM technology
9x4 RDIMMs - 4800 MHz			
4X77A77483	BNW5	ThinkSystem 32GB TruDDR5 4800MHz (1Rx4) 9x4 RDIMM	16Gb
4X77A77033	BKTN	ThinkSystem 64GB TruDDR5 4800MHz (2Rx4) 9x4 RDIMM	16Gb
10x4 RDIMMs - 4800 MHz			
4X77A77030	BNF6	ThinkSystem 32GB TruDDR5 4800MHz (1Rx4) 10x4 RDIMM	16Gb
4X77A77032	BNF9	ThinkSystem 64GB TruDDR5 4800MHz (2Rx4) 10x4 RDIMM	16Gb
4X77A87034	BZC2	ThinkSystem 96GB TruDDR5 4800MHz (2Rx4) RDIMM	24Gb
x8 RDIMMs - 4800 MHz			
4X77A77029	BKTL	ThinkSystem 16GB TruDDR5 4800MHz (1Rx8) RDIMM	16Gb
4X77A77031	BKTM	ThinkSystem 32GB TruDDR5 4800MHz (2Rx8) RDIMM	16Gb
4X77A87033	C1HB	ThinkSystem 48GB TruDDR5 4800MHz (2Rx8) RDIMM	24Gb
3DS RDIMMs - 4800 MHz			
4X77A77034	BNFC	ThinkSystem 128GB TruDDR5 4800MHz (4Rx4) 3DS RDIMM v2	16Gb
CTO only	BY8F	ThinkSystem 128GB TruDDR5 4800MHz (4Rx4) 3DS RDIMM v1	16Gb
CTO only	BZPM	ThinkSystem 256GB TruDDR5 4800MHz (8Rx4) 3DS RDIMM v1	16Gb
4X77A77035	BNF8	ThinkSystem 256GB TruDDR5 4800MHz (8Rx4) 3DS RDIMM v2	16Gb

9x4 RDIMMs (also known as EC4 RDIMMs) are a new lower-cost DDR5 memory option supported in ThinkSystem V3 servers. 9x4 DIMMs offer the same performance as standard RDIMMs (known as 10x4 or EC8 modules), however they support lower fault-tolerance characteristics. Standard RDIMMs and 3DS RDIMMs support two 40-bit subchannels (that is, a total of 80 bits), whereas 9x4 RDIMMs support two 36-bit subchannels (a total of 72 bits). The extra bits in the subchannels allow standard RDIMMs and 3DS RDIMMs to support Single Device Data Correction (SDDC), however 9x4 RDIMMs do not support SDDC. Note, however, that all DDR5 DIMMs, including 9x4 RDIMMs, support Bounded Fault correction, which enables the server to correct most common types of DRAM failures.

For more information on DDR5 memory, see the Lenovo Press paper, *Introduction to DDR5 Memory*, available from <https://lenovopress.com/lp1618>.

The following rules apply when selecting the memory configuration:

- 4800 MHz memory is only supported with 4th Gen Intel Xeon Scalable processors. 5600 MHz memory is only supported with 5th Gen Intel Xeon Scalable processors, with only four exceptions as listed below.
- The exceptions to the above rule are the following 5th Gen processors, which only support 4800 MHz memory DIMMs:
 - Intel Xeon Bronze 3508U 8C 125W 2.1GHz Processor
 - Intel Xeon Silver 4509Y 8C 125W 2.6GHz Processor
 - Intel Xeon Silver 4510 12C 150W 2.4GHz Processor
 - Intel Xeon Silver 4510T 12C 115W 2.0GHz Processor
- The SR650 V3 only supports quantities of 1, 2, 4, 6, 8, 12, or 16 DIMMs per processor; other quantities not supported. Additional quantity requirements:
 - 24GB and 48GB DIMMs are only supported in quantities 1, 6, 8 per processor (2, 4, 12, 16 not supported)
 - 96GB DIMMs are only supported in quantities 1, 6, 8, 12, 16 per processor (2, 4 not supported)

- The 48GB RDIMM (4X77A87033) and 96GB RDIMM (4X77A87034) are supported with all 5th Gen processors and only the following 4th Gen processors (XCC processors):
 - All 4th Gen Platinum processors except 8462Y+
 - Intel Xeon Gold 6414U 32C 250W 2.0GHz Processor
 - Intel Xeon Gold 6430 32C 270W 2.1GHz Processor
 - Intel Xeon Gold 6454S 32C 270W 2.2GHz Processor
- The server supports three types of DIMMs: 9x4 RDIMMs, RDIMMs, and 3DS RDIMMs; UDIMMs and LRDIMMs are not supported
- Mixing of DIMM types is not supported (9x4 DIMMs with 10x4 RDIMMs, 9x4 DIMMs with 3DS RDIMMs, 10x4 RDIMMs with 3DS RDIMMs)
- Mixing of DRAM technology (16Gb and 24Gb) is not supported. See the column in the above table.
- Mixing of 24GB, 48GB and 96GB DIMMs (24Gb DRAM) is not supported; if using any of these DIMMs then all installed memory must be the same part number
- Mixing x4 and x8 DIMMs is not supported
- Mixing of DIMM rank counts is supported. Follow the required installation order installing the DIMMs with the higher rank counts first.
- Mixing of DIMM capacities is supported, however only two different capacities are supported across all channels of the processor. Follow the required installation order installing the larger DIMMs first.
- Memory mirroring is not supported with 9x4 DIMMs
- The mixing of 128GB 3DS RDIMMs and 256GB 3DS RDIMMs is supported
- The use of the 128GB 3D RDIMM feature BY8F has the following requirements for thermal reasons:
 - If the front drive bays are 12x 3.5-inch, then middle and rear drive bays are not supported
 - Additional ambient temperature requirements - see https://pubs.lenovo.com/sr650-v3/thermal_rules for information

For best performance, consider the following:

- Ensure the memory installed is at least the same speed as the memory bus of the selected processor.
- Populate all 8 memory channels.

The following memory protection technologies are supported:

- ECC detection/correction
- Bounded Fault detection/correction
- SDDC (for 10x4-based memory DIMMs; look for "x4" in the DIMM description)
- ADDDC (for 10x4-based memory DIMMs, not supported with 9x4 DIMMs)
- Memory mirroring

See the Lenovo Press article "RAS Features of the Lenovo ThinkSystem Intel Servers" for more information about memory RAS features: <https://lenovopress.lenovo.com/lp1711-ras-features-of-the-lenovo-thinksystem-intel-servers>

If memory channel mirroring is used, then DIMMs must be installed in pairs (minimum of one pair per processor), and both DIMMs in the pair must be identical in type and size. 50% of the installed capacity is available to the operating system. Memory rank sparing is not supported.

Internal storage

The SR650 V3 has three drive bay zones and supports up to 20x 3.5-inch or 40x 2.5-inch hot-swap drive bays or a combination of drive bays, depending on the selected chassis and backplane configuration. The server also supports configurations without any drive bays if desired.

The three drive bay zones are as follows:

- Front:
 - Up to 12x 3.5-inch hot-swap bays, or
 - Up to 24x 2.5-inch hot-swap bays
- Middle:
 - 4x 3.5-inch hot-swap bays, or
 - 8x 2.5-inch hot-swap bays
- Rear:
 - Up to 4x 3.5-inch hot-swap bays, or
 - Up to 8x 2.5-inch hot-swap bays
 - Also supports 2x 7mm hot-swap drives bays

All drives are hot-swap and are accessible from the front, from the rear, or from drive bays that are located in the middle of the server (accessible when you remove the top cover of the server).

The server also supports one or two M.2 drives, installed in an M.2 adapter internal to the server.

In this section:

- [NVMe drive support](#)
- [Front drive bays](#)
- [Mid drive bays](#)
- [Rear drive bays](#)
- [Storage configurations](#)
- [Field upgrades](#)
- [RAID flash power module \(supercap\) support](#)
- [7mm drives](#)
- [M.2 drives](#)
- [SED encryption key management with SKLM](#)

NVMe drive support

The SR650 V3 supports NVMe drives to maximize storage performance.

- Up to 36 NVMe drives in a 2.5-inch drive configuration, without oversubscription (that is, each x4 drive has a dedicated x4 (4 lanes) connection to the processor, either direct to the processor or via a retimer adapter)
 - Up to 24 installed in front bays
 - Up to 28 installed in the front and rear bays
 - Up to 32 installed in front and mid bays
 - Up to 36 installed in front, mid and rear bays
- Up to 8 NVMe drives in a 3.5-inch drive configuration, without oversubscription
 - All installed in mid bays

Riser 3 support: The use of the onboard NVMe ports is mutually exclusive with Riser 3, as these use the same PCIe connectors. See the [System architecture](#) section.

The specifics of these configurations are covered in the [Storage configurations](#) section. The tables in those sections indicate the number of NVMe drives in each configuration.

In addition, the SR650 V3 supports two 7mm NVMe drives for use as boot drives. These two drives optionally support RAID via Intel VROC.

The RAID 940-8i and RAID 940-16i adapters also support NVMe through a feature named Tri-Mode support (or Trimode support). This feature enables the use of NVMe U.3 drives at the same time as SAS and SATA drives. Tri-Mode requires an AnyBay backplane. Cabling of the controller to the backplanes is the same as with SAS/SATA drives, and the NVMe drives are connected via a PCIe x1 link to the controller.

NVMe drives connected using Tri-Mode support provide better performance than SAS or SATA drives: A SATA SSD has a data rate of 6Gbps, a SAS SSD has a data rate of 12Gbps, whereas an NVMe U.3 Gen 4 SSD with a PCIe x1 link will have a data rate of 16Gbps. NVMe drives typically also have lower latency and higher IOPS compared to SAS and SATA drives. Tri-Mode is supported with U.3 NVMe drives and requires an AnyBay backplane.

Tri-Mode requires U.3 drives: Only NVMe drives with a U.3 interface are supported. U.2 drives are not supported. See the [Internal drive options](#) section for the U.3 drives supported by the server.

Front drive bays

The front drive bay zone supports the following configurations:

- 8x or 12x 3.5-inch drive bays (all hot-swap)
- 8x, 16x or 24x 2.5-inch drive bays (all hot-swap)
- 4x 2.5-inch drive bays (all hot-swap) with support for front PCIe slots
- No backplanes and no drives (supports [field upgrades](#))

The specific combinations that are supported in the SR650 V3 are shown in the following figures. The feature codes listed are the backplane feature codes when ordering CTO and correspond to the feature codes listed in the table below the figure. Note that NVMe and AnyBay backplanes may be available either PCIe Gen4 (G4) or PCIe Gen5 (G5) as listed in the figures.

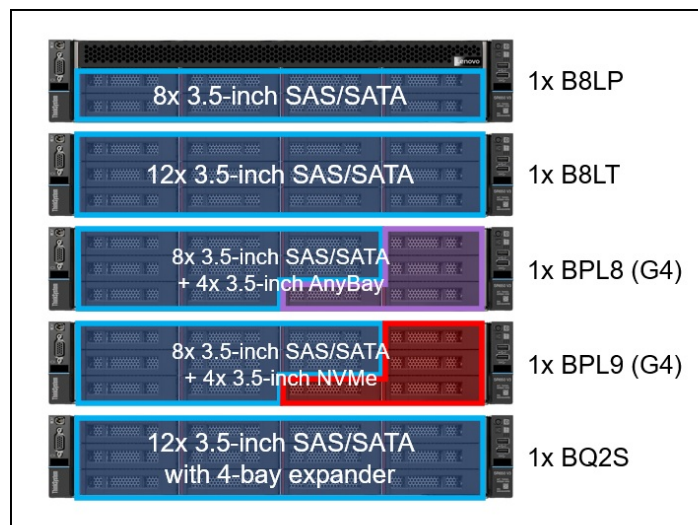

Figure 9. SR650 V3 front drive bay configurations - 3.5-inch drive bays

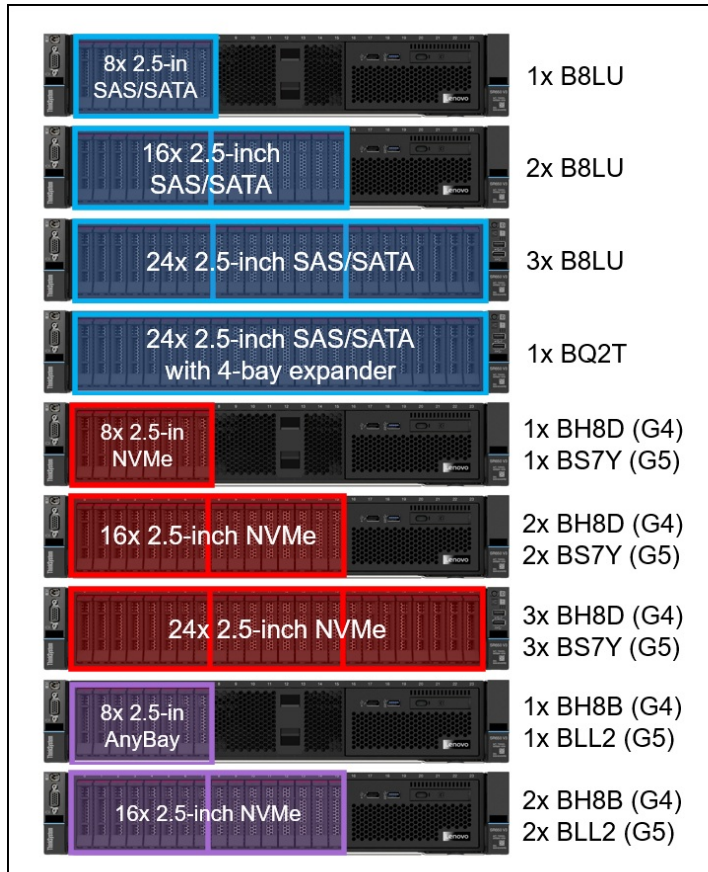

Figure 10. SR650 V3 front drive bay configurations - 2.5-inch drive bays, all the same drive type

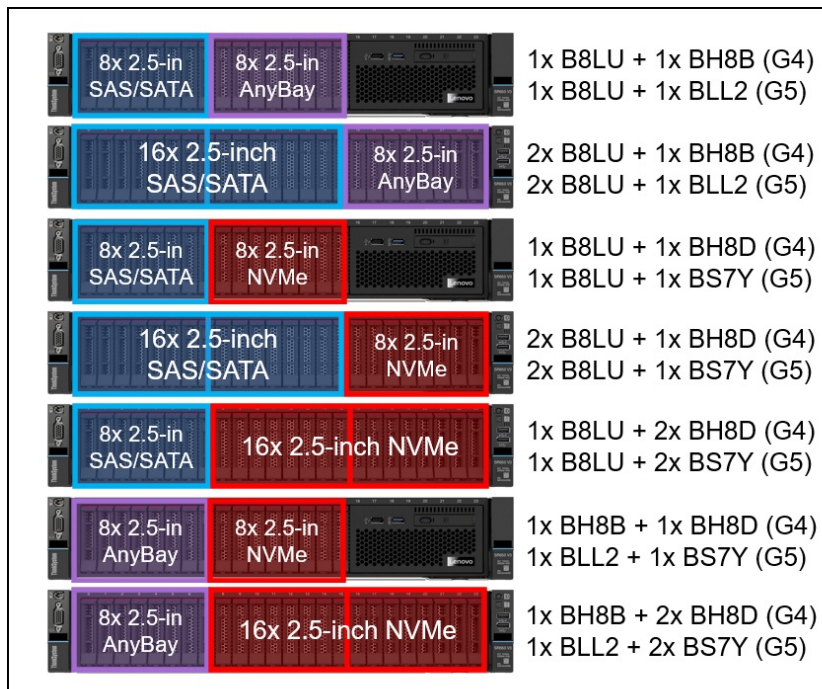

Figure 11. SR650 V3 front drive bay configurations - 2.5-inch drive bays, combinations

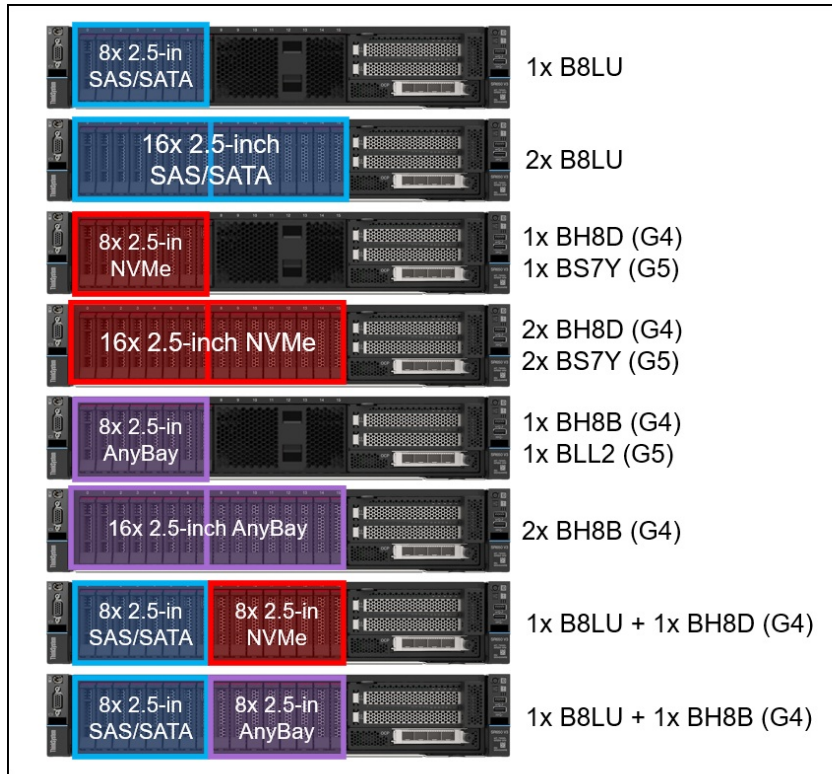

Figure 12. SR650 V3 front drive bay configurations - 2.5-inch drive bays with front PCIe slots

The backplanes used to provide these drive bays are listed in the following table.

Field upgrades: All front backplanes are available as part numbers for field upgrades along with require cable option kits, as described in the [Field upgrades](#) section below.

Table 27. Backplanes for front drive bays

Feature	Description	Bays	PCIe Gen	Maximum supported
Front 3.5-inch drive backplanes				
B8LP	ThinkSystem 2U 8x3.5" SAS/SATA Backplane	8	-	1
B8LT	ThinkSystem 2U 12x3.5" SAS/SATA Backplane	12	-	1
BPL8	ThinkSystem 2U 8x3.5" SAS/SATA+4 AnyBay Backplane	12	Gen4	1
BPL9	ThinkSystem 2U 8x3.5" SAS/SATA+4 NVMe Backplane	12	Gen4	1
BQ2S	ThinkSystem 2U 12x3.5" SAS/SATA with Rear 4-Bay Expander Backplane	12*	-	1
Front 2.5-inch drive backplanes				
B8LU	ThinkSystem 2U 8x2.5" SAS/SATA Backplane	8	-	3
BH8D	ThinkSystem 2U/4U 8x2.5" NVMe Backplane	8	Gen4	3
BS7Y	ThinkSystem V3 2U 8x2.5" NVMe Gen5 Backplane	8	Gen5	3
BH8B	ThinkSystem 2U/4U 8x2.5" AnyBay Backplane	8	Gen4	3
BLL2	ThinkSystem V3 2U 8x2.5" AnyBay Gen5 Backplane	8	Gen5	3
BQ2T	ThinkSystem 2U 24x2.5" SAS/SATA with Rear 4-Bay Expander Backplane	24*	-	1
Integrated Diagnostics Panel (for 2.5-inch configurations with 8 or 16 bays only)				
BMJA	ThinkSystem 2U 16x2.5" Front Operator Panel v2	-	-	1

* Backplane has an onboard SAS expander that provides connectivity to front SAS/SATA drive bays using only an 8-port controller, plus support for 4x rear drives in a separate backplane (order the rear backplane separately). See below for additional information and requirements.

The use of front drive bays has the following configuration rules:

- The SR650 V3 also supports configurations without any drive bays, allowing for drive bay upgrades as described in the [field upgrades](#) section.
- Most backplanes require connections to controllers that provides enough ports to connect each drive (eg 8 ports for an 8-bay backplane). The only exceptions to that are the backplanes with built-in SAS expanders - these backplanes require a fewer number of controller ports to connect to the front drives, and also include a connection to up to 4x rear drive bays. Connections to mid-chassis backplanes or to 8x rear drive bays require additional controller ports. Supported connections are as follows:
 - For the ThinkSystem 2U 12x3.5" SAS/SATA with Rear 4-Bay Expander Backplane, feature BQ2S:
 - 12x3.5" front drives only: requires a single 8i controller
 - 12x3.5" + 4x3.5" (Rear): requires a single 8i controller, 8i to front+rear
 - 12x3.5" + 4x3.5" (Mid): requires 16i controller - 8i to front, 8i to middle
 - 12x3.5" + 4x3.5" (Mid) + 4x3.5" (Rear): requires 16i controller, 8i to front+rear, 8i to middle
 - For the ThinkSystem 2U 24x2.5" SAS/SATA with Rear 4-Bay Expander Backplane, feature BQ2T:
 - 24x2.5" front drives only: requires a single 8i controller
 - 24x2.5" + 4x2.5" (Rear): requires a single 8i controller, 8i to front+rear
 - 24x2.5" + 8x2.5" (Mid): requires 16i controller - 8i to front, 8i to middle
 - 24x2.5" + 8x2.5" (Mid) + 8x2.5" (Rear): requires 32i controller - 8i to front, 8i to middle, 8i to rear

For specifics configurations, see the [Storage configurations](#) section.

- If you are building a server configuration that includes the ThinkSystem 2U 24x2.5" SAS/SATA with Rear 4-Bay Expander Backplane (feature BQ2T) and the order also includes a rack cabinet, then you can configure at most 6 drives to be installed in the factory. The remaining drives must be ordered separately using the option part numbers for the drives. This requirement does not apply if the order does not include a rack cabinet. The requirement is due to the shock/vibration limits of the 24x 2.5-inch backplane.
- If 3.5-inch front drive bays are used, an internal (CFF) RAID adapter or HBA is not supported as the adapter and bays occupy the same physical space
- Any 8x 2.5-inch and 16x 2.5-inch drive configuration (SAS/SATA, AnyBay, or NVMe) can optionally be configured for use with the Integrated Diagnostics Panel as described in the [Local management](#) section. 3.5-inch drive configurations do not support the Integrated Diagnostics Panel. With the Integrated Diagnostics Display, 8-bay configurations can be upgrade to 16 bays, however 16-bay configurations cannot be upgrade to 24 bays.

Mid drive bays

The SR650 V3 supports hot-swap drives installed in the middle of the server chassis. The drive bays are accessible by removing the top lid of the server and levering the mid drive chassis up at the front.

The following configurations are supported:

- 4x 3.5-inch hot-swap SAS/SATA drive bays
- 8x 2.5-inch hot-swap SAS/SATA drive bays
- 8x 2.5-inch hot-swap NVMe drive bays

The drive bays in the open position are shown in the following figure.

M.2 support: When mid drive bays are configured, the M.2 adapter is installed on the mid drive bay mechanical as shown in the images.

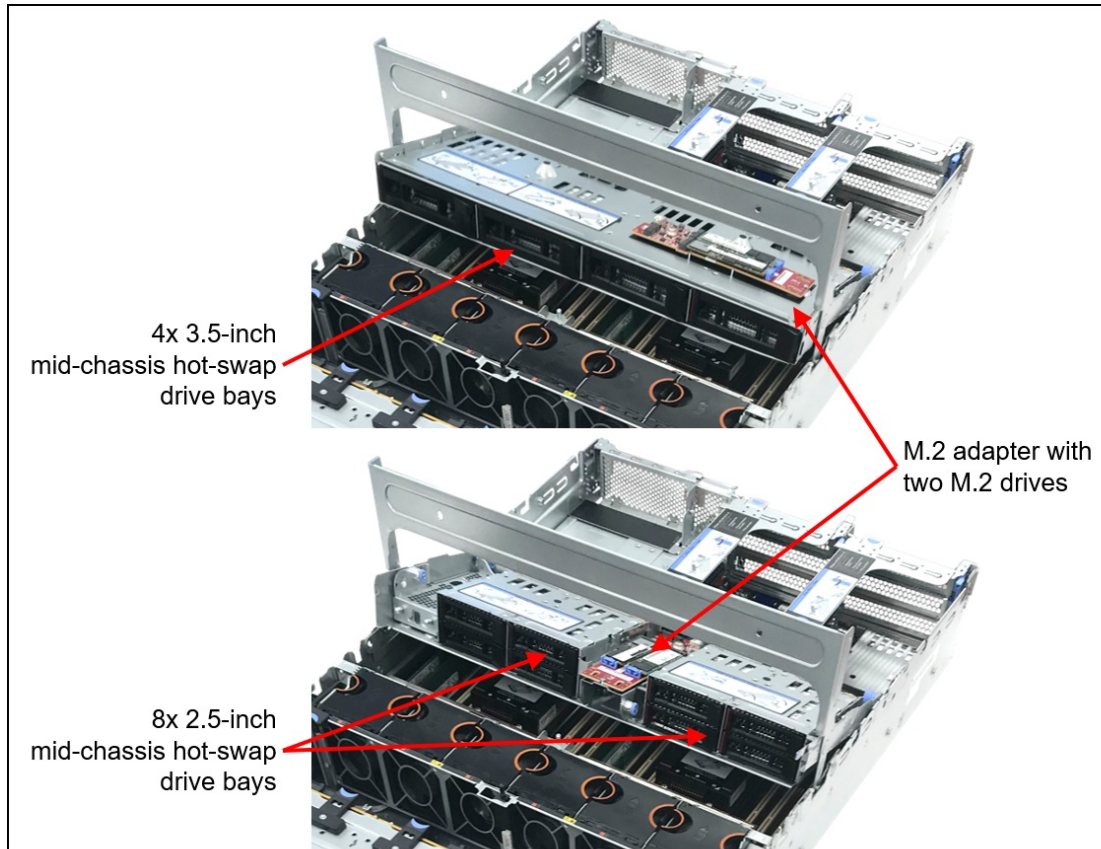

Figure 13. Mid-chassis drive bays

The backplanes used to provide these drive bays are listed in the following table.

Table 28. Backplanes for mid-chassis drive bays

Feature code	Description	PCIe Gen	Maximum supported
Mid - 3.5-inch drive backplane			
BCQK	ThinkSystem 2U 4x3.5" SAS/SATA Middle Backplane	-	1
Mid - 2.5-inch drive backplane			
BCQL	ThinkSystem 2U 4x2.5" SAS/SATA Middle Backplane	-	2‡
BDY7	ThinkSystem 2U 4x2.5" Middle NVMe Backplane	Gen4	2‡
BS81	ThinkSystem 2U 4x2.5" Middle NVMe Gen5 Backplane	Gen5	

‡ 2.5-inch drive backplanes for the mid-chassis area must be installed in pairs. NVMe and SAS/SATA cannot be mixed.

Field upgrades: Backplanes are available as part numbers for field upgrades along with require cable option kits, as described in the [Field upgrades](#) section below.

The use of drive bays in the mid-chassis area has the following configuration rules:

- All processors are supported. Higher TDP processors will require the performance heatsinks.
- Full-length adapter cards are not supported
- GPUs (including low profile GPUs such as the NVIDIA A2) are not supported
- The use of mid drive bays requires Riser 1 be installed, since power for the mid bay backplanes comes

from Riser 1

Rear drive bays

The SR650 V3 supports hot-swap drives installed at the rear of the server chassis. Supported configurations are as follows:

- 3.5-inch hot-swap drives
 - 2x SAS/SATA drive bays
 - 4x SAS/SATA drive bays
- 2.5-inch hot-swap drives
 - 4x SAS/SATA drive bays
 - 4x NVMe Gen5 drive bays
 - 4x AnyBay Gen5 drive bays
 - 8x SAS/SATA drive bays

The configurations are shown in the following figure.

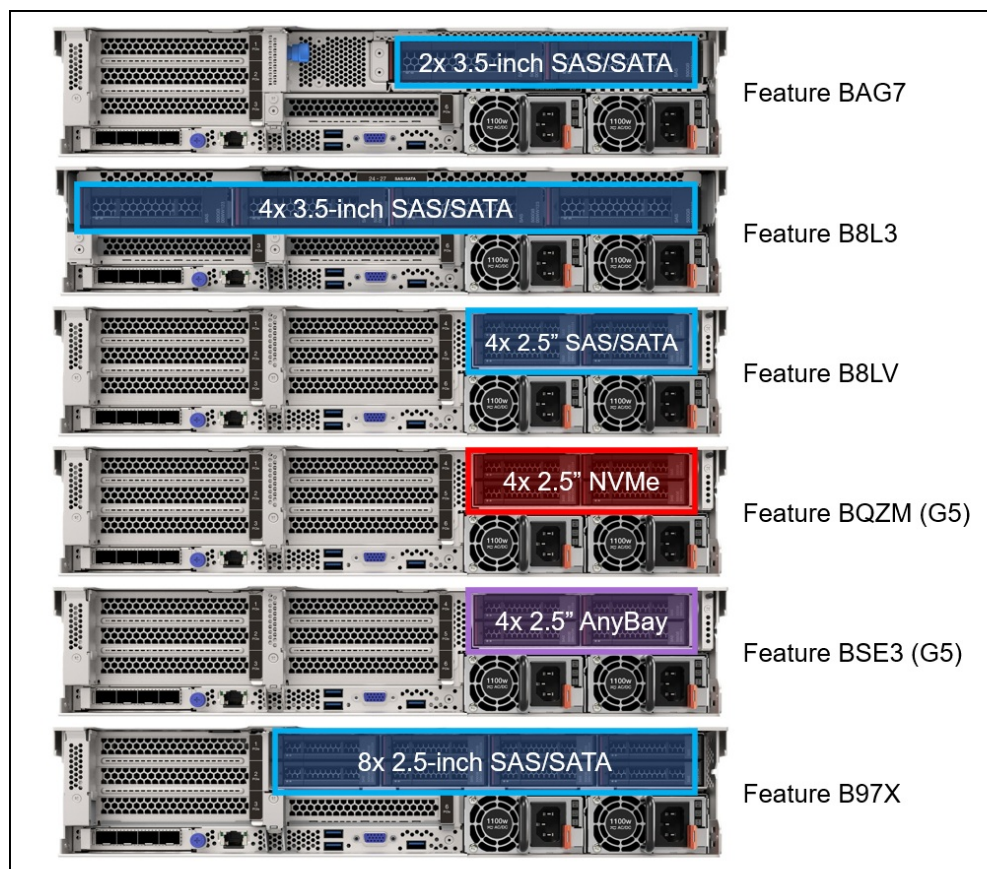

Figure 14. Rear 2.5-inch and 3.5-inch drive bay configurations

The backplanes used to provide these drive bays are listed in the following table.

7mm drives: The SR650 V3 supports two 7mm drives. See the [7mm drives](#) section for details.

Table 29. Backplanes for rear drive bays

Feature code	Description	PCIe Gen	Maximum supported
Rear - 3.5-inch drive backplanes			
BAG7	ThinkSystem 2U 2x3.5" SAS/SATA Rear Backplane	-	1
B8L3	ThinkSystem 1U/2U 4x3.5" SAS/SATA Backplane	-	1
Rear - 2.5-inch drive backplanes			
B8LV	ThinkSystem 2U 4x2.5" SAS/SATA Backplane	-	1
BQZM	ThinkSystem 4x2.5" NVMe Gen 5 Backplane	Gen5	
BSE3	ThinkSystem 4x2.5" AnyBay Gen5 Backplane	Gen5	1
B97X	ThinkSystem 2U 8x2.5" SAS/SATA Rear Backplane	-	1

Field upgrades: Backplanes are available as part numbers for field upgrades along with require cable option kits, as described in the [Field upgrades](#) section below.

The use of rear drive bays has the following configuration rules:

- The use of rear bays restricts the number of slots and the choice of risers that are supported. See the [I/O expansion](#) section for details.
- The use of rear drive bays may require that Riser 1 or Riser 2 be installed, since power for the rear backplane comes from that riser.
- Configurations with 4x 2.5-inch rear drive bays are not supported with 7mm drive bays, as they use the same power connector

Storage configurations

This section describes the various combinations of front and rear drives that the server supports, as well as M.2 support.

Tip: These tables are based on Config Matrix V4.6 in TRD V3.39

In this section:

- [Overview of configurations - 3.5-inch front drive bays](#)
- [Overview of configurations - 2.5-inch front drives supporting rear slots \(no front PCIe slots\)](#)
- [Overview of configurations - 2.5-inch front drives supporting 12 PCIe slots \(front & rear\)](#)
- [Details - 3.5-inch front drive bays](#)
- [Details - 2.5-inch front drives supporting rear slots \(no front PCIe slots\)](#)
- [Details - 2.5-inch front drives supporting 12 PCIe slots \(front & rear\)](#)

The following tables summarize the storage configurations for the SR650 V3. For details, including processor requirements, M.2 and 7mm support, and controller selections, see each of the Details tables.

Overview - 3.5-inch front drives

The following table summarizes the configurations that use 3.5-inch front drive bays.

Click to jump down to the [details of the 3.5-inch front drive configurations](#) .

Return to [Storage configurations](#).

Field upgrades: For part number upgrades, see the [Drive bays field upgrades - 3.5-inch chassis](#) section.

Table 30. Overview - 3.5-inch front drives

Config	Total drives (NVMe)	Front			Mid			Rear				Backplanes
		SAS/SATA	Any Bay	NVMe	3.5" SAS	2.5" SAS	2.5" NVMe	3.5" SAS	2.5" SAS	2.5" NVMe	2.5" Any	
1	8 (0)	8	0	0	0	0	0	0	0	0	0	8x3.5" SAS/SATA (B8LP)
2	12 (0)	12	0	0	0	0	0	0	0	0	0	12x3.5" SAS/SATA (B8LT)
3	14 (0)	12	0	0	0	0	0	2	0	0	0	Front: 12x3.5" SAS/SATA (B8LT); Rear: 2x3.5" SAS/SATA (BAG7)
4	16 (0)	12	0	0	0	0	0	4	0	0	0	Front: 12x3.5" SAS/SATA (B8LT); Rear: 4x3.5" SAS/SATA (B8L3)
5	16 (0)	12	0	0	0	0	0	0	4	0	0	Front: 12x3.5" SAS/SATA (B8LT); Rear: 4x2.5" SAS/SATA (B8LV)
6	20 (0)	12	0	0	4	0	0	4	0	0	0	Front: 12x3.5" SAS/SATA (B8LT); Mid: 4x3.5" SAS/SATA (BCQK); Rear: 4x3.5" SAS/SATA (B8L3)
6A	16 (0)	12	0	0	4	0	0	0	0	0	0	Front: 12x3.5" SAS/SATA (B8LT); Mid: 4x3.5" SAS/SATA (BCQK)
6B	16 (0)	12	0	0	0	4	0	0	0	0	0	Front: 12x3.5" SAS/SATA (B8LT); Mid: 4x2.5" SAS/SATA (BCQL)
7A	12 (4)	8	4	0	0	0	0	0	0	0	0	1x 8x3.5" SAS/SATA + 4x3.5" AnyBay G4 (BPL8)
7B	12 (4)	8	0	4	0	0	0	0	0	0	0	1x 8x3.5" SAS/SATA + 4x3.5" NVMe G4 (BPL9)
8A	16 (4)	8	4	0	0	0	0	4	0	0	0	Front: 1x 8x3.5" SAS/SATA + 4x3.5" AnyBay G4 (BPL8); Rear: 4x3.5" SAS/SATA (B8L3)
8B	16 (4)	8	0	4	0	0	0	4	0	0	0	Front: 1x 8x3.5" SAS/SATA + 4x3.5" NVMe G4 (BPL9); Rear: 4x3.5" SAS/SATA (B8L3)
26	20 (8)	12	0	0	0	0	8	0	0	0	0	Front: 12x3.5" SAS/SATA (B8LT); Mid: 2x 4x2.5" NVMe G4 (BDY7)
42	12 (0)	12	0	0	0	0	0	0	0	0	0	12x3.5" SAS/SATA with Expander (BQ2S)
43	16 (0)	12	0	0	0	0	0	4	0	0	0	Front: 12x3.5" SAS/SATA with Expander (BQ2S); Rear: 4x3.5" SAS/SATA (B8L3)
44	16 (4)	12	0	0	0	0	0	0	0	0	4	Front: 12x3.5" SAS/SATA with Expander (BQ2S); Rear: 4x 2.5" AnyBay G5 (BSE3)
45	14 (0)	12	0	0	0	0	0	2	0	0	0	Front: 12x3.5" SAS/SATA with Expander (BQ2S); Rear: 2x3.5" SAS/SATA (BAG7)
46	20 (0)	12	0	0	4	0	0	4	0	0	0	Front: 12x3.5" SAS/SATA with Expander (BQ2S); Mid: 4x3.5" SAS/SATA (BCQK); Rear: 4x3.5" SAS/SATA (B8L3)
54	16 (4)	12	0	0	0	0	0	0	0	0	4	Front: 12x3.5" SAS/SATA (B8LT); Rear: 4x 2.5" AnyBay G5 (BSE3)
99	20 (8)	12	0	0	0	0	8	0	0	0	0	Front: 12x3.5" SAS/SATA (B8LT); Mid: 2x 4x2.5" NVMe G5 (BS81)

Overview - 2.5-inch front drives supporting rear slots (no front PCIe slots)

The following table summarizes the configurations that use 2.5-inch front drives supporting rear slots (no front PCIe slots).

Click to jump down to the [details of the 2.5-inch front drive configurations](#) .

Return to [Storage configurations](#).

Field upgrades: For part number upgrades, see the following:

- [Drive bay field upgrades - 2.5-inch chassis with SAS/SATA and Gen4 front bays](#)
- [Drive bay field upgrades - 2.5-inch chassis with Gen5 front bays](#)

Table 31. Overview - 2.5-inch front drives supporting rear slots (no front PCIe slots)

Config	Total drives (NVMe)	Front			Mid			Rear				Backplanes
		SAS/SATA	Any Bay	NVMe	3.5" SAS	2.5" SAS	2.5" NVMe	3.5" SAS	2.5" SAS	2.5" NVMe	2.5" Any	
9	8 (0)	8	0	0	0	0	0	0	0	0	0	1x 8x2.5" SAS/SATA (B8LU)
10	8 (8)	0	8	0	0	0	0	0	0	0	0	1x 8x2.5" AnyBay G4 (BH8B)
11	8 (8)	0	0	8	0	0	0	0	0	0	0	1x 8x2.5" NVMe G4 (BH8D)
12	16 (0)	16	0	0	0	0	0	0	0	0	0	2x 8x2.5" SAS/SATA (B8LU)
13	16 (16)	0	8	8	0	0	0	0	0	0	0	8x2.5" NVMe G4 (BH8D) + 8x2.5" AnyBay G4 (BH8B)
14A	16 (16)	0	0	16	0	0	0	0	0	0	0	2x 8xNVMe G4 (BH8D)
14B	16 (16)	0	16	0	0	0	0	0	0	0	0	2x 8x2.5" AnyBay G4 (BH8B)
15	16 (8)	8	8	0	0	0	0	0	0	0	0	1x 8x2.5" SAS/SATA (B8LU) + 1x 8x2.5" AnyBay G4 (BH8B)
16	16 (8)	8	0	8	0	0	0	0	0	0	0	1x 8x2.5" SAS/SATA (B8LU) + 1x 8x2.5" NVMe G4 (BH8D)
17	24 (8)	16	8	0	0	0	0	0	0	0	0	2x 8x2.5" SAS/SATA (B8LU) + 1x 8x2.5" AnyBay G4 (BH8B)
18	24 (8)	16	0	8	0	0	0	0	0	0	0	2x 8x2.5" SAS/SATA (B8LU) + 1x 8x2.5" NVMe G4 (BH8D)
19A	24 (16)	8	0	16	0	0	0	0	0	0	0	1x 8x2.5" SAS/SATA (B8LU) + 2x 8x2.5" NVMe G4 (BH8D)
19B	24 (16)	8	16	0	0	0	0	0	0	0	0	1x 8x2.5" SAS/SATA (B8LU) + 2x 8xAnyBay G4 (BH8B)
20	24 (0)	24	0	0	0	0	0	0	0	0	0	3x 8x2.5" SAS/SATA (B8LU)
21A	24 (24)	0	0	24	0	0	0	0	0	0	0	3x 8xNVMe G4 (BH8D)
21B	24 (24)	0	24	0	0	0	0	0	0	0	0	3x 8x2.5" AnyBay G4 (BH8B)
21C	24 (24)	0	8	16	0	0	0	0	0	0	0	1x 8x2.5" AnyBay G4 (BH8B) + 2x 8x2.5" NVMe G4 (BH8D)
22	28 (8)	16	8	0	0	0	0	0	4	0	0	Front: 2x 8x2.5" SAS/SATA (B8LU) + 1x 8x2.5" AnyBay G4 (BH8B); Rear: 4x2.5" SAS/SATA (B8LV)
23	28 (0)	24	0	0	0	0	0	0	4	0	0	Front: 3x 8x2.5" SAS/SATA (B8LU); Rear: 4x2.5" SAS/SATA (B8LV)
23A	32 (0)	24	0	0	0	0	0	0	8	0	0	Front: 3x 8x2.5" SAS/SATA (B8LU); Rear: 8x2.5" SAS/SATA (B97X)
24	32 (32)	0	0	24	0	0	8	0	0	0	0	Front: 3x 8xNVMe G4 (BH8D); Mid: 2x 4x2.5" NVMe G4 (BDY7)
25	40 (0)	24	0	0	0	8	0	0	8	0	0	Front: 3x 8x2.5" SAS/SATA (B8LU); Mid: 2x 4x2.5" SAS/SATA (BCQL); Rear: 8x2.5" SAS/SATA (B97X)
25A	28 (0)	24	0	0	0	4	0	0	0	0	0	Front: 3x 8x2.5" SAS/SATA (B8LU); Mid: 4x2.5" SAS/SATA (BCQL)
25B	32 (0)	24	0	0	0	8	0	0	0	0	0	Front: 3x 8x2.5" SAS/SATA (B8LU); Mid: 2x 4x2.5" SAS/SATA (BCQL)
25C	36 (0)	24	0	0	0	8	0	0	4	0	0	Front: 3x 8x2.5" SAS/SATA (B8LU); Mid: 2x 4x2.5" SAS/SATA (BCQL); Rear: 4x2.5" SAS/SATA (B8LV)

Config	Total drives (NVMe)	Front			Mid			Rear				Backplanes
		SAS/SATA	Any Bay	NVMe	3.5" SAS	2.5" SAS	2.5" NVMe	3.5" SAS	2.5" SAS	2.5" NVMe	2.5" Any	
27	14 (0)	14	0	0	0	0	0	0	0	0	0	2x 8x2.5" SAS/SATA (B8LU) (14 bays max)
29A	16 (16)	0	16	0	0	0	0	0	0	0	0	2x 8x2.5" AnyBay G4 (BH8B)
29B	16 (16)	0	16	0	0	0	0	0	0	0	0	2x 8x2.5" AnyBay G4 (BH8B)
41	8 (8)	0	8	0	0	0	0	0	0	0	0	1x 8x2.5" AnyBay G4 (BH8B)
47	24 (0)	24	0	0	0	0	0	0	0	0	0	24x2.5" SAS/SATA with Expander (BQ2T)
48	28 (0)	24	0	0	0	0	0	0	4	0	0	Front: 24x2.5" SAS/SATA with Expander (BQ2T); Rear: 4x2.5" SAS/SATA (B8LV)
49	28 (4)	24	0	0	0	0	0	0	0	0	4	Front: 24x2.5" SAS/SATA with Expander (BQ2T); Rear: 4x 2.5" AnyBay G5 (BSE3)
50	32 (0)	24	0	0	0	0	0	0	8	0	0	Front: 24x2.5" SAS/SATA with Expander (BQ2T); Rear: 8x2.5" SAS/SATA (B97X)
51	28 (28)	0	0	24	0	0	0	0	0	4	0	Front: 3x 8xNVMe G4 (BH8D); Rear: 1x 4x2.5" NVMe G5 (BQZM)
52	36 (36)	0	0	24	0	0	8	0	0	4	0	Front: 3x 8xNVMe G4 (BH8D); Mid: 2x 4x2.5" NVMe G4 (BDY7); Rear: 1x 4x2.5" NVMe G5 (BQZM)
55	28 (4)	24	0	0	0	0	0	0	0	0	4	Front: 3x 8x2.5" SAS/SATA (B8LU); Rear: 4x 2.5" AnyBay G5 (BSE3)
60	8 (8)	0	8	0	0	0	0	0	0	0	0	1x 8x2.5" AnyBay G5 (BLL2)
61	8 (8)	0	0	8	0	0	0	0	0	0	0	1x 8x2.5" NVMe G5 (BS7Y)
62	16 (16)	0	8	8	0	0	0	0	0	0	0	1x 8x2.5" AnyBay G5 (BLL2) + 1x 8x2.5" NVMe G5 (BS7Y)
63	16 (16)	0	0	16	0	0	0	0	0	0	0	2x 8x2.5" NVMe G5 (BS7Y)
64	16 (8)	8	8	0	0	0	0	0	0	0	0	1x 8x2.5" SAS/SATA (B8LU) + 1x 8x2.5" AnyBay G5 (BLL2)
65	16 (8)	8	0	8	0	0	0	0	0	0	0	1x 8x2.5" SAS/SATA (B8LU) + 1x 8x2.5" NVMe G5 (BS7Y)
67	24 (8)	16	8	0	0	0	0	0	0	0	0	2x 8x2.5" SAS/SATA (B8LU) + 1x 8x2.5" AnyBay G5 (BLL2)
68	24 (8)	16	0	8	0	0	0	0	0	0	0	2x 8x2.5" SAS/SATA (B8LU) + 1x 8x2.5" NVMe G5 (BS7Y)
69	24 (16)	8	0	16	0	0	0	0	0	0	0	1x 8x2.5" SAS/SATA (B8LU) + 2x 8x2.5" NVMe G5 (BS7Y)
70	24 (24)	0	0	24	0	0	0	0	0	0	0	3x 8x2.5" NVMe G5 (BS7Y)
71	24 (24)	0	8	16	0	0	0	0	0	0	0	1x 8x2.5" AnyBay G5 (BLL2) + 2x 8x2.5" NVMe G5 (BS7Y)
72	28 (8)	16	8	0	0	0	0	0	4	0	0	Front: 2x 8x2.5" SAS/SATA (B8LU) + 1x 8x2.5" AnyBay G5 (BLL2); Rear: 4x2.5" SAS/SATA (B8LV)
75A	16 (16)	0	16	0	0	0	0	0	0	0	0	2x 8x2.5" AnyBay G5 (BLL2)
75B	16 (16)	0	16	0	0	0	0	0	0	0	0	2x 8x2.5" AnyBay G5 (BLL2)
82A	8 (8)	0	8	0	0	0	0	0	0	0	0	1x 8x2.5" AnyBay G5 (BLL2)
82B	8 (8)	0	8	0	0	0	0	0	0	0	0	1x 8x2.5" AnyBay G5 (BLL2)
83A	8 (8)	0	0	8	0	0	0	0	0	0	0	1x 8x2.5" NVMe G5 (BS7Y)
83B	8 (8)	0	0	8	0	0	0	0	0	0	0	1x 8x2.5" NVMe G5 (BS7Y)
84A	16 (8)	8	8	0	0	0	0	0	0	0	0	1x 8x2.5" SAS/SATA (B8LU) + 1x 8x2.5" AnyBay G5 (BLL2)

Config	Total drives (NVMe)	Front			Mid			Rear				Backplanes
		SAS/SATA	Any Bay	NVMe	3.5" SAS	2.5" SAS	2.5" NVMe	3.5" SAS	2.5" SAS	2.5" NVMe	2.5" Any	
84B	16 (8)	8	8	0	0	0	0	0	0	0	0	1x 8x2.5" SAS/SATA (B8LU) + 1x 8x2.5" AnyBay G5 (BLL2)
85A	16 (8)	8	0	8	0	0	0	0	0	0	0	1x 8x2.5" SAS/SATA (B8LU) + 1x 8x2.5" NVMe G5 (BS7Y)
85B	16 (8)	8	0	8	0	0	0	0	0	0	0	1x 8x2.5" SAS/SATA (B8LU) + 1x 8x2.5" NVMe G5 (BS7Y)
86A	24 (8)	16	8	0	0	0	0	0	0	0	0	2x 8x2.5" SAS/SATA (B8LU) + 1x 8x2.5" AnyBay G5 (BLL2)
86B	24 (8)	16	8	0	0	0	0	0	0	0	0	2x 8x2.5" SAS/SATA (B8LU) + 1x 8x2.5" AnyBay G5 (BLL2)
87A	24 (8)	16	0	8	0	0	0	0	0	0	0	2x 8x2.5" SAS/SATA (B8LU) + 1x 8x2.5" NVMe G5 (BS7Y)
87B	24 (8)	16	0	8	0	0	0	0	0	0	0	2x 8x2.5" SAS/SATA (B8LU) + 1x 8x2.5" NVMe G5 (BS7Y)
88	12 (12)	0	0	12	0	0	0	0	0	0	0	2x 8x2.5" NVMe G5 (BS7Y)
89A	16 (16)	0	0	16	0	0	0	0	0	0	0	2x 8x2.5" NVMe G5 (BS7Y)
89B	16 (16)	0	0	16	0	0	0	0	0	0	0	2x 8x2.5" NVMe G5 (BS7Y)
89C	16 (16)	0	0	16	0	0	0	0	0	0	0	2x 8x2.5" NVMe G5 (BS7Y)
90A	16 (16)	0	8	8	0	0	0	0	0	0	0	1x 8x2.5" AnyBay G5 (BLL2) + 1x 8x2.5" NVMe G5 (BS7Y)
90B	16 (16)	0	8	8	0	0	0	0	0	0	0	1x 8x2.5" AnyBay G5 (BLL2) + 1x 8x2.5" NVMe G5 (BS7Y)
90C	16 (16)	0	8	8	0	0	0	0	0	0	0	1x 8x2.5" AnyBay G5 (BLL2) + 1x 8x2.5" NVMe G5 (BS7Y)
91A	24 (16)	8	0	16	0	0	0	0	0	0	0	1x 8x2.5" SAS/SATA (B8LU) + 2x 8x2.5" NVMe G5 (BS7Y)
91B	24 (16)	8	0	16	0	0	0	0	0	0	0	1x 8x2.5" SAS/SATA (B8LU) + 2x 8x2.5" NVMe G5 (BS7Y)
92	16 (12)	4	12	0	0	0	0	0	0	0	0	2x 8x2.5" AnyBay G5 (BLL2)
93A	16 (16)	0	16	0	0	0	0	0	0	0	0	2x 8x2.5" AnyBay G5 (BLL2)
93B	16 (16)	0	16	0	0	0	0	0	0	0	0	2x 8x2.5" AnyBay G5 (BLL2)
93C	16 (16)	0	16	0	0	0	0	0	0	0	0	2x 8x2.5" AnyBay G5 (BLL2)
93D	16 (16)	0	16	0	0	0	0	0	0	0	0	2x 8x2.5" AnyBay G5 (BLL2)
94A	24 (24)	0	0	24	0	0	0	0	0	0	0	3x 8x2.5" NVMe G5 (BS7Y)
94B	24 (24)	0	0	24	0	0	0	0	0	0	0	3x 8x2.5" NVMe G5 (BS7Y)
95A	24 (24)	0	8	16	0	0	0	0	0	0	0	1x 8x2.5" AnyBay G5 (BLL2) + 2x 8x2.5" NVMe G5 (BS7Y)
95B	24 (24)	0	8	16	0	0	0	0	0	0	0	1x 8x2.5" AnyBay G5 (BLL2) + 2x 8x2.5" NVMe G5 (BS7Y)
96	28 (8)	16	8	0	0	0	0	0	4	0	0	Front: 2x 8x2.5" SAS/SATA (B8LU) + 1x 8x2.5" AnyBay G5 (BLL2); Rear: 4x2.5" SAS/SATA (B8LV)
98	28 (28)	0	0	24	0	0	0	0	0	4	0	Front: 3x 8x2.5" NVMe G5 (BS7Y); Rear: 1x 4x2.5" NVMe G5 (BQZM)
103	32 (32)	0	0	24	0	0	8	0	0	0	0	Front: 3x 8x2.5" NVMe G5 (BS7Y); Mid: 2x 4x2.5" NVMe G5 (BS81)
104	36 (36)	0	0	24	0	0	8	0	0	4	0	Front: 3x 8x2.5" NVMe G5 (BS7Y); Mid: 2x 4x2.5" NVMe G5 (BS81); Rear: 1x 4x2.5" NVMe G5 (BQZM)
105	8 (8)	0	8	0	0	0	0	0	0	0	0	1x 8x2.5" AnyBay G5 (BLL2)
106	16 (16)	0	16	0	0	0	0	0	0	0	0	2x 8x2.5" AnyBay G5 (BLL2)

Config	Total drives (NVMe)	Front			Mid			Rear				Backplanes
		SAS/SATA	Any Bay	NVMe	3.5" SAS	2.5" SAS	2.5" NVMe	3.5" SAS	2.5" SAS	2.5" NVMe	2.5" Any	
107	24 (16)	8	16	0	0	0	0	0	0	0	0	1x 8x2.5" SAS/SATA (B8LU) + 2x 8x2.5" AnyBay G5 (BLL2)
108	24 (24)	0	24	0	0	0	0	0	0	0	0	3x 8x2.5" AnyBay G5 (BLL2)

Overview - 2.5-inch front drives supporting 12 PCIe slots (front & rear)

The following table summarizes the configurations that use 2.5-inch front drives supporting 12 PCIe slots (front & rear). Such a configuration supports up to 16x 2.5-inch drive bays + PCIe slots at the front of the server.

Click to jump down to the [details of the 2.5-inch front drive configurations](#).

Return to [Storage configurations](#).

Field upgrades: For part number upgrades, see the [Drive bay field upgrades - 2.5-inch chassis with front slots](#) section.

Table 32. Overview - 2.5-inch front drives supporting 12 PCIe slots (front & rear)

Config	Total drives (NVMe)	Front			Mid			Rear				Backplanes
		SAS/SATA	Any Bay	NVMe	3.5" SAS	2.5" SAS	2.5" NVMe	3.5" SAS	2.5" SAS	2.5" NVMe	2.5" Any	
31	8 (0)	8	0	0	0	0	0	0	0	0	0	1x 8x2.5" SAS/SATA (B8LU)
32	8 (8)	0	8	0	0	0	0	0	0	0	0	1x 8x2.5" AnyBay G4 (BH8B)
33	8 (8)	0	8	0	0	0	0	0	0	0	0	1x 8x2.5" AnyBay G4 (BH8B)
34	8 (8)	0	0	8	0	0	0	0	0	0	0	1x 8x2.5" NVMe G4 (BH8D)
35	16 (0)	16	0	0	0	0	0	0	0	0	0	2x 8x2.5" SAS/SATA (B8LU)
36	16 (8)	8	8	0	0	0	0	0	0	0	0	1x 8x2.5" SAS/SATA (B8LU) + 1x 8x2.5" AnyBay G4 (BH8B)
37	16 (8)	8	0	8	0	0	0	0	0	0	0	1x 8x2.5" SAS/SATA (B8LU) + 1x 8x2.5" NVMe G4 (BH8D)
38	16 (16)	0	0	16	0	0	0	0	0	0	0	2x 8xNVMe G4 (BH8D)
39	16 (16)	0	16	0	0	0	0	0	0	0	0	2x 8x2.5" AnyBay G4 (BH8B)
40	14 (0)	14	0	0	0	0	0	0	0	0	0	2x 8x2.5" SAS/SATA (B8LU) (14 bays max)
100	8 (8)	0	8	0	0	0	0	0	0	0	0	1x 8x2.5" AnyBay G5 (BLL2)
101	8 (8)	0	0	8	0	0	0	0	0	0	0	1x 8x2.5" NVMe G5 (BS7Y)
102	16 (16)	0	0	16	0	0	0	0	0	0	0	2x 8x2.5" NVMe G5 (BS7Y)
109	8 (8)	0	8	0	0	0	0	0	0	0	0	1x 8x2.5" AnyBay G5 (BLL2)
110	16 (16)	0	16	0	0	0	0	0	0	0	0	2x 8x2.5" AnyBay G5 (BLL2)

Details - 3.5-inch front bays

The following table details the configurations that use 3.5-inch front drive bays.

Click to go to the [overview of the 3.5-inch front drive configurations](#).

Return to [Storage configurations](#).

In the table:

- **M.2 + VROC (SATA)** means the M.2 SATA/x4 NVMe adapter (4Y37A79663) with SATA drives. RAID is optional, provided using VROC.
- **M.2 + VROC (NVMe)** means the M.2 SATA/x4 NVMe adapter (4Y37A79663) with NVMe drives. RAID is optional, provided using VROC.

- **M.2 + RAID adapter** means the M.2 SATA/x4 NVMe adapter (4Y37A79663) with either a RAID 5350-8i adapter (supporting SATA drives) or a RAID 540-8i (supporting NVMe drives). Adapter installs in a rear PCIe slot.
- **M.2 RAID (NVMe)** means the M.2 RAID NVMe adapter (B8P9) with NVMe drives. SATA drives not supported. RAID-0 and RAID-1 are supported with the integrated Marvell RAID controller.
- **7mm + VROC (SATA)** means the 7mm SATA/NVMe kit (BU0N) with SATA drives. RAID is optional, provided using VROC.
- **7mm + VROC (NVMe)** means the 7mm SATA/NVMe kit (BU0N) with NVMe drives. RAID is optional, provided using VROC.
- **7mm + RAID adapter** means the 7mm SATA/NVMe kit (BU0N) with either a RAID 5350-8i adapter (supporting SATA drives) or a RAID 540-8i (supporting NVMe drives). Adapter installs in a rear PCIe slot.
- **7mm RAID (NVMe)** means the 7mm NVMe RAID kit (B8P3) with NVMe drives. SATA drives not supported. RAID-0 and RAID-1 are supported with the integrated Marvell RAID controller.

Tip: M.2 and 7mm are mutually exclusive: they are not supported together in the same configuration

Table 33. Details - 3.5-inch front bays

Config	CPUs	Front			Mid			Rear			Backplanes	M.2				7mm				Supported controllers												
		SAS/SATA	AnyBay	NVMe	3.5" SAS/SATA	2.5" SAS/SATA	2.5" NVMe	3.5" SAS/SATA	2.5" SAS/SATA	2.5" NVMe		2.5" AnyBay	M.2 + VROC (SATA)	M.2 + VROC (NVMe)	M.2 + RAID adapter	M.2 RAID (NVMe)	7mm + VROC (SATA)	7mm + VROC (NVMe)	7mm + RAID adapter		7mm RAID (NVMe)											
1-1	1 or 2	8	0	0	0	0	0	0	0	0	0	0	0	0	0	0	0	0	0	0	8x3.5" SAS/SATA (B8LP)	Y	Y	Y	Y	Y	Y	Y	Y	Y	OB SATA	
1-2	1 or 2																						Y	Y	Y	Y	Y	Y	Y	(5350-8i or 9350-8i or 4350-8i)		
1-3	1 or 2																						Y	Y	Y	Y	Y	Y	Y	(940-8i or 540-8i or 440-8i)		
2-1	1 or 2	12	0	0	0	0	0	0	0	0	0	0	0	0	0	0	0	0	0	0	0	12x3.5" SAS/SATA (B8LT)	Y	Y	Y	Y	Y	Y	Y	Y	Y	OB SATA
2-2	1 or 2																						Y	Y	Y	Y	Y	Y	Y	(9350-16i or 4350-16i)		
2-3	1 or 2																						Y	Y	Y	Y	Y	Y	Y	(940-16i or 540-16i or 440-16i)		
3-1	1 or 2	12	0	0	0	0	0	2	0	0	0	0	0	0	0	0	0	0	0	0	0	Front: 12x3.5" SAS/SATA (B8LT); Rear: 2x3.5" SAS/SATA (BAG7)	N	Y	Y	N	N	Y	Y	N	N	OB SATA
3-2	1 or 2																						Y	Y	Y	Y	Y	Y	Y	(9350-16i or 4350-16i)		
3-3	1 or 2																						Y	Y	Y	Y	Y	Y	Y	(940-16i or 540-16i or 440-16i)		
4-1	1 or 2	12	0	0	0	0	0	4	0	0	0	0	0	0	0	0	0	0	0	0	0	Front: 12x3.5" SAS/SATA (B8LT); Rear: 4x3.5" SAS/SATA (B8L3)	N	Y	N	N	N	N	N	N	N	(9350-16i or 4350-16i)
4-2	1 or 2																						N	Y	N	N	N	N	N	(940-16i or 540-16i or 440-16i)		
5-1	1 or 2	12	0	0	0	0	0	0	4	0	0	0	0	0	0	0	0	0	0	0	0	Front: 12x3.5" SAS/SATA (B8LT); Rear: 4x2.5" SAS/SATA (B8LV)	Y	Y	Y	Y	N	N	N	N	N	(9350-16i or 4350-16i)
5-2	1 or 2																						Y	Y	Y	Y	N	N	N	(940-16i or 540-16i or 440-16i)		

Config	CPUs	Front		Mid			Rear		Backplanes				M.2				7mm				Supported controllers	
		SAS/SATA	AnyBay	NVMe	3.5" SAS/SATA	2.5" SAS/SATA	2.5" NVMe	3.5" SAS/SATA	2.5" SAS/SATA	2.5" NVMe	2.5" AnyBay	M.2 + VROC (SATA)	M.2 + VROC (NVMe)	M.2 + RAID adapter	M.2 RAID (NVMe)	7mm + VROC (SATA)	7mm + VROC (NVMe)	7mm + RAID adapter	7mm RAID (NVMe)			
43-1	1 or 2	12	0	0	0	0	0	4	0	0	0	Front: 12x3.5" SAS/SATA with Expander (BQ2S); Rear: 4x3.5" SAS/SATA (B8L3)	Y	Y	Y	Y	N	N	N	N	(5350-8i or 9350-8i or 4350-8i)	
43-2	1 or 2												Y	Y	Y	Y	N	N	N	N		(940-8i or 540-8i or 440-8i)
44-1	2 only	12	0	0	0	0	0	0	0	0	4	Front: 12x3.5" SAS/SATA with Expander (BQ2S); Rear: 4x 2.5" AnyBay G5 (BSE3)	Y	Y	Y	Y	N	N	N	N	Front: (5350-8i or 9350-8i or 4350-8i); Rear: OB NVMe	
44-2	2 only												Y	Y	Y	Y	N	N	N	N		Front: (940-8i or 540-8i or 440-8i); Rear: OB NVMe
45-1	1 or 2	12	0	0	0	0	0	2	0	0	0	Front: 12x3.5" SAS/SATA with Expander (BQ2S); Rear: 2x3.5" SAS/SATA (BAG7)	Y	Y	Y	Y	Y	Y	Y	Y	(5350-8i or 9350-8i or 4350-8i)	
45-2	1 or 2												Y	Y	Y	Y	Y	Y	Y	Y		(940-8i or 540-8i or 440-8i)
46-1	1 or 2	12	0	0	4	0	0	4	0	0	0	Front: 12x3.5" SAS/SATA with Expander (BQ2S); Mid: 4x3.5" SAS/SATA (BCQK); Rear: 4x3.5" SAS/SATA (B8L3)	N	N	N	Y	N	N	N	N	(9350-16i or 4350-16i)	
46-2	1 or 2												N	N	N	Y	N	N	N	N		(940-16i or 540-16i or 440-16i)
54-1	2 only	12	0	0	0	0	0	0	0	0	4	Front: 12x3.5" SAS/SATA (B8LT); Rear: 4x 2.5" AnyBay G5 (BSE3)	Y	Y	Y	Y	N	N	N	N	(9350-16i or 4350-16i) + OB NVMe	
54-2	2 only												Y	Y	Y	Y	N	N	N	N		(940-16i or 540-16i or 440-16i) + OB NVMe
99-1	2 only	12	0	0	0	0	8	0	0	0	0	Front: 12x3.5" SAS/SATA (B8LT); Mid: 2x 4x2.5" NVMe G5 (BS81)	Y	Y	Y	Y	Y	Y	Y	Y	Y	Front: OB SATA; Mid: OB NVMe
99-2	2 only												Y	Y	Y	Y	Y	Y	Y	Y	Front: (9350-16i or 4350-16i); Mid: OB NVMe	
99-3	2 only												Y	Y	Y	Y	Y	Y	Y	Y	Front: (940-16i or 540-16i or 440-16i); Mid: OB NVMe	

* For M.2 or 7mm: Requires 2 processors; 1P not supported

Details - 2.5-inch front bays supporting rear slots (no front PCIe slots)

The following table details the configurations that use 2.5-inch front bays supporting rear slots (no front PCIe slots).

Click to go to the [overview of the 2.5-inch front drive configurations](#).

Return to [Storage configurations](#).

In the table:

- **M.2 + VROC (SATA)** means the M.2 SATA/x4 NVMe adapter (4Y37A79663) with SATA drives. RAID is optional, provided using VROC.

- **M.2 + VROC (NVMe)** means the M.2 SATA/x4 NVMe adapter (4Y37A79663) with NVMe drives. RAID is optional, provided using VROC.
- **M.2 + RAID adapter** means the M.2 SATA/x4 NVMe adapter (4Y37A79663) with either a RAID 5350-8i adapter (supporting SATA drives) or a RAID 540-8i (supporting NVMe drives)
- **M.2 RAID (NVMe)** means the M.2 RAID NVMe adapter (B8P9) with NVMe drives. SATA drives not supported. RAID-0 and RAID-1 are supported with the integrated Marvell RAID controller.
- **7mm + VROC (SATA)** means the 7mm SATA/NVMe kit (BU0N) with SATA drives. RAID is optional, provided using VROC.
- **7mm + VROC (NVMe)** means the 7mm SATA/NVMe kit (BU0N) with NVMe drives. RAID is optional, provided using VROC.
- **7mm + RAID adapter** means the 7mm SATA/NVMe kit (BU0N) with either a RAID 5350-8i adapter (supporting SATA drives) or a RAID 540-8i (supporting NVMe drives)
- **7mm RAID (NVMe)** means the 7mm NVMe RAID kit (B8P3) with NVMe drives. SATA drives not supported. RAID-0 and RAID-1 are supported with the integrated Marvell RAID controller.

Tip: M.2 and 7mm are mutually exclusive: they are not supported together in the same configuration

Table 34. Details - 2.5-inch front bays supporting rear slots (no front PCIe slots)

Config	CPUs	Front		Mid			Rear				Backplanes	M.2				7mm				Supported controllers																						
		SAS/SATA	AnyBay	NVMe	3.5" SAS/SATA	2.5" SAS/SATA	2.5" NVMe	3.5" SAS/SATA	2.5" SAS/SATA	2.5" NVMe		2.5" AnyBay	M.2 + VROC (SATA)	M.2 + VROC (NVMe)	M.2 + RAID adapter	M.2 RAID (NVMe)	7mm + VROC (SATA)	7mm + VROC (NVMe)	7mm + RAID adapter		7mm RAID (NVMe)																					
9-1	1 or 2	8	0	0	0	0	0	0	0	0	0	0	0	0	0	0	0	0	0	0	0	1x 8x2.5" SAS/SATA (B8LU)	Y	Y	Y	Y	Y	Y	Y	Y	OB SATA											
9-2	1 or 2																														(5350-8i or 9350-8i or 4350-8i)											
9-3	1 or 2																														(940-8i or 540-8i or 440-8i)											
9-4	1 or 2																														(9350-16i or 4350-16i)											
9-5	1 or 2																														(940-16i or 540-16i or 440-16i)											
9-6	2 only																														(5350-8i CFF or 9350-8i CFF or 940-16i CFF or 440-16i CFF)											
9-6-1	1 only																														(5350-8i CFF or 9350-8i CFF or 940-16i CFF or 440-16i CFF)											
10-1	2 only	0	8	0	0	0	0	0	0	0	0	0	0	0	0	0	0	0	0	0	0	0	0	0	0	0	0	0	0	0	1x 8x2.5" AnyBay G4 (BH8B)	Y	Y	Y	Y	Y	Y	Y	Y	Y	Y	(5350-8i or 9350-8i or 4350-8i) + OB NVMe
10-2	2 only																															(940-8i or 540-8i or 440-8i) + OB NVMe										
10-3	2 only																															(9350-16i or 4350-16i) + OB NVMe										
10-4	2 only																															(940-16i or 540-16i or 440-16i) + OB NVMe										
10-5	2 only																															(5350-8i CFF or 9350-8i CFF or 940-16i CFF or 440-16i CFF) + OB NVMe										

Config	CPUs	Front		Mid			Rear			Backplanes	M.2				7mm				Supported controllers	
		SAS/SATA	AnyBay	NVMe	3.5" SAS/SATA	2.5" SAS/SATA	2.5" NVMe	3.5" SAS/SATA	2.5" SAS/SATA		2.5" NVMe	2.5" AnyBay	M.2 + VROC (SATA)	M.2 + VROC (NVMe)	M.2 + RAID adapter	M.2 RAID (NVMe)	7mm + VROC (SATA)	7mm + VROC (NVMe)		7mm + RAID adapter
10-6	1 only										Y	N*	Y	Y	Y	N*	Y	Y	(5350-8i or 9350-8i or 4350-8i) + OB NVMe	
10-7	1 only										Y	N*	Y	Y	Y	N*	Y	Y	(940-8i or 540-8i or 440-8i) + OB NVMe	
10-8	1 only										Y	N*	Y	Y	Y	N*	Y	Y	(9350-16i or 4350-16i) + OB NVMe	
10-9	1 only										Y	N*	Y	Y	Y	N*	Y	Y	(940-16i or 540-16i or 440-16i) + OB NVMe	
11-1	2 only	0	0	8	0	0	0	0	0	0	1x 8x2.5" NVMe G4 (BH8D)	Y	N	Y	Y	Y	N	Y	Y	OB NVMe
11-2	1 only											Y	N	Y	Y	Y	N	Y	Y	OB NVMe
12-1	2 only	16	0	0	0	0	0	0	0	0	2x 8x2.5" SAS/SATA (B8LU)	Y	Y	Y	Y	Y	Y	Y	Y	(9350-16i or 4350-16i)
12-2	2 only											Y	Y	Y	Y	Y	Y	Y	Y	(940-16i or 540-16i or 440-16i)
12-3	2 only											Y	Y	Y	Y	Y	Y	Y	Y	(2x 5350-8i or 2x 9350-8i or 2x 4350-8i)
12-4	2 only											Y	Y	Y	Y	Y	Y	Y	Y	2x (940-8i or 540-8i or 440-8i)
12-5	2 only											Y	Y	Y	Y	Y	Y	Y	Y	(9350-16i CFF or 940-16i CFF or 440-16i CFF)
12-5-1	2 only											Y	Y	Y	Y	Y	Y	Y	Y	(9350-16i CFF or 940-16i CFF or 440-16i CFF)
12-6	2 only											Y	Y	Y	Y	Y	Y	Y	Y	(5350-8i or 9350-8i or 4350-8i) + OB SATA
12-7	2 only											Y	Y	Y	Y	Y	Y	Y	Y	(940-8i or 540-8i or 440-8i) + OB SATA
13-1	2 only	0	8	8	0	0	0	0	0	0	8x2.5" NVMe G4 (BH8D) + 8x2.5" AnyBay G4 (BH8B)	Y	Y	Y	Y	Y	Y	Y	Y	(5350-8i or 9350-8i or 4350-8i) + OB NVMe
13-2	2 only											Y	Y	Y	Y	Y	Y	Y	Y	(940-8i or 540-8i or 440-8i) + OB NVMe
13-3	2 only											Y	Y	Y	Y	Y	Y	Y	Y	(5350-8i CFF or 9350-8i CFF or 940-16i CFF or 440-16i CFF) + OB NVMe
14A-1	2 only	0	0	16	0	0	0	0	0	0	2x 8xNVMe G4 (BH8D)	Y	Y	Y	Y	Y	Y	Y	Y	OB NVMe
14B-1	1 or 2	0	16	0	0	0	0	0	0	0	2x 8x2.5" AnyBay G4 (BH8B)	Y	Y*	Y	Y	Y	Y*	Y	Y	940-16i Tri-mode
14B-2	1 or 2											Y	Y*	Y	Y	Y	Y*	Y	Y	2x 940-8i Tri-mode
15-1	2 only	8	8	0	0	0	0	0	0	0	1x 8x2.5" SAS/SATA (B8LU) + 1x 8x2.5" AnyBay G4 (BH8B)	Y	Y	Y	Y	Y	Y	Y	Y	(9350-16i or 4350-16i) + OB NVMe
15-2	2 only											Y	Y	Y	Y	Y	Y	Y	Y	(940-16i or 540-16i or 440-16i) + OB NVMe
15-3	2 only											Y	Y	Y	Y	Y	N	Y	Y	(2x 5350-8i or 2x 9350-8i or 2x 4350-8i) + OB NVMe
15-4	2 only											Y	Y	Y	Y	Y	N	Y	Y	2x (940-8i or 540-8i or 440-8i) + OB NVMe

Config	CPUs	Front		Mid			Rear			Backplanes	M.2				7mm				Supported controllers			
		SAS/SATA	AnyBay	NVMe	3.5" SAS/SATA	2.5" SAS/SATA	2.5" NVMe	3.5" SAS/SATA	2.5" SAS/SATA		2.5" NVMe	2.5" AnyBay	M.2 + VROC (SATA)	M.2 + VROC (NVMe)	M.2 + RAID adapter	M.2 RAID (NVMe)	7mm + VROC (SATA)	7mm + VROC (NVMe)		7mm + RAID adapter	7mm RAID (NVMe)	
15-5	2 only																			(9350-16i CFF or 940-16i CFF or 440-16i CFF) + OB NVMe		
15-6	1 only																			(9350-16i or 4350-16i) + OB NVMe		
15-7	1 only																			(940-16i or 540-16i or 440-16i) + OB NVMe		
15-8	1 only																			(2x 5350-8i or 2x 9350-8i or 2x 4350-8i) + OB NVMe		
15-9	1 only																			2x (940-8i or 540-8i or 440-8i) + OB NVMe		
16-1	2 only	8	0	8	0	0	0	0	0	0	0	0	0	0	0	0	0	0	0	1x 8x2.5" SAS/SATA (B8LU) + 1x 8x2.5" NVMe G4 (BH8D)	Y Y Y Y Y Y Y Y	OB SATA + OB NVMe
16-2	2 only																			(5350-8i or 9350-8i or 4350-8i) + OB NVMe		
16-3	2 only																			(940-8i or 540-8i or 440-8i) + OB NVMe		
16-3-1	2 only																			(5350-8i CFF or 9350-8i CFF or 940-16i CFF or 440-16i CFF) + OB NVMe		
16-4	1 only																			OB SATA + OB NVMe		
16-5	1 only																			(5350-8i or 9350-8i or 4350-8i) + OB NVMe		
16-6	1 only																			(940-8i or 540-8i or 440-8i) + OB NVMe		
17-1	2 only	16	8	0	0	0	0	0	0	0	0	0	0	0	0	0	0	0	0	2x 8x2.5" SAS/SATA (B8LU) + 1x 8x2.5" AnyBay G4 (BH8B)	Y N Y Y Y N Y Y	940-32i + OB NVMe
17-2	2 only																			(5350-8i or 9350-8i or 4350-8i) + OB NVMe + Exp-44i		
17-3	2 only																			(940-8i or 540-8i or 440-8i) + OB NVMe + Exp-44i		
17-5	2 only																			3x (940-8i or 540-8i or 440-8i) + OB NVMe		
17-6	1 only																			940-32i + OB NVMe		
17-7	1 only																			(5350-8i or 9350-8i or 4350-8i) + OB NVMe + Exp-44i		
17-8	1 only																			(940-8i or 540-8i or 440-8i) + OB NVMe + Exp-44i		
18-1-1	2 only	16	0	8	0	0	0	0	0	0	0	0	0	0	0	0	0	0	0	2x 8x2.5" SAS/SATA (B8LU) + 1x 8x2.5" NVMe G4 (BH8D)	Y N Y Y Y N Y Y	(9350-16i or 4350-16i) + OB NVMe
18-1	2 only																			(940-16i or 540-16i or 440-16i) + OB NVMe		

Config	CPUs	Front		Mid			Rear				Backplanes	M.2				7mm				Supported controllers	
		SAS/SATA	AnyBay	NVMe	3.5" SAS/SATA	2.5" SAS/SATA	2.5" NVMe	3.5" SAS/SATA	2.5" SAS/SATA	2.5" NVMe		2.5" AnyBay	M.2 + VROC (SATA)	M.2 + VROC (NVMe)	M.2 + RAID adapter	M.2 RAID (NVMe)	7mm + VROC (SATA)	7mm + VROC (NVMe)	7mm + RAID adapter		7mm RAID (NVMe)
18-2	2 only											Y	N	Y	Y	Y	N	Y	Y	(5350-8i or 9350-8i or 4350-8i) + OB NVMe + Exp-44i	
18-3	2 only											Y	N	Y	Y	Y	N	Y	Y	(940-8i or 540-8i or 440-8i) + OB NVMe + Exp-44i	
18-4	1 only											Y	N	Y	Y	Y	N	Y	Y	(5350-8i or 9350-8i or 4350-8i) + OB NVMe + Exp-44i	
18-5	1 only											Y	N	Y	Y	Y	N	Y	Y	(940-8i or 540-8i or 440-8i) + OB NVMe + Exp-44i	
19A-1	2 only	8	0	16	0	0	0	0	0	0	0	Y	Y	Y	Y	Y	Y	Y	Y	(5350-8i or 9350-8i or 4350-8i) + OB NVMe	
19A-2	2 only											Y	Y	Y	Y	Y	Y	Y	Y	(940-8i or 540-8i or 440-8i) + OB NVMe	
19B-1	1 or 2	8	16	0	0	0	0	0	0	0	0	Y	Y	Y	Y	Y	Y	Y	Y	(940-8i or 540-8i or 440-8i) + 940-16i Tri-mode	
20-1	1 or 2	24	0	0	0	0	0	0	0	0	0	Y	Y	Y	Y	Y	Y	Y	Y	940-32i	
20-2	2 only																				(9350-16i CFF or 940-16i CFF or 440-16i CFF) + Exp-44i
20-2-1	1 only																				(9350-16i CFF or 940-16i CFF or 440-16i CFF) + Exp-44i
20-3	1 or 2																				(5350-8i or 9350-8i or 4350-8i) + Exp-44i
20-4	1 or 2																				(940-8i or 540-8i or 440-8i) + Exp-44i
20-5	1 or 2																				3x (5350-8i or 9350-8i or 4350-8i)
20-6	1 or 2																				3x (940-8i or 540-8i or 440-8i)
20-7	1 or 2																				(9350-16i or 4350-16i) + (5350-8i or 9350-8i or 4350-8i)
20-8	1 or 2																				(940-16i or 540-16i or 440-16i) + (940-8i or 540-8i or 440-8i)
21A-1	2 only	0	0	24	0	0	0	0	0	0	0	Y	N	Y	Y	Y	N	Y	Y	OB NVMe + Retimer	
21B-1	1 or 2	0	24	0	0	0	0	0	0	0	0	Y	Y	Y	Y	Y	Y	Y	Y	940-16i Tri-mode + 940-8i Tri-mode	
21B-2	1 or 2																				3x 940-8i Tri-mode

Config	CPUs	Front		Mid			Rear			Backplanes	M.2				7mm				Supported controllers										
		SAS/SATA	AnyBay	NVMe	3.5" SAS/SATA	2.5" SAS/SATA	2.5" NVMe	3.5" SAS/SATA	2.5" SAS/SATA		2.5" NVMe	2.5" AnyBay	M.2 + VROC (SATA)	M.2 + VROC (NVMe)	M.2 + RAID adapter	M.2 RAID (NVMe)	7mm + VROC (SATA)	7mm + VROC (NVMe)		7mm + RAID adapter	7mm RAID (NVMe)								
21C-1	2 only	0	8	16	0	0	0	0	0	0	0	0	0	0	0	0	0	0	0	1x 8x2.5" AnyBay G4 (BH8B) + 2x 8x2.5" NVMe G4 (BH8D)	Y	N	Y	Y	Y	N	Y	Y	(5350-8i or 9350-8i or 4350-8i) + OB NVMe + 1x Retimer
21C-2	2 only																				Y	N	Y	Y	Y	N	Y	Y	(940-8i or 540-8i or 440-8i) + OB NVMe + 1x Retimer
22-1	2 only	16	8	0	0	0	0	0	4	0	0									Front: 2x 8x2.5" SAS/SATA (B8LU) + 1x 8x2.5" AnyBay G4 (BH8B); Rear: 4x2.5" SAS/SATA (B8LV)	Y	Y	Y	Y	N	N	N	N	940-32i + OB NVMe
22-2	2 only																				Y	Y	Y	Y	N	N	N	N	(5350-8i or 9350-8i or 4350-8i) + OB NVMe + Exp-44i
22-3	2 only																				Y	Y	Y	Y	N	N	N	N	(940-8i or 540-8i or 440-8i) + OB NVMe + Exp-44i
22-4	2 only																				Y	Y	Y	Y	N	N	N	N	(9350-16i CFF or 940-16i CFF or 440-16i CFF) + OB NVMe + Exp-44i
22-5	2 only																				Y	Y	N	Y	N	N	N	N	4x (5350-8i or 9350-8i or 4350-8i) + OB NVMe
22-6	2 only																				Y	Y	N	Y	N	N	N	N	4x (940-8i or 540-8i or 440-8i) + OB NVMe
22-7	1 only																				Y	N*	Y	Y	N	N	N	N	940-32i + OB NVMe
22-8	1 only																				Y	N*	Y	Y	N	N	N	N	(5350-8i or 9350-8i or 4350-8i) + OB NVMe + Exp-44i
22-9	1 only																				Y	N*	Y	Y	N	N	N	N	(940-8i or 540-8i or 440-8i) + OB NVMe + Exp-44i
23-1	1 or 2	24	0	0	0	0	0	0	4	0	0									Front: 3x 8x2.5" SAS/SATA (B8LU); Rear: 4x2.5" SAS/SATA (B8LV)	Y	Y	Y	Y	N	N	N	N	940-32i
23-2	1 or 2																				Y	Y	Y	Y	N	N	N	N	(5350-8i or 9350-8i or 4350-8i) + Exp-44i
23-3	1 or 2																				Y	Y	Y	Y	N	N	N	N	(940-8i or 540-8i or 440-8i) + Exp-44i
23-4	1 or 2																				Y	Y	Y	Y	N	N	N	N	(9350-16i or 4350-16i) + Exp-44i
23-5	1 or 2																				Y	Y	Y	Y	N	N	N	N	(940-16i or 540-16i or 440-16i) + Exp-44i
23-6	2 only																				Y	Y	Y	Y	N	N	N	N	(9350-16i CFF or 940-16i CFF or 440-16i CFF) + Exp-44i
23-6-1	1 only																				Y	Y	Y	Y	N	N	N	N	(9350-16i CFF or 940-16i CFF or 440-16i CFF) + Exp-44i
23A-1	1 or 2	24	0	0	0	0	0	0	8	0	0									Front: 3x 8x2.5" SAS/SATA (B8LU); Rear: 8x2.5" SAS/SATA (B97X)	Y	Y	Y	Y	Y	Y	Y	Y	940-32i
23A-2	1 or 2																				Y	Y	Y	Y	Y	Y	N	Y	2x (9350-16i or 4350-16i)
23A-3	1 or 2																				Y	Y	Y	Y	Y	Y	N	Y	2x (940-16i or 540-16i or 440-16i)

Config	CPUs	Front		Mid			Rear			Backplanes	M.2				7mm				Supported controllers	
		SAS/SATA	AnyBay	NVMe	3.5" SAS/SATA	2.5" SAS/SATA	2.5" NVMe	3.5" SAS/SATA	2.5" SAS/SATA		2.5" NVMe	2.5" AnyBay	M.2 + VROC (SATA)	M.2 + VROC (NVMe)	M.2 + RAID adapter	M.2 RAID (NVMe)	7mm + VROC (SATA)	7mm + VROC (NVMe)		7mm + RAID adapter
23A-4	2 only																			9350-16i CFF + (9350-16i or 4350-16i)
23A-4-1	1 only																			9350-16i CFF + (9350-16i or 4350-16i)
23A-5	2 only																			(940-16i CFF or 440-16i CFF) + (940-16i or 540-16i or 440-16i)
23A-5-1	1 only																			(940-16i CFF or 440-16i CFF) + (940-16i or 540-16i or 440-16i)
23A-6	1 or 2																			(5350-8i or 9350-8i or 4350-8i) + Exp-44i
23A-7	1 or 2																			(940-8i or 540-8i or 440-8i) + Exp-44i
23A-8	1 or 2																			(9350-16i or 4350-16i) + Exp-44i
23A-9	1 or 2																			(940-16i or 540-16i or 440-16i) + Exp-44i
23A-10	2 only																			(9350-16i CFF or 940-16i CFF or 440-16i CFF) + Exp-44i
23A-10-1	1 only																			(9350-16i CFF or 940-16i CFF or 440-16i CFF) + Exp-44i
24-1	2 only	0	0	24	0	0	8	0	0	0	0	0	0	0	0	0	0	0	0	Front: 3x 8xNVMe G4 (BH8D); Mid: 2x 4x2.5" NVMe G4 (BDY7)
25-1	1 or 2	24	0	0	0	8	0	0	8	0	0	0	0	0	0	0	0	0	0	Front: 3x 8x2.5" SAS/SATA (B8LU); Mid: 2x 4x2.5" SAS/SATA (BCQL); Rear: 8x2.5" SAS/SATA (B97X)
25-2	1 or 2																			(940-16i or 540-16i or 440-16i) + Exp-44i
25-3	2 only																			(9350-16i CFF or 940-16i CFF or 440-16i CFF) + Exp-44i
25-3-1	1 only																			(9350-16i CFF or 940-16i CFF or 440-16i CFF) + Exp-44i
25A-1	1 or 2	24	0	0	0	4	0	0	0	0	0	0	0	0	0	0	0	0	0	Front: 3x 8x2.5" SAS/SATA (B8LU); Mid: 4x2.5" SAS/SATA (BCQL)
25A-2	1 or 2																			2x (9350-16i or 4350-16i)
25A-3	1 or 2																			2x (940-16i or 540-16i or 440-16i)
25B-1	1 or 2	24	0	0	0	8	0	0	0	0	0	0	0	0	0	0	0	0	0	940-32i
25B-2	1 or 2																			2x (9350-16i or 4350-16i)
25B-3	1 or 2																			2x (940-16i or 540-16i or 440-16i)

Config	CPUs	Front		Mid			Rear			Backplanes	M.2				7mm				Supported controllers			
		SAS/SATA	AnyBay	NVMe	3.5" SAS/SATA	2.5" SAS/SATA	2.5" NVMe	3.5" SAS/SATA	2.5" SAS/SATA		2.5" NVMe	2.5" AnyBay	M.2 + VROC (SATA)	M.2 + VROC (NVMe)	M.2 + RAID adapter	M.2 RAID (NVMe)	7mm + VROC (SATA)	7mm + VROC (NVMe)		7mm + RAID adapter	7mm RAID (NVMe)	
25C-1	1 or 2	24	0	0	0	8	0	0	4	0	0	Front: 3x 8x2.5" SAS/SATA (B8LU); Mid: 2x 4x2.5" SAS/SATA (BCQL); Rear: 4x2.5" SAS/SATA (B8LV)	Y	Y	Y	Y	N	N	N	N	Front: 940-32i; Mid: (940-8i or 540-8i or 440-8i)	
25C-2	1 or 2												Y	Y	Y	Y	N	N	N	N		(5350-8i or 9350-8i or 4350-8i) + Exp-44i
25C-3	1 or 2												Y	Y	Y	Y	N	N	N	N		(940-8i or 540-8i or 440-8i) + Exp-44i
25C-4	1 or 2												Y	Y	Y	Y	N	N	N	N		(9350-16i or 4350-16i) + Exp-44i
25C-5	1 or 2												Y	Y	Y	Y	N	N	N	N		(940-16i or 540-16i or 440-16i) + Exp-44i
25C-6	1 or 2												Y	Y	Y	Y	N	N	N	N		(9350-16i CFF or 940-16i CFF or 440-16i CFF) + Exp-44i
25C-6-1	1 or 2												Y	Y	Y	Y	N	N	N	N		(9350-16i CFF or 940-16i CFF or 440-16i CFF) + Exp-44i
27-1	1 or 2	14	0	0	0	0	0	0	0	0	0	2x 8x2.5" SAS/SATA (B8LU) (14 bays max)	N	Y	Y	N	N	Y	Y	N	OB SATA	
29A-1	2 only	0	16	0	0	0	0	0	0	0	0	2x 8x2.5" AnyBay G4 (BH8B)	Y	Y	Y	Y	Y	Y	Y	Y	(9350-16i or 4350-16i) + OB NVMe	
29A-2	2 only												Y	Y	Y	Y	Y	Y	Y	Y		(940-16i or 540-16i or 440-16i) + OB NVMe
29B-1	2 only	0	16	0	0	0	0	0	0	0	0	2x 8x2.5" AnyBay G4 (BH8B)	Y	N	Y	Y	Y	N	Y	Y	(9350-16i or 4350-16i) + OB NVMe	
29B-2	2 only												Y	N	Y	Y	Y	N	Y	Y		(940-16i or 540-16i or 440-16i) + OB NVMe
41-1	1 or 2	0	8	0	0	0	0	0	0	0	0	1x 8x2.5" AnyBay G4 (BH8B)	Y	Y	Y	Y	Y	Y	Y	Y	940-8i Tri-mode	
47-1	1 or 2	24	0	0	0	0	0	0	0	0	0	24x2.5" SAS/SATA with Expander (BQ2T)	Y	Y	Y	Y	Y	Y	Y	Y	(5350-8i or 9350-8i or 4350-8i)	
47-2	1 or 2												Y	Y	Y	Y	Y	Y	Y	Y		(940-8i or 540-8i or 440-8i)
48-1	1 or 2	24	0	0	0	0	0	0	4	0	0	Front: 24x2.5" SAS/SATA with Expander (BQ2T); Rear: 4x2.5" SAS/SATA (B8LV)	Y	Y	Y	Y	N	N	N	N	(5350-8i or 9350-8i or 4350-8i)	
48-2	1 or 2												Y	Y	Y	Y	N	N	N	N		(940-8i or 540-8i or 440-8i)
49-1	2 only	24	0	0	0	0	0	0	0	0	4	Front: 24x2.5" SAS/SATA with Expander (BQ2T); Rear: 4x 2.5" AnyBay G5 (BSE3)	Y	Y	Y	Y	N	N	N	N	Front: (5350-8i or 9350-8i or 4350-8i) + OB NVMe; Rear: OB NVMe	
49-2	2 only												Y	Y	Y	Y	N	N	N	N		Front: (940-8i or 540-8i or 440-8i) + OB NVMe; Rear: OB NVMe

Config	CPUs	Front		Mid			Rear			Backplanes	M.2				7mm				Supported controllers			
		SAS/SATA	AnyBay	NVMe	3.5" SAS/SATA	2.5" SAS/SATA	2.5" NVMe	3.5" SAS/SATA	2.5" SAS/SATA		2.5" NVMe	2.5" AnyBay	M.2 + VROC (SATA)	M.2 + VROC (NVMe)	M.2 + RAID adapter	M.2 RAID (NVMe)	7mm + VROC (SATA)	7mm + VROC (NVMe)		7mm + RAID adapter	7mm RAID (NVMe)	
50-1	1 or 2	24	0	0	0	0	0	0	8	0	0	Front: 24x2.5" SAS/SATA with Expander (BQ2T); Rear: 8x2.5" SAS/SATA (B97X)	Y	Y	Y	Y	Y	Y	Y	Y	(9350-16i CFF or 940-16i CFF or 440-16i CFF)	
50-2	1 or 2												Y	Y	Y	Y	Y	Y	Y	Y		(9350-16i or 4350-16i)
50-3	1 or 2												Y	Y	Y	Y	Y	Y	Y	Y		(940-16i or 540-16i or 440-16i)
51-1	2 only	0	0	24	0	0	0	0	0	4	0	Front: 3x 8xNVMe G4 (BH8D); Rear: 1x 4x2.5" NVMe G5 (BQZM)	Y	N	Y	Y	N	N	N	N	Front: Retimer + OB NVMe; Rear: Retimer	
52-1	2 only	0	0	24	0	0	8	0	0	4	0	Front: 3x 8xNVMe G4 (BH8D); Mid: 2x 4x2.5" NVMe G4 (BDY7); Rear: 1x 4x2.5" NVMe G5 (BQZM)	Y	N	N	Y	N	N	N	N	Front: Retimer + OB NVMe; Mid: 2x Retimer; Rear: Retimer	
55-1	2 only	24	0	0	0	0	0	0	0	0	4	Front: 3x 8x2.5" SAS/SATA (B8LU); Rear: 4x 2.5" AnyBay G5 (BSE3)	Y	Y	Y	Y	N	N	N	N	940-32i + OB NVMe	
55-2	2 only												Y	Y	Y	Y	N	N	N	N	(5350-8i or 9350-8i or 4350-8i) + OB NVMe + Exp-44i	
55-3	2 only												Y	Y	Y	Y	N	N	N	N	(940-8i or 540-8i or 440-8i) + OB NVMe + Exp-44i	
55-4	2 only												Y	Y	Y	Y	N	N	N	N	(9350-16i or 4350-16i) + OB NVMe + Exp-44i	
55-5	2 only												Y	Y	Y	Y	N	N	N	N	(940-16i or 540-16i or 440-16i) + OB NVMe + Exp-44i	
55-6	2 only												Y	Y	Y	Y	N	N	N	N	(9350-16i CFF or 940-16i CFF or 440-16i CFF) + OB NVMe + Exp-44i	
55-6-1	1 only												Y	Y	Y	Y	N	N	N	N	(9350-16i CFF or 940-16i CFF or 440-16i CFF) + OB NVMe + Exp-44i	
60-1	2 only	0	8	0	0	0	0	0	0	0	0	1x 8x2.5" AnyBay G5 (BLL2)	Y	Y	Y	Y	Y	Y	Y	Y	(5350-8i or 9350-8i or 4350-8i) + OB NVMe	
60-2	2 only												Y	Y	Y	Y	Y	Y	Y	Y	(940-8i or 540-8i or 440-8i) + OB NVMe	
60-3	2 only												Y	Y	Y	Y	Y	Y	Y	Y	(9350-16i or 4350-16i) + OB NVMe	
60-4	2 only												Y	Y	Y	Y	Y	Y	Y	Y	(940-16i or 540-16i or 440-16i) + OB NVMe	
60-5	2 only												Y	Y	Y	Y	Y	Y	Y	Y	(5350-8i CFF or 9350-8i CFF or 940-16i CFF or 440-16i CFF) + OB NVMe	
60-6	1 only												Y	N*	Y	Y	Y	N*	Y	Y	(5350-8i or 9350-8i or 4350-8i) + OB NVMe	

Config	CPUs	Front		Mid			Rear			Backplanes	M.2				7mm				Supported controllers	
		SAS/SATA	AnyBay	NVMe	3.5" SAS/SATA	2.5" SAS/SATA	2.5" NVMe	3.5" SAS/SATA	2.5" SAS/SATA		2.5" NVMe	2.5" AnyBay	M.2 + VROC (SATA)	M.2 + VROC (NVMe)	M.2 + RAID adapter	M.2 RAID (NVMe)	7mm + VROC (SATA)	7mm + VROC (NVMe)		7mm + RAID adapter
60-7	1 only										Y	N*	Y	Y	Y	N*	Y	Y	(940-8i or 540-8i or 440-8i) + OB NVMe	
60-8	1 only										Y	N*	Y	Y	Y	N*	Y	Y	(9350-16i or 4350-16i) + OB NVMe	
60-9	1 only										Y	N*	Y	Y	Y	N*	Y	Y	(940-16i or 540-16i or 440-16i) + OB NVMe	
61-1	2 only	0	0	8	0	0	0	0	0	0	1x 8x2.5" NVMe G5 (BS7Y)	Y	Y	Y	Y	Y	Y	Y	OB NVMe	
61-2	1 only											Y	N*	Y	Y	Y	N*	Y	Y	OB NVMe
62-1	2 only	0	8	8	0	0	0	0	0	0	1x 8x2.5" AnyBay G5 (BLL2) + 1x 8x2.5" NVMe G5 (BS7Y)	Y	Y	Y	Y	Y	Y	Y	Y	(5350-8i or 9350-8i or 4350-8i) + OB NVMe
62-2	2 only											Y	Y	Y	Y	Y	Y	Y	(940-8i or 540-8i or 440-8i) + OB NVMe	
62-3	2 only											Y	Y	Y	Y	Y	Y	Y	(5350-8i CFF or 9350-8i CFF or 940-16i CFF or 440-16i CFF) + OB NVMe	
63-1	2 only	0	0	16	0	0	0	0	0	0	2x 8x2.5" NVMe G5 (BS7Y)	Y	Y	Y	Y	Y	Y	Y	Y	OB NVMe
64-1	2 only	8	8	0	0	0	0	0	0	0	1x 8x2.5" SAS/SATA (B8LU) + 1x 8x2.5" AnyBay G5 (BLL2)	Y	Y	Y	Y	Y	Y	Y	Y	(9350-16i or 4350-16i) + OB NVMe + 1x Retimer
64-2	2 only											Y	Y	Y	Y	Y	Y	Y	(940-16i or 540-16i or 440-16i) + OB NVMe + 1x Retimer	
64-3	2 only											Y	Y	Y	Y	Y	N	Y	(2x 5350-8i or 2x 9350-8i or 2x 4350-8i) + OB NVMe + 1x Retimer	
64-4	2 only											Y	Y	Y	Y	Y	N	Y	2x (940-8i or 540-8i or 440-8i) + OB NVMe + 1x Retimer	
64-5	2 only											Y	Y	Y	Y	Y	Y	Y	(9350-16i CFF or 940-16i CFF or 440-16i CFF) + OB NVMe + 1x Retimer	
64-6	1 only											Y	N*	Y	Y	Y	N*	Y	Y	(9350-16i or 4350-16i) + OB NVMe + 1x Retimer
64-7	1 only											Y	N*	Y	Y	Y	N*	Y	Y	(940-16i or 540-16i or 440-16i) + OB NVMe + 1x Retimer
64-8	1 only											Y	N*	Y	Y	Y	N*	N	Y	(2x 5350-8i or 2x 9350-8i or 2x 4350-8i) + OB NVMe + 1x Retimer
64-9	1 only											Y	N*	Y	Y	Y	N*	N	Y	2x (940-8i or 540-8i or 440-8i) + OB NVMe + 1x Retimer
65-1	1 or 2	8	0	8	0	0	0	0	0	0	1x 8x2.5" SAS/SATA (B8LU) + 1x 8x2.5" NVMe G5 (BS7Y)	Y	Y*	Y	Y	Y	Y*	Y	Y	OB SATA + OB NVMe
65-2	1 or 2											Y	Y*	Y	Y	Y	Y*	Y	Y	(5350-8i or 9350-8i or 4350-8i) + OB NVMe
65-3	1 or 2											Y	Y*	Y	Y	Y	Y*	Y	Y	(940-8i or 540-8i or 440-8i) + OB NVMe

Config	CPUs	Front		Mid			Rear				Backplanes	M.2				7mm				Supported controllers
		SAS/SATA	AnyBay	NVMe	3.5" SAS/SATA	2.5" SAS/SATA	2.5" NVMe	3.5" SAS/SATA	2.5" SAS/SATA	2.5" NVMe		2.5" AnyBay	M.2 + VROC (SATA)	M.2 + VROC (NVMe)	M.2 + RAID adapter	M.2 RAID (NVMe)	7mm + VROC (SATA)	7mm + VROC (NVMe)	7mm + RAID adapter	
65-4	1 or 2											Y	Y*	Y	Y	Y	Y*	Y	Y	(5350-8i CFF or 9350-8i CFF or 940-16i CFF or 440-16i CFF) + OB NVMe
65-5	1 or 2											Y	Y*	Y	Y	Y	Y*	Y	Y	OB SATA + OB NVMe
65-6	1 or 2											Y	Y*	Y	Y	Y	Y*	Y	Y	(5350-8i or 9350-8i or 4350-8i) + OB NVMe
65-7	1 or 2											Y	Y*	Y	Y	Y	Y*	Y	Y	(940-8i or 540-8i or 440-8i) + OB NVMe
67-1	2 only	16	8	0	0	0	0	0	0	0	0	2x 8x2.5" SAS/SATA (B8LU) + 1x 8x2.5" AnyBay G5 (BLL2)	Y	Y	Y	Y	Y	Y	Y	940-32i + OB NVMe
67-2	2 only												Y	Y	Y	Y	Y	Y	Y	(5350-8i or 9350-8i or 4350-8i) + OB NVMe + Exp-44i
67-3	2 only												Y	Y	Y	Y	Y	Y	Y	(940-8i or 540-8i or 440-8i) + OB NVMe + Exp-44i
67-4	2 only												Y	Y	Y	Y	Y	Y	Y	(9350-16i CFF or 940-16i CFF or 440-16i CFF) + OB NVMe + Exp-44i
67-5	2 only												Y	Y	N	Y	Y	N	Y	3x (940-8i or 540-8i or 440-8i) + OB NVMe
67-6	1 only												Y	N*	Y	Y	Y	N*	Y	940-32i + OB NVMe
67-7	1 only												Y	N*	Y	Y	Y	N*	Y	(5350-8i or 9350-8i or 4350-8i) + OB NVMe + Exp-44i
67-8	1 only												Y	N*	Y	Y	Y	N*	Y	(940-8i or 540-8i or 440-8i) + OB NVMe + Exp-44i
68-1	2 only	16	0	8	0	0	0	0	0	0	0	2x 8x2.5" SAS/SATA (B8LU) + 1x 8x2.5" NVMe G5 (BS7Y)	Y	Y	Y	Y	Y	Y	Y	(9350-16i or 4350-16i) + OB NVMe
68-2	2 only												Y	Y	Y	Y	Y	Y	Y	(940-16i or 540-16i or 440-16i) + OB NVMe
68-3	2 only												Y	Y	Y	Y	Y	Y	Y	(5350-8i or 9350-8i or 4350-8i) + OB NVMe + Exp-44i
68-4	2 only												Y	Y	Y	Y	Y	Y	Y	(940-8i or 540-8i or 440-8i) + OB NVMe + Exp-44i
68-5	1 only												Y	N*	Y	Y	Y	N*	Y	(5350-8i or 9350-8i or 4350-8i) + OB NVMe + Exp-44i
68-6	1 only												Y	N*	Y	Y	Y	N*	Y	(940-8i or 540-8i or 440-8i) + OB NVMe + Exp-44i
69-1	2 only	8	0	16	0	0	0	0	0	0	0	1x 8x2.5" SAS/SATA (B8LU) + 2x 8x2.5" NVMe G5 (BS7Y)	Y	Y	Y	Y	Y	Y	Y	(5350-8i or 9350-8i or 4350-8i) + OB NVMe
69-2	2 only												Y	Y	Y	Y	Y	Y	Y	(940-8i or 540-8i or 440-8i) + OB NVMe

Config	CPUs	Front		Mid	Rear	Backplanes	M.2				7mm				Supported controllers																									
		SAS/SATA	AnyBay				NVMe	3.5" SAS/SATA	2.5" SAS/SATA	2.5" NVMe	3.5" SAS/SATA	2.5" SAS/SATA	2.5" NVMe	2.5" AnyBay		M.2 + VROC (SATA)	M.2 + VROC (NVMe)	M.2 + RAID adapter	M.2 RAID (NVMe)	7mm + VROC (SATA)	7mm + VROC (NVMe)	7mm + RAID adapter	7mm RAID (NVMe)																	
70-1	2 only	0	0	24	0	0	0	0	0	0	0	0	0	0	0	0	0	0	0	0	0	0	0	0	3x 8x2.5" NVMe G5 (BS7Y)	Y	N	Y	Y	Y	N	Y	Y	OB NVMe + Retimer						
71-1	2 only	0	8	16	0	0	0	0	0	0	0	0	0	0	0	0	0	0	0	0	0	0	0	0	1x 8x2.5" AnyBay G5 (BLL2) + 2x 8x2.5" NVMe G5 (BS7Y)	Y	N	Y	Y	Y	N	N	Y	(5350-8i or 9350-8i or 4350-8i) + OB NVMe + 1x Retimer						
71-2	2 only																																	(940-8i or 540-8i or 440-8i) + OB NVMe + 1x Retimer						
72-1	1 or 2	16	8	0	0	0	0	0	4	0	0	0	0	0	0	0	0	0	0	0	0	0	0	0	0	Front: 2x 8x2.5" SAS/SATA (B8LU) + 1x 8x2.5" AnyBay G5 (BLL2); Rear: 4x2.5" SAS/SATA (B8LV)	Y	Y*	Y	Y	N	N	N	N	940-32i + OB NVMe					
72-2	1 or 2																																	(5350-8i or 9350-8i or 4350-8i) + OB NVMe + Exp-44i						
72-3	1 or 2																																	(940-8i or 540-8i or 440-8i) + OB NVMe + Exp-44i						
72-4	1 or 2																																	(9350-16i CFF or 940-16i CFF or 440-16i CFF) + OB NVMe + Exp-44i						
72-5	1 or 2																																	4x (5350-8i or 9350-8i or 4350-8i) + OB NVMe						
72-6	1 or 2																																	4x (940-8i or 540-8i or 440-8i) + OB NVMe						
72-7	1 or 2																																	940-32i + OB NVMe						
72-8	1 or 2																																	(5350-8i or 9350-8i or 4350-8i) + OB NVMe + Exp-44i						
72-9	1 or 2																																	(940-8i or 540-8i or 440-8i) + OB NVMe + Exp-44i						
75A-1	2 only	0	16	0	0	0	0	0	0	0	0	0	0	0	0	0	0	0	0	0	0	0	0	0	0	2x 8x2.5" AnyBay G5 (BLL2)	Y	Y	Y	Y	Y	Y	Y	Y	Y	Y	Y	Y	Y	(9350-16i or 4350-16i) + OB NVMe
75A-2	2 only																																		(940-16i or 540-16i or 440-16i) + OB NVMe					
75B-1	2 only	0	16	0	0	0	0	0	0	0	0	0	0	0	0	0	0	0	0	0	0	0	0	0	0	2x 8x2.5" AnyBay G5 (BLL2)	Y	N	Y	Y	Y	N	Y	Y	(9350-16i or 4350-16i) + OB NVMe					
75B-2	2 only																																		(940-16i or 540-16i or 440-16i) + OB NVMe					
82A-1	2 only	0	8	0	0	0	0	0	0	0	0	0	0	0	0	0	0	0	0	0	0	0	0	0	0	1x 8x2.5" AnyBay G5 (BLL2)	Y	Y	Y	Y	Y	Y	Y	Y	Y	Y	Y	Y	Y	(5350-8i or 9350-8i or 4350-8i) + OB NVMe
82A-2	2 only																																		(940-8i or 540-8i or 440-8i) + OB NVMe					
82A-3	2 only																																		(9350-16i or 4350-16i) + OB NVMe					
82A-4	2 only																																		(940-16i or 540-16i or 440-16i) + OB NVMe					
82A-5	2 only																																		(5350-8i CFF or 9350-8i CFF or 940-16i CFF or 440-16i CFF) + OB NVMe					

Config	CPUs	Front		Mid			Rear			Backplanes	M.2				7mm				Supported controllers		
		SAS/SATA	AnyBay	NVMe	3.5" SAS/SATA	2.5" SAS/SATA	2.5" NVMe	3.5" SAS/SATA	2.5" SAS/SATA		2.5" NVMe	2.5" AnyBay	M.2 + VROC (SATA)	M.2 + VROC (NVMe)	M.2 + RAID adapter	M.2 RAID (NVMe)	7mm + VROC (SATA)	7mm + VROC (NVMe)		7mm + RAID adapter	7mm RAID (NVMe)
82A-6	1 only											Y	N*	Y	Y	Y	N*	Y	Y	(5350-8i or 9350-8i or 4350-8i) + OB NVMe	
82A-7	1 only											Y	N*	Y	Y	Y	N*	Y	Y	(940-8i or 540-8i or 440-8i) + OB NVMe	
82A-8	1 only											Y	N*	Y	Y	Y	N*	Y	Y	(9350-16i or 4350-16i) + OB NVMe	
82A-9	1 only											Y	N*	Y	Y	Y	N*	Y	Y	(940-16i or 540-16i or 440-16i) + OB NVMe	
82B-1	2 only	0	8	0	0	0	0	0	0	0	0	1x 8x2.5" AnyBay G5 (BLL2)	Y	Y	Y	Y	Y	Y	Y	(5350-8i or 9350-8i or 4350-8i) + OB NVMe	
82B-2	2 only												Y	Y	Y	Y	Y	Y	Y	(940-8i or 540-8i or 440-8i) + OB NVMe	
82B-3	2 only												Y	Y	Y	Y	Y	Y	Y	(9350-16i or 4350-16i) + OB NVMe	
82B-4	2 only												Y	Y	Y	Y	Y	Y	Y	(940-16i or 540-16i or 440-16i) + OB NVMe	
82B-5	2 only												Y	Y	Y	Y	Y	Y	Y	(5350-8i CFF or 9350-8i CFF or 940-16i CFF or 440-16i CFF) + OB NVMe	
83A-1	2 only	0	0	8	0	0	0	0	0	0	0	1x 8x2.5" NVMe G5 (BS7Y)	Y	Y	Y	Y	Y	Y	Y	OB NVMe	
83A-2	1 only												Y	N*	Y	Y	Y	N*	Y	Y	OB NVMe
83B-1	2 only	0	0	8	0	0	0	0	0	0	0	1x 8x2.5" NVMe G5 (BS7Y)	Y	Y	Y	Y	Y	Y	Y	Y	OB NVMe
84A-1	2 only	8	8	0	0	0	0	0	0	0	0	1x 8x2.5" SAS/SATA (B8LU) + 1x 8x2.5" AnyBay G5 (BLL2)	Y	Y	Y	Y	Y	Y	Y	Y	(9350-16i or 4350-16i) + OB NVMe
84A-2	2 only												Y	Y	Y	Y	Y	Y	Y	(940-16i or 540-16i or 440-16i) + OB NVMe	
84A-3	2 only												Y	Y	Y	Y	Y	N	Y	(2x 5350-8i or 2x 9350-8i or 2x 4350-8i) + OB NVMe	
84A-4	2 only												Y	Y	Y	Y	Y	N	Y	2x (940-8i or 540-8i or 440-8i) + OB NVMe	
84A-5	2 only												Y	Y	Y	Y	Y	Y	Y	(9350-16i CFF or 940-16i CFF or 440-16i CFF) + OB NVMe	
84A-6	1 only												Y	N*	Y	Y	Y	N*	Y	Y	(9350-16i or 4350-16i) + OB NVMe + 1x Retimer
84A-7	1 only												Y	N*	Y	Y	Y	N*	Y	Y	(940-16i or 540-16i or 440-16i) + OB NVMe + 1x Retimer
84A-8	1 only												Y	N*	Y	Y	Y	N*	N	Y	(2x 5350-8i or 2x 9350-8i or 2x 4350-8i) + OB NVMe + 1x Retimer
84A-9	1 only												Y	N*	Y	Y	Y	N*	N	Y	2x (940-8i or 540-8i or 440-8i) + OB NVMe + 1x Retimer

Config	CPUs	Front		Mid			Rear			Backplanes	M.2				7mm				Supported controllers												
		SAS/SATA	AnyBay	NVMe	3.5" SAS/SATA	2.5" SAS/SATA	2.5" NVMe	3.5" SAS/SATA	2.5" SAS/SATA		2.5" NVMe	2.5" AnyBay	M.2 + VROC (SATA)	M.2 + VROC (NVMe)	M.2 + RAID adapter	M.2 RAID (NVMe)	7mm + VROC (SATA)	7mm + VROC (NVMe)		7mm + RAID adapter	7mm RAID (NVMe)										
84B-1	2 only	8	8	0	0	0	0	0	0	0	0	0	0	0	0	0	0	0	0	0	1x 8x2.5" SAS/SATA (B8LU) + 1x 8x2.5" AnyBay G5 (BLL2)	Y	Y	Y	Y	Y	Y	Y	Y	(9350-16i or 4350-16i) + OB NVMe + 1x Retimer	
84B-2	2 only																					Y	Y	Y	Y	Y	Y	Y	Y	(940-16i or 540-16i or 440-16i) + OB NVMe + 1x Retimer	
84B-3	2 only																					Y	Y	Y	Y	Y	Y	N	Y	(2x 5350-8i or 2x 9350-8i or 2x 4350-8i) + OB NVMe + 1x Retimer	
84B-4	2 only																					Y	Y	Y	Y	Y	Y	N	Y	2x (940-8i or 540-8i or 440-8i) + OB NVMe + 1x Retimer	
84B-5	2 only																					Y	Y	Y	Y	Y	Y	Y	Y	(9350-16i CFF or 940-16i CFF or 440-16i CFF) + OB NVMe + 1x Retimer	
85A-1	2 only	8	0	8	0	0	0	0	0	0	0	0	0	0	0	0	0	0	0	0	0	Y	Y	Y	Y	Y	Y	Y	Y	OB SATA + OB NVMe	
85A-2	2 only																					Y	Y	Y	Y	Y	Y	Y	Y	(5350-8i or 9350-8i or 4350-8i) + OB NVMe	
85A-3	2 only																					Y	Y	Y	Y	Y	Y	Y	Y	(940-8i or 540-8i or 440-8i) + OB NVMe	
85A-4	2 only																					Y	Y	Y	Y	Y	Y	Y	Y	(5350-8i CFF or 9350-8i CFF or 940-16i CFF or 440-16i CFF) + OB NVMe	
85A-5	1 or 2																					Y	Y*	Y	Y	Y	Y*	Y	Y	Y	OB SATA + OB NVMe
85A-6	1 or 2																					Y	Y*	Y	Y	Y	Y*	Y	Y	Y	(5350-8i or 9350-8i or 4350-8i) + OB NVMe
85A-7	1 or 2																					Y	Y*	Y	Y	Y	Y*	Y	Y	Y	(940-8i or 540-8i or 440-8i) + OB NVMe
85B-1	2 only	8	0	8	0	0	0	0	0	0	0	0	0	0	0	0	0	0	0	0	0	Y	Y	Y	Y	Y	Y	Y	Y	Y	OB SATA + OB NVMe
85B-2	2 only																					Y	Y	Y	Y	Y	Y	Y	Y	Y	(5350-8i or 9350-8i or 4350-8i) + OB NVMe
85B-3	2 only																					Y	Y	Y	Y	Y	Y	Y	Y	Y	(940-8i or 540-8i or 440-8i) + OB NVMe
85B-4	2 only																					Y	Y	Y	Y	Y	Y	Y	Y	Y	(5350-8i CFF or 9350-8i CFF or 940-16i CFF or 440-16i CFF) + OB NVMe
86A-1	2 only	16	8	0	0	0	0	0	0	0	0	0	0	0	0	0	0	0	0	0	0	Y	Y	Y	Y	Y	Y	Y	Y	Y	940-32i + OB NVMe
86A-2	2 only																					Y	Y	Y	Y	Y	Y	Y	Y	Y	(5350-8i or 9350-8i or 4350-8i) + OB NVMe + Exp-44i
86A-3	2 only																					Y	Y	Y	Y	Y	Y	Y	Y	Y	(940-8i or 540-8i or 440-8i) + OB NVMe + Exp-44i
86A-4	2 only																					Y	Y	Y	Y	Y	Y	Y	Y	Y	(9350-16i CFF or 940-16i CFF or 440-16i CFF) + OB NVMe + Exp-44i

Config	CPUs	Front		Mid			Rear			Backplanes	M.2				7mm				Supported controllers
		SAS/SATA	AnyBay	NVMe	3.5" SAS/SATA	2.5" SAS/SATA	2.5" NVMe	3.5" SAS/SATA	2.5" SAS/SATA		2.5" NVMe	2.5" AnyBay	M.2 + VROC (SATA)	M.2 + VROC (NVMe)	M.2 + RAID adapter	M.2 RAID (NVMe)	7mm + VROC (SATA)	7mm + VROC (NVMe)	
86A-5	2 only										Y	Y	N	Y	Y	Y	N	Y	3x (940-8i or 540-8i or 440-8i) + OB NVMe
86A-6	1 only										Y	N*	Y	Y	Y	N*	Y	Y	940-32i + OB NVMe
86A-7	1 only										Y	N*	Y	Y	Y	N*	Y	Y	(5350-8i or 9350-8i or 4350-8i) + OB NVMe + Exp-44i
86A-8	1 only										Y	N*	Y	Y	Y	N*	Y	Y	(940-8i or 540-8i or 440-8i) + OB NVMe + Exp-44i
86B-1	2 only	16	8	0	0	0	0	0	0	0	2x 8x2.5" SAS/SATA (B8LU) + 1x 8x2.5" AnyBay G5 (BLL2)	Y	Y	Y	Y	Y	Y	Y	940-32i + OB NVMe
86B-2	2 only											Y	Y	Y	Y	Y	Y	Y	(5350-8i or 9350-8i or 4350-8i) + OB NVMe + Exp-44i
86B-3	2 only											Y	Y	Y	Y	Y	Y	Y	(940-8i or 540-8i or 440-8i) + OB NVMe + Exp-44i
86B-4	2 only											Y	Y	Y	Y	Y	Y	Y	(9350-16i CFF or 940-16i CFF or 440-16i CFF) + OB NVMe + Exp-44i
86B-5	2 only											Y	Y	N	Y	Y	N	Y	3x (940-8i or 540-8i or 440-8i) + OB NVMe
87A-1	2 only	16	0	8	0	0	0	0	0	0	2x 8x2.5" SAS/SATA (B8LU) + 1x 8x2.5" NVMe G5 (BS7Y)	Y	Y	Y	Y	Y	N	Y	(9350-16i or 4350-16i) + OB NVMe
87A-2	2 only											Y	Y	Y	Y	Y	N	Y	(940-16i or 540-16i or 440-16i) + OB NVMe
87A-3	2 only											Y	Y	Y	Y	Y	Y	Y	(5350-8i or 9350-8i or 4350-8i) + OB NVMe + Exp-44i
87A-4	2 only											Y	Y	Y	Y	Y	Y	Y	(940-8i or 540-8i or 440-8i) + OB NVMe + Exp-44i
87A-5	1 only											Y	N*	Y	Y	Y	N*	Y	(5350-8i or 9350-8i or 4350-8i) + OB NVMe + Exp-44i
87A-6	1 only											Y	N*	Y	Y	Y	N*	Y	(940-8i or 540-8i or 440-8i) + OB NVMe + Exp-44i
87B-1	2 only	16	0	8	0	0	0	0	0	0	2x 8x2.5" SAS/SATA (B8LU) + 1x 8x2.5" NVMe G5 (BS7Y)	Y	Y	Y	Y	Y	Y	Y	(9350-16i or 4350-16i) + OB NVMe
87B-2	2 only											Y	Y	Y	Y	Y	Y	Y	(940-16i or 540-16i or 440-16i) + OB NVMe
87B-3	2 only											Y	Y	Y	Y	Y	Y	Y	(5350-8i or 9350-8i or 4350-8i) + OB NVMe + Exp-44i
87B-4	2 only											Y	Y	Y	Y	Y	Y	Y	(940-8i or 540-8i or 440-8i) + OB NVMe + Exp-44i
88-1	2 only	0	0	12	0	0	0	0	0	0	2x 8x2.5" NVMe G5 (BS7Y)	Y	Y	Y	Y	Y	Y	Y	OB NVMe

Config	CPUs	Front			Mid			Rear				Backplanes	M.2				7mm				Supported controllers
		SAS/SATA	AnyBay	NVMe	3.5" SAS/SATA	2.5" SAS/SATA	2.5" NVMe	3.5" SAS/SATA	2.5" SAS/SATA	2.5" NVMe	2.5" AnyBay		M.2 + VROC (SATA)	M.2 + VROC (NVMe)	M.2 + RAID adapter	M.2 RAID (NVMe)	7mm + VROC (SATA)	7mm + VROC (NVMe)	7mm + RAID adapter	7mm RAID (NVMe)	
89A-1	2 only	0	0	16	0	0	0	0	0	0	0	2x 8x2.5" NVMe G5 (BS7Y)	Y	Y	Y	Y	Y	Y	Y	Y	OB NVMe
89B-1	2 only	0	0	16	0	0	0	0	0	0	0	2x 8x2.5" NVMe G5 (BS7Y)	Y	N	Y	Y	Y	N	Y	Y	OB NVMe
89C-1	2 only	0	0	16	0	0	0	0	0	0	0	2x 8x2.5" NVMe G5 (BS7Y)	Y	Y	Y	Y	Y	Y	Y	Y	OB NVMe + 1x Retimer
90A-1	2 only	0	8	8	0	0	0	0	0	0	0	1x 8x2.5" AnyBay G5 (BLL2) + 1x 8x2.5" NVMe G5 (BS7Y)	Y	Y	Y	Y	Y	Y	Y	Y	(5350-8i or 9350-8i or 4350-8i) + OB NVMe
90A-2	2 only												Y	Y	Y	Y	Y	Y	Y	Y	(940-8i or 540-8i or 440-8i) + OB NVMe
90A-3	2 only												Y	Y	Y	Y	Y	Y	Y	Y	(5350-8i CFF or 9350-8i CFF or 940-16i CFF or 440-16i CFF) + OB NVMe
90B-1	2 only	0	8	8	0	0	0	0	0	0	0	1x 8x2.5" AnyBay G5 (BLL2) + 1x 8x2.5" NVMe G5 (BS7Y)	Y	N	Y	Y	Y	N	Y	Y	(5350-8i or 9350-8i or 4350-8i) + OB NVMe
90B-2	2 only												Y	N	Y	Y	Y	N	Y	Y	(940-8i or 540-8i or 440-8i) + OB NVMe
90C-1	2 only	0	8	8	0	0	0	0	0	0	0	1x 8x2.5" AnyBay G5 (BLL2) + 1x 8x2.5" NVMe G5 (BS7Y)	Y	Y	Y	Y	Y	Y	Y	Y	(5350-8i or 9350-8i or 4350-8i) + OB NVMe + 1x Retimer
90C-2	2 only												Y	Y	Y	Y	Y	Y	Y	Y	(940-8i or 540-8i or 440-8i) + OB NVMe + 1x Retimer
91A-1	2 only	8	0	16	0	0	0	0	0	0	0	1x 8x2.5" SAS/SATA (B8LU) + 2x 8x2.5" NVMe G5 (BS7Y)	Y	Y	Y	Y	Y	Y	Y	Y	(5350-8i or 9350-8i or 4350-8i) + OB NVMe
91A-2	2 only												Y	Y	Y	Y	Y	Y	Y	Y	(940-8i or 540-8i or 440-8i) + OB NVMe
91B-1	2 only	8	0	16	0	0	0	0	0	0	0	1x 8x2.5" SAS/SATA (B8LU) + 2x 8x2.5" NVMe G5 (BS7Y)	Y	Y	Y	Y	Y	Y	Y	Y	(5350-8i or 9350-8i or 4350-8i) + OB NVMe + 1x Retimer
91B-2	2 only												Y	Y	Y	Y	Y	Y	Y	Y	(940-8i or 540-8i or 440-8i) + OB NVMe + 1x Retimer
92-1	2 only	4	12	0	0	0	0	0	0	0	0	2x 8x2.5" AnyBay G5 (BLL2)	Y	Y	Y	Y	Y	Y	Y	Y	(9350-16i or 4350-16i) + OB NVMe
92-2	2 only												Y	Y	Y	Y	Y	Y	Y	Y	(940-16i or 540-16i or 440-16i) + OB NVMe
93A-1	2 only	0	16	0	0	0	0	0	0	0	0	2x 8x2.5" AnyBay G5 (BLL2)	Y	Y	Y	Y	Y	Y	Y	Y	(9350-16i or 4350-16i) + OB NVMe
93A-2	2 only												Y	Y	Y	Y	Y	Y	Y	Y	(940-16i or 540-16i or 440-16i) + OB NVMe
93B-1	2 only	0	16	0	0	0	0	0	0	0	0	2x 8x2.5" AnyBay G5 (BLL2)	Y	N	Y	Y	Y	N	Y	Y	(9350-16i or 4350-16i) + OB NVMe
93B-2	2 only												Y	N	Y	Y	Y	N	Y	Y	(940-16i or 540-16i or 440-16i) + OB NVMe
93C-1	2 only	0	16	0	0	0	0	0	0	0	0	2x 8x2.5" AnyBay G5 (BLL2)	Y	Y	Y	Y	Y	Y	Y	Y	(9350-16i or 4350-16i) + OB NVMe + 1x Retimer

Config	CPUs	Front		Mid			Rear			Backplanes	M.2				7mm				Supported controllers		
		SAS/SATA	AnyBay NVMe	3.5" SAS/SATA	2.5" SAS/SATA	2.5" NVMe	3.5" SAS/SATA	2.5" SAS/SATA	2.5" NVMe		2.5" AnyBay	M.2 + VROC (SATA)	M.2 + VROC (NVMe)	M.2 + RAID adapter	M.2 RAID (NVMe)	7mm + VROC (SATA)	7mm + VROC (NVMe)	7mm + RAID adapter		7mm RAID (NVMe)	
93C-2	2 only																		(940-16i or 540-16i or 440-16i) + OB NVMe + 1x Retimer		
93D-1	2 only	0	16	0	0	0	0	0	0	0	2x 8x2.5" AnyBay G5 (BLL2)	Y	Y	Y	Y	Y	Y	Y	(9350-16i or 4350-16i) + OB NVMe + 1x Retimer		
93D-2	2 only											Y	Y	Y	Y	Y	Y	Y	(940-16i or 540-16i or 440-16i) + OB NVMe + 1x Retimer		
94A-1	2 only	0	0	24	0	0	0	0	0	0	3x 8x2.5" NVMe G5 (BS7Y)	Y	N	Y	Y	Y	N	Y	Y	OB NVMe + 1x Retimer	
94B-1	2 only	0	0	24	0	0	0	0	0	0	3x 8x2.5" NVMe G5 (BS7Y)	Y	Y	N	Y	Y	Y	N	Y	OB NVMe + 2x Retimer	
95A-1	2 only	0	8	16	0	0	0	0	0	0	1x 8x2.5" AnyBay G5 (BLL2) + 2x 8x2.5" NVMe G5 (BS7Y)	Y	N	Y	Y	Y	N	N	Y	(5350-8i or 9350-8i or 4350-8i) + OB NVMe + 1x Retimer	
95A-2	2 only											Y	N	Y	Y	Y	N	N	Y	(940-8i or 540-8i or 440-8i) + OB NVMe + 1x Retimer	
95B-1	2 only	0	8	16	0	0	0	0	0	0	1x 8x2.5" AnyBay G5 (BLL2) + 2x 8x2.5" NVMe G5 (BS7Y)	Y	Y	N	Y	Y	Y	N	Y	(5350-8i or 9350-8i or 4350-8i) + OB NVMe + 2x Retimer	
95B-2	2 only											Y	Y	N	Y	Y	Y	N	Y	(940-8i or 540-8i or 440-8i) + OB NVMe + 2x Retimer	
96-1	2 only	16	8	0	0	0	0	0	4	0	Front: 2x 8x2.5" SAS/SATA (B8LU) + 1x 8x2.5" AnyBay G5 (BLL2); Rear: 4x2.5" SAS/SATA (B8LV)	Y	Y	Y	Y	N	N	N	N	940-32i + OB NVMe	
96-2	2 only											Y	Y	Y	Y	N	N	N	N	(5350-8i or 9350-8i or 4350-8i) + OB NVMe + Exp-44i	
96-3	2 only											Y	Y	Y	Y	N	N	N	N	(940-8i or 540-8i or 440-8i) + OB NVMe + Exp-44i	
96-4	2 only											Y	Y	Y	Y	N	N	N	N	(9350-16i CFF or 940-16i CFF or 440-16i CFF) + OB NVMe + Exp-44i	
96-5	2 only											Y	Y	N	Y	N	N	N	N	4x (5350-8i or 9350-8i or 4350-8i) + OB NVMe	
96-6	2 only											Y	Y	N	Y	N	N	N	N	4x (940-8i or 540-8i or 440-8i) + OB NVMe	
98-1	2 only	0	0	24	0	0	0	0	0	4	0	Front: 3x 8x2.5" NVMe G5 (BS7Y); Rear: 1x 4x2.5" NVMe G5 (BQZM)	Y	Y	N	Y	Y	Y	N	Y	OB NVMe + 3x Retimer
103-1	2 only	0	0	24	0	0	8	0	0	0	0	Front: 3x 8x2.5" NVMe G5 (BS7Y); Mid: 2x 4x2.5" NVMe G5 (BS81)	Y	N	N	Y	Y	N	N	Y	Front: OB NVMe + Retimer; Mid: 2x Retimer

Config	CPUs	Front			Mid			Rear			Backplanes	M.2				7mm				Supported controllers	
		SAS/SATA	AnyBay	NVMe	3.5" SAS/SATA	2.5" SAS/SATA	2.5" NVMe	3.5" SAS/SATA	2.5" SAS/SATA	2.5" NVMe		2.5" AnyBay	M.2 + VROC (SATA)	M.2 + VROC (NVMe)	M.2 + RAID adapter	M.2 RAID (NVMe)	7mm + VROC (SATA)	7mm + VROC (NVMe)	7mm + RAID adapter		7mm RAID (NVMe)
104-1	2 only	0	0	24	0	0	8	0	0	4	0	Front: 3x 8x2.5" NVMe G5 (BS7Y); Mid: 2x 4x2.5" NVMe G5 (BS81); Rear: 1x 4x2.5" NVMe G5 (BQZM)	Y	N	N	Y	Y	N	N	Y	Front: OB NVMe + Retimer; Mid: 2x Retimer; Rear: Retimer
105-1	1 or 2	0	8	0	0	0	0	0	0	0	0	1x 8x2.5" AnyBay G5 (BLL2)	Y	Y	Y	Y	Y	Y	Y	Y	940-8i Tri-mode
106-1	1 or 2	0	16	0	0	0	0	0	0	0	0	2x 8x2.5" AnyBay G5 (BLL2)	Y	Y*	Y	Y	Y	Y*	Y	Y	940-16i Tri-mode
106-2	1 or 2	0	16	0	0	0	0	0	0	0	0	2x 8x2.5" AnyBay G5 (BLL2)	Y	Y*	Y	Y	Y	Y*	Y	Y	2x 940-8i Tri-mode
107-1	1 or 2	8	16	0	0	0	0	0	0	0	0	1x 8x2.5" SAS/SATA (B8LU) + 2x 8x2.5" AnyBay G5 (BLL2)	Y	Y	Y	Y	Y	Y	Y	Y	(940-8i or 540-8i or 440-8i) + 940-16i Tri-mode
108-1	1 or 2	0	24	0	0	0	0	0	0	0	0	3x 8x2.5" AnyBay G5 (BLL2)	Y	Y	Y	Y	Y	Y	Y	Y	940-16i Tri-mode + 940-8i Tri-mode
108-2	1 or 2	0	24	0	0	0	0	0	0	0	0	3x 8x2.5" AnyBay G5 (BLL2)	Y	Y	N	Y	Y	Y	N	Y	3x 940-8i Tri-mode

* For M.2 or 7mm: Requires 2 processors; 1P not supported

Details - 2.5-inch front drives supporting 12 PCIe slots (front & rear)

The following table details the configurations that use 2.5-inch front drives supporting 12 PCIe slots (front & rear). Such a configuration supports up to 16x 2.5-inch drive bays + PCIe slots at the front of the server.

Click to go to the [overview of the 2.5-inch front drive configurations](#).

Return to [Storage configurations](#).

In the table:

- **M.2 + VROC (SATA)** means the M.2 SATA/x4 NVMe adapter (4Y37A79663) with SATA drives. RAID is optional, provided using VROC.
- **M.2 + VROC (NVMe)** means the M.2 SATA/x4 NVMe adapter (4Y37A79663) with NVMe drives. RAID is optional, provided using VROC.
- **M.2 + RAID adapter** means the M.2 SATA/x4 NVMe adapter (4Y37A79663) with either a RAID 5350-8i adapter (supporting SATA drives) or a RAID 540-8i (supporting NVMe drives)
- **M.2 RAID (NVMe)** means the M.2 RAID NVMe adapter (B8P9) with NVMe drives. SATA drives not supported. RAID-0 and RAID-1 are supported with the integrated Marvell RAID controller.
- **7mm + VROC (SATA)** means the 7mm SATA/NVMe kit (BU0N) with SATA drives. RAID is optional, provided using VROC.
- **7mm + VROC (NVMe)** means the 7mm SATA/NVMe kit (BU0N) with NVMe drives. RAID is optional, provided using VROC.
- **7mm + RAID adapter** means the 7mm SATA/NVMe kit (BU0N) with either a RAID 5350-8i adapter (supporting SATA drives) or a RAID 540-8i (supporting NVMe drives)
- **7mm RAID (NVMe)** means the 7mm NVMe RAID kit (B8P3) with NVMe drives. SATA drives not supported. RAID-0 and RAID-1 are supported with the integrated Marvell RAID controller.

Tip: M.2 and 7mm are mutually exclusive: they are not supported together in the same configuration

Table 35. Details - 2.5-inch front drives supporting 12 PCIe slots (front & rear)

Config	CPUs	Front			Mid			Rear				Backplanes	M.2				7mm				Supported controllers	
		SAS/SATA	AnyBay	NVMe	3.5" SAS/SATA	2.5" SAS/SATA	2.5" NVMe	3.5" SAS/SATA	2.5" SAS/SATA	2.5" NVMe	2.5" AnyBay		M.2 + VROC (SATA)	M.2 + VROC (NVMe)	M.2 + RAID adapter	M.2 RAID (NVMe)	7mm + VROC (SATA)	7mm + VROC (NVMe)	7mm + RAID adapter	7mm RAID (NVMe)		
31-1	1 or 2	8	0	0	0	0	0	0	0	0	0	1x 8x2.5" SAS/SATA (B8LU)	Y	Y	Y	Y	Y	Y	Y	Y	Y	OB SATA + OB NVMe
31-2	1 or 2													Y	Y	Y	Y	Y	Y	Y	Y	(5350-8i or 9350-8i or 4350-8i) + OB NVMe
31-3	1 or 2													Y	Y	Y	Y	Y	Y	Y	Y	(940-8i or 540-8i or 440-8i) + OB NVMe
31-4	1 or 2													Y	Y	Y	Y	Y	Y	Y	Y	(9350-16i or 4350-16i) + OB NVMe
31-5	1 or 2													Y	Y	Y	Y	Y	Y	Y	Y	(940-16i or 540-16i or 440-16i) + OB NVMe
32-1	2 only	0	8	0	0	0	0	0	0	0	0	1x 8x2.5" AnyBay G4 (BH8B)	Y	N	Y	Y	Y	N	Y	Y	Y	(5350-8i or 9350-8i or 4350-8i) + OB NVMe
32-2	2 only													Y	N	Y	Y	Y	N	Y	Y	(940-8i or 540-8i or 440-8i) + OB NVMe
32-3	2 only													Y	N	Y	Y	Y	N	Y	Y	(9350-16i or 4350-16i) + OB NVMe
32-4	2 only													Y	N	Y	Y	Y	N	Y	Y	(940-16i or 540-16i or 440-16i) + OB NVMe
33-1	1 or 2	0	8	0	0	0	0	0	0	0	0	1x 8x2.5" AnyBay G4 (BH8B)	Y	Y	Y	Y	Y	Y	Y	Y	Y	940-8i Tri-mode
34-1	2 only	0	0	8	0	0	0	0	0	0	0	1x 8x2.5" NVMe G4 (BH8D)	Y	N	Y	Y	Y	N	Y	Y	Y	OB NVMe
35-1	1 or 2	16	0	0	0	0	0	0	0	0	0	2x 8x2.5" SAS/SATA (B8LU)	Y	Y	Y	Y	Y	Y	Y	Y	Y	(9350-16i or 4350-16i) + OB NVMe
35-2	1 or 2													Y	Y	Y	Y	Y	Y	Y	Y	(940-16i or 540-16i or 440-16i) + OB NVMe
35-3	1 or 2													Y	Y	Y	Y	Y	N	Y	Y	(2x 5350-8i or 2x 9350-8i or 2x 4350-8i) + OB NVMe
35-4	1 or 2													Y	Y	Y	Y	Y	N	Y	Y	2x (940-8i or 540-8i or 440-8i) + OB NVMe
36-1	2 only	8	8	0	0	0	0	0	0	0	0	1x 8x2.5" SAS/SATA (B8LU) + 1x 8x2.5" AnyBay G4 (BH8B)	Y	N	Y	Y	Y	N	Y	Y	Y	(9350-16i or 4350-16i) + OB NVMe
36-2	2 only													Y	N	Y	Y	Y	N	Y	Y	(940-16i or 540-16i or 440-16i) + OB NVMe
36-3	2 only													Y	N	Y	Y	Y	N	N	Y	(2x 5350-8i or 2x 9350-8i or 2x 4350-8i) + OB NVMe
36-4	2 only													Y	N	Y	Y	Y	N	N	Y	2x (940-8i or 540-8i or 440-8i) + OB NVMe
37-1	2 only	8	0	8	0	0	0	0	0	0	0	1x 8x2.5" SAS/SATA (B8LU) + 1x 8x2.5" NVMe G4 (BH8D)	Y	N	Y	Y	Y	N	Y	Y	Y	OB SATA + OB NVMe
37-2	2 only													Y	N	Y	Y	Y	N	Y	Y	(5350-8i or 9350-8i or 4350-8i) + OB NVMe

Config	CPUs	Front		Mid		Rear				Backplanes	M.2				7mm				Supported controllers	
		SAS/SATA	AnyBay			NVMe	3.5" SAS/SATA				2.5" SAS/SATA	2.5" NVMe	3.5" SAS/SATA	2.5" SAS/SATA	2.5" NVMe	2.5" AnyBay	M.2 + VROC (SATA)	M.2 + VROC (NVMe)		M.2 + RAID adapter
37-3	2 only										Y	N	Y	Y	Y	N	Y	Y	(940-8i or 540-8i or 440-8i) + OB NVMe	
38-1	2 only	0	0	16	0	0	0	0	0	0	0	0	0	0	0	0	0	0	2x 8xNVMe G4 (BH8D)	OB NVMe + 2x Retimer
39-1	1 or 2	0	16	0	0	0	0	0	0	0	0	0	0	0	0	0	0	0	2x 8x2.5" AnyBay G4 (BH8B)	940-16i Tri-mode
39-2	1 or 2										Y	Y	Y	Y	Y	Y	N	Y	2x 940-8i Tri-mode	
40-1	1 or 2	14	0	0	0	0	0	0	0	0	N	Y	Y	N	N	Y	Y	N	2x 8x2.5" SAS/SATA (B8LU) (14 bays max)	OB SATA + OB NVMe
100-1	2 only	0	8	0	0	0	0	0	0	0	Y	N	Y	Y	Y	N	Y	Y	1x 8x2.5" AnyBay G5 (BLL2)	(5350-8i or 9350-8i or 4350-8i) + OB NVMe
100-2	2 only										Y	N	Y	Y	Y	N	Y	Y		(940-8i or 540-8i or 440-8i) + OB NVMe
100-3	2 only										Y	N	Y	Y	Y	N	Y	Y		(9350-16i or 4350-16i) + OB NVMe
100-4	2 only										Y	N	Y	Y	Y	N	Y	Y		(940-16i or 540-16i or 440-16i) + OB NVMe
101-1	2 only	0	0	8	0	0	0	0	0	0	Y	N	Y	Y	Y	N	Y	Y	1x 8x2.5" NVMe G5 (BS7Y)	OB NVMe
102-1	2 only	0	0	16	0	0	0	0	0	0	Y	N	Y	Y	Y	N	Y	Y	2x 8x2.5" NVMe G5 (BS7Y)	OB NVMe + 2x Retimer
109-1	1 or 2	0	8	0	0	0	0	0	0	0	Y	Y	Y	Y	Y	Y	Y	Y	1x 8x2.5" AnyBay G5 (BLL2)	940-8i Tri-mode
110-1	1 or 2	0	16	0	0	0	0	0	0	0	Y	Y	Y	Y	Y	Y	Y	Y	2x 8x2.5" AnyBay G5 (BLL2)	940-16i Tri-mode
110-2	1 or 2										Y	Y	Y	Y	Y	N	Y	Y		2x 940-8i Tri-mode

* For M.2 or 7mm: Requires 2 processors; 1P not supported

Field upgrades

The SR650 V3 is orderable without drive bays, allowing you to add a backplane, cabling and controllers as field upgrades. The server also supports upgrading some configurations by adding additional front drive bays (for example, upgrading from 8 to 16x 2.5-inch drive bays).

Upgrade path: The key criteria for upgrade support is to ensure that the target configuration is one of the supported drive bay configurations as listed in the [Supported drive bay combinations](#) section.

For example, if you are upgrading a 2.5-inch SAS/SATA drive configuration from 8 bays (Config 9) to 16 bays (Config 12), you will need these additional options:

- 4XH7A60930, ThinkSystem V3 2U 8x2.5" SAS/SATA Backplane Option Kit
- 4X97A82935, ThinkSystem SR650 V3 2.5" Chassis Front BP2 SAS/SATA Cable Kit

To add drive bays you will need to order both drive backplanes and cable kits. Backplane kits do not include cables.

In this section:

- [Drive bay field upgrades - 3.5-inch chassis](#)

- Drive bay field upgrades - 2.5-inch chassis with SAS/SATA and Gen4 front bays
- Drive bay field upgrades - 2.5-inch chassis with Gen5 front bays
- Drive bay field upgrades - 2.5-inch chassis with front slots
- Upgrading to an internal (CFF) adapter
- 2.5-inch drive bay fillers

Drive bay field upgrades - 3.5-inch chassis

The table below lists the backplane kits and cable kits needed to build one of the supported 3.5-inch chassis configurations.

The Config numbers listed here match the configuration listed in the Storage configuration [Overview](#) and [Details](#) sections.

Return to [Field upgrades](#).

For more information about the backplane kits and cable kits, see the Lenovo server options site: https://serveroption.lenovo.com/cable_kit_options/

Table 36. Drive bay field upgrade for the 3.5-inch chassis (Blue = SAS/SATA, Purple = AnyBay, Red = NVMe)

Config	3.5" front bays			Mid bays			Rear bays				Backplane and cable kits required (all required)
	SAS/SATA	Any Bay	NVMe	3.5" SAS	2.5" SAS	2.5" NVMe	3.5" SAS	2.5" SAS	2.5" NVMe	2.5" Any	
1	8	0	0	0	0	0	0	0	0	0	<ul style="list-style-type: none"> • 4XH7A60932, ThinkSystem SR650 V2/SR665 8x3.5" SAS/SATA Backplane Option Kit • 4X97A87506, ThinkSystem SR650 V2 SAS/SATA Cable from MB to Front 3.5" BP SATA0/1
2	12	0	0	0	0	0	0	0	0	0	<ul style="list-style-type: none"> • 4XH7A60929, ThinkSystem V2/V3 2U 12x3.5" SAS/SATA Backplane Option Kit • 4X97A82928, ThinkSystem SR650 V3 3.5" Chassis Front Backplane SAS/SATA Cable Kit
3	12	0	0	0	0	0	2	0	0	0	<ul style="list-style-type: none"> • 4XH7A60929, ThinkSystem V2/V3 2U 12x3.5" SAS/SATA Backplane Option Kit • 4XH7A60940, ThinkSystem SR650 V2/SR665 Rear 2x3.5" SAS/SATA Backplane Option Kit • 4X97A82928, ThinkSystem SR650 V3 3.5" Chassis Front Backplane SAS/SATA Cable Kit • 4X97A82930, ThinkSystem SR650 V3 3.5" Chassis Rear Backplane SAS/SATA Cable Kit
4	12	0	0	0	0	0	4	0	0	0	<ul style="list-style-type: none"> • 4XH7A60929, ThinkSystem V2/V3 2U 12x3.5" SAS/SATA Backplane Option Kit • 4XH7A60939, ThinkSystem V2/V3 2U Rear 4x3.5" SAS/SATA Rear Backplane Option Kit • 4X97A82928, ThinkSystem SR650 V3 3.5" Chassis Front Backplane SAS/SATA Cable Kit • 4X97A82930, ThinkSystem SR650 V3 3.5" Chassis Rear Backplane SAS/SATA Cable Kit

Config	3.5" front bays			Mid bays			Rear bays				Backplane and cable kits required (all required)
	SAS/SATA	Any Bay	NVMe	3.5" SAS	2.5" SAS	2.5" NVMe	3.5" SAS	2.5" SAS	2.5" NVMe	2.5" Any	
6	12	0	0	4	0	0	4	0	0	0	<ul style="list-style-type: none"> • 4XH7A60929, ThinkSystem V2/V3 2U 12x3.5" SAS/SATA Backplane Option Kit • 4XH7A82916, ThinkSystem SR650 V3 Middle 4x3.5" SAS/SATA Backplane Option Kit • 4XH7A60939, ThinkSystem V2/V3 2U Rear 4x3.5" SAS/SATA Rear Backplane Option Kit • 4X97A82928, ThinkSystem SR650 V3 3.5" Chassis Front Backplane SAS/SATA Cable Kit • 4X97A82931, ThinkSystem SR650 V3 3.5" Chassis Middle Backplane SAS/SATA Cable Kit • 4X97A82930, ThinkSystem SR650 V3 3.5" Chassis Rear Backplane SAS/SATA Cable Kit
5	12	0	0	0	0	0	0	4	0	0	<ul style="list-style-type: none"> • 4XH7A60929, ThinkSystem V2/V3 2U 12x3.5" SAS/SATA Backplane Option Kit • 4XH7A60938, ThinkSystem V3 2U 4x2.5" SAS/SATA Rear Backplane Option Kit • 4X97A82928, ThinkSystem SR650 V3 3.5" Chassis Front Backplane SAS/SATA Cable Kit • 4X97A82938, ThinkSystem SR650 V3 2.5" Chassis Rear Backplane SAS/SATA Cable Kit
54	12	0	0	0	0	0	0	0	0	4	<ul style="list-style-type: none"> • 4XH7A60929, ThinkSystem V2/V3 2U 12x3.5" SAS/SATA Backplane Option Kit • 4XH7A87545, ThinkSystem 2U V3 Rear 4x2.5" Gen5 NVMe Backplane Option Kit • 4X97A82928, ThinkSystem SR650 V3 3.5" Chassis Front Backplane SAS/SATA Cable Kit • 4X97A82938, ThinkSystem SR650 V3 2.5" Chassis Rear Backplane SAS/SATA Cable Kit • 4X97A87062, ThinkSystem SR650 V3 2.5" Chassis Rear Backplane NVMe Cable Kit
6A	12	0	0	4	0	0	0	0	0	0	<ul style="list-style-type: none"> • 4XH7A60929, ThinkSystem V2/V3 2U 12x3.5" SAS/SATA Backplane Option Kit • 4XH7A82916, ThinkSystem SR650 V3 Middle 4x3.5" SAS/SATA Backplane Option Kit • 4X97A82928, ThinkSystem SR650 V3 3.5" Chassis Front Backplane SAS/SATA Cable Kit • 4X97A82939, ThinkSystem SR650 V3 2.5" Chassis Middle Backplane SAS/SATA Cable Kit
6B	12	0	0	0	4	0	0	0	0	0	<ul style="list-style-type: none"> • 4XH7A60929, ThinkSystem V2/V3 2U 12x3.5" SAS/SATA Backplane Option Kit • 4XH7A87509, ThinkSystem SR650 V3 Middle 4x2.5" SAS/SATA Backplane Option Kit • 4X97A82928, ThinkSystem SR650 V3 3.5" Chassis Front Backplane SAS/SATA Cable Kit • 4X97A82939, ThinkSystem SR650 V3 2.5" Chassis Middle Backplane SAS/SATA Cable Kit

Config	3.5" front bays			Mid bays			Rear bays				Backplane and cable kits required (all required)
	SAS/SATA	Any Bay	NVMe	3.5" SAS	2.5" SAS	2.5" NVMe	3.5" SAS	2.5" SAS	2.5" NVMe	2.5" Any	
26	12	0	0	0	0	8	0	0	0	0	<ul style="list-style-type: none"> • 4XH7A60929, ThinkSystem V2/V3 2U 12x3.5" SAS/SATA Backplane Option Kit • 4XH7A82915, ThinkSystem SR650 V3 Middle 8x2.5" NVMe Backplane Option Kit • 4X97A59804, ThinkSystem SR650 V2 3.5" Chassis Front Backplane SAS/SATA Cable Kit • 4X97A82940, ThinkSystem SR650 V3 2.5" Chassis Middle Backplane NVMe Cable Kit
7B	8	0	4	0	0	0	0	0	0	0	<ul style="list-style-type: none"> • 4XH7A87508, ThinkSystem V3 2U 8xSAS/SATA+4xNVMe 3.5" Backplane Option Kit • 4X97A82928, ThinkSystem SR650 V3 3.5" Chassis Front Backplane SAS/SATA Cable Kit • 4X97A87504, ThinkSystem SR650 V3 4x3.5" Chassis Front Backplane NVMe Cable Kit
8B	8	0	4	0	0	0	4	0	0	0	<ul style="list-style-type: none"> • 4XH7A87508, ThinkSystem V3 2U 8xSAS/SATA+4xNVMe 3.5" Backplane Option Kit • 4XH7A60939, ThinkSystem V2/V3 2U Rear 4x3.5" SAS/SATA Rear Backplane Option Kit • 4X97A82928, ThinkSystem SR650 V3 3.5" Chassis Front Backplane SAS/SATA Cable Kit • 4X97A87504, ThinkSystem SR650 V3 4x3.5" Chassis Front Backplane NVMe Cable Kit • 4X97A59806, ThinkSystem SR650 V2 3.5" Chassis Rear Backplane SAS/SATA Cable Kit
7A	8	4	0	0	0	0	0	0	0	0	<ul style="list-style-type: none"> • 4XH7A87507, ThinkSystem V3 2U 8xSAS/SATA+4xAnyBay 3.5" Backplane Option Kit • 4X97A82928, ThinkSystem SR650 V3 3.5" Chassis Front Backplane SAS/SATA Cable Kit • 4X97A87504, ThinkSystem SR650 V3 4x3.5" Chassis Front Backplane NVMe Cable Kit
8A	8	4	0	0	0	0	4	0	0	0	<ul style="list-style-type: none"> • 4XH7A87507, ThinkSystem V3 2U 8xSAS/SATA+4xAnyBay 3.5" Backplane Option Kit • 4XH7A60939, ThinkSystem V2/V3 2U Rear 4x3.5" SAS/SATA Rear Backplane Option Kit • 4X97A82928, ThinkSystem SR650 V3 3.5" Chassis Front Backplane SAS/SATA Cable Kit • 4X97A87504, ThinkSystem SR650 V3 4x3.5" Chassis Front Backplane NVMe Cable Kit • 4X97A59806, ThinkSystem SR650 V2 3.5" Chassis Rear Backplane SAS/SATA Cable Kit
42	12-EXP	0	0	0	0	0	0	0	0	0	<ul style="list-style-type: none"> • 4XH7A86133, ThinkSystem SR665 V3/SR655 V3 12x3.5" Expander Backplane Option Kit • 4X97A87505, ThinkSystem SR650 V3 3.5"/2.5" Chassis Front Expander Backplane SAS/SATA Cable Kit

Config	3.5" front bays			Mid bays			Rear bays				Backplane and cable kits required (all required)
	SAS/SATA	Any Bay	NVMe	3.5" SAS	2.5" SAS	2.5" NVMe	3.5" SAS	2.5" SAS	2.5" NVMe	2.5" Any	
43	12-EXP	0	0	0	0	0	4	0	0	0	<ul style="list-style-type: none"> • 4XH7A86133, ThinkSystem SR665 V3/SR655 V3 12x3.5" Expander Backplane Option Kit • 4XH7A60939, ThinkSystem V2/V3 2U Rear 4x3.5" SAS/SATA Rear Backplane Option Kit • 4X97A87505, ThinkSystem SR650 V3 3.5"/2.5" Chassis Front Expander Backplane SAS/SATA Cable Kit • 4X97A82930, ThinkSystem SR650 V3 3.5" Chassis Rear Backplane SAS/SATA Cable Kit
44	12-EXP	0	0	0	0	0	0	0	0	4	<ul style="list-style-type: none"> • 4XH7A86133, ThinkSystem SR665 V3/SR655 V3 12x3.5" Expander Backplane Option Kit • 4XH7A87545, ThinkSystem 2U V3 Rear 4x2.5" Gen5 NVMe Backplane Option Kit • 4X97A87505, ThinkSystem SR650 V3 3.5"/2.5" Chassis Front Expander Backplane SAS/SATA Cable Kit • 4X97A82938, ThinkSystem SR650 V3 2.5" Chassis Rear Backplane SAS/SATA Cable Kit • 4X97A87062, ThinkSystem SR650 V3 2.5" Chassis Rear Backplane NVMe Cable Kit
45	12-EXP	0	0	0	0	0	2	0	0	0	<ul style="list-style-type: none"> • 4XH7A86133, ThinkSystem SR665 V3/SR655 V3 12x3.5" Expander Backplane Option Kit • 4XH7A82918, ThinkSystem V3 2U Rear 4x3.5" SAS/SATA Backplane Option Kit • 4X97A87505, ThinkSystem SR650 V3 3.5"/2.5" Chassis Front Expander Backplane SAS/SATA Cable Kit • 4X97A82930, ThinkSystem SR650 V3 3.5" Chassis Rear Backplane SAS/SATA Cable Kit
46	12-EXP	0	0	4	0	0	4	0	0	0	<ul style="list-style-type: none"> • 4XH7A86133, ThinkSystem SR665 V3/SR655 V3 12x3.5" Expander Backplane Option Kit • 4XH7A82916, ThinkSystem SR650 V3 Middle 4x3.5" SAS/SATA Backplane Option Kit • 4XH7A60939, ThinkSystem V2/V3 2U Rear 4x3.5" SAS/SATA Rear Backplane Option Kit • 4X97A87505, ThinkSystem SR650 V3 3.5"/2.5" Chassis Front Expander Backplane SAS/SATA Cable Kit • 4X97A82931, ThinkSystem SR650 V3 3.5" Chassis Middle Backplane SAS/SATA Cable Kit • 4X97A82930, ThinkSystem SR650 V3 3.5" Chassis Rear Backplane SAS/SATA Cable Kit
99	12	0	0	0	0	8	0	0	0	0	<ul style="list-style-type: none"> • 4XH7A60929, ThinkSystem V2/V3 2U 12x3.5" SAS/SATA Backplane Option Kit • 4XH7A90334, ThinkSystem V3 2U Middle 8x2.5" Gen5 NVMe Backplane Option Kit • 4X97A59804, ThinkSystem SR650 V2 3.5" Chassis Front Backplane SAS/SATA Cable Kit • 4X97A90338, ThinkSystem SR650 V3 2.5" Chassis Rear Backplane NVMe Cable Kit

Drive bay field upgrades - 2.5-inch chassis with SAS/SATA and Gen4 front bays

The tables below lists the backplane kits and cable kits needed to build one of the supported 2.5-inch chassis configurations with either SAS/SATA or Gen4 front backplanes.

The Config numbers listed here match the configuration listed in the Storage configuration [Overview](#) and [Details](#) sections.

Return to [Field upgrades](#).

Note: Front drive cable kits are based on the location of the backplane in the server. The three backplane locations are BP1, BP2 and BP3 as shown in the following figure.

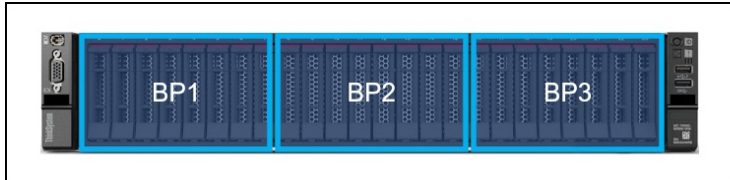

Figure 15. Backplane numbering

For more information about the backplane kits and cable kits, see the Lenovo server options site: https://serveroption.lenovo.com/cable_kit_options/

Table 37. Drive bay field upgrade for the 2.5-inch chassis (SAS/SATA and Gen4 NVMe/AnyBay) (Blue = SAS/SATA, Purple = AnyBay, Red = NVMe)

Config	2.5" front bays				Mid bays			Rear bays				Backplane and cable kits required (all required)
	SAS/SATA	Any Bay	NVMe	Tri-Mode	3.5" SAS	2.5" SAS	2.5" NVMe	3.5" SAS	2.5" SAS	2.5" NVMe	2.5" Any	
9	8	0	0	0	0	0	0	0	0	0	0	<ul style="list-style-type: none"> 4XH7A60930, ThinkSystem V3 2U 8x2.5" SAS/SATA Backplane Option Kit 4X97A82933, ThinkSystem SR650 V3 2.5" Chassis Front BP1 SAS/SATA Cable Kit
10	0	8	0	0	0	0	0	0	0	0	0	<ul style="list-style-type: none"> 4XH7A82913, ThinkSystem SR650 V3 8x2.5" AnyBay Backplane Option Kit 4X97A82933, ThinkSystem SR650 V3 2.5" Chassis Front BP1 SAS/SATA Cable Kit 4X97A82932, ThinkSystem SR650 V3 2.5" Chassis Front BP1 NVMe Cable Kit
11	0	0	8	0	0	0	0	0	0	0	0	<ul style="list-style-type: none"> 4XH7A61076, ThinkSystem V2/V3 2U 8x2.5" NVMe Backplane Option Kit 4X97A82932, ThinkSystem SR650 V3 2.5" Chassis Front BP1 NVMe Cable Kit
41	0	0	0	8	0	0	0	0	0	0	0	<ul style="list-style-type: none"> 4XH7A82913, ThinkSystem SR650 V3 8x2.5" AnyBay Backplane Option Kit 4X97A82933, ThinkSystem SR650 V3 2.5" Chassis Front BP1 SAS/SATA Cable Kit
27	14	0	0	0	0	0	0	0	0	0	0	<ul style="list-style-type: none"> 4XH7A60930, ThinkSystem V3 2U 8x2.5" SAS/SATA Backplane Option Kit 4XH7A60930, ThinkSystem V3 2U 8x2.5" SAS/SATA Backplane Option Kit 4X97A82933, ThinkSystem SR650 V3 2.5" Chassis Front BP1 SAS/SATA Cable Kit 4X97A82935, ThinkSystem SR650 V3 2.5" Chassis Front BP2 SAS/SATA Cable Kit

Config	2.5" front bays				Mid bays			Rear bays				Backplane and cable kits required (all required)
	SAS/SATA	Any Bay	NVMe	Tri-Mode	3.5" SAS	2.5" SAS	2.5" NVMe	3.5" SAS	2.5" SAS	2.5" NVMe	2.5" Any	
12	16	0	0	0	0	0	0	0	0	0	0	<ul style="list-style-type: none"> • 4XH7A60930, ThinkSystem V3 2U 8x2.5" SAS/SATA Backplane Option Kit • 4XH7A60930, ThinkSystem V3 2U 8x2.5" SAS/SATA Backplane Option Kit • 4X97A82933, ThinkSystem SR650 V3 2.5" Chassis Front BP1 SAS/SATA Cable Kit • 4X97A82935, ThinkSystem SR650 V3 2.5" Chassis Front BP2 SAS/SATA Cable Kit
29A/B	0	16	0	0	0	0	0	0	0	0	0	<ul style="list-style-type: none"> • 4XH7A82913, ThinkSystem SR650 V3 8x2.5" AnyBay Backplane Option Kit • 4XH7A82913, ThinkSystem SR650 V3 8x2.5" AnyBay Backplane Option Kit • 4X97A82933, ThinkSystem SR650 V3 2.5" Chassis Front BP1 SAS/SATA Cable Kit • 4X97A82932, ThinkSystem SR650 V3 2.5" Chassis Front BP1 NVMe Cable Kit • 4X97A82935, ThinkSystem SR650 V3 2.5" Chassis Front BP2 SAS/SATA Cable Kit • 4X97A82934, ThinkSystem SR650 V3 2.5" Chassis Front BP2 NVMe Cable Kit
14A	0	0	16	0	0	0	0	0	0	0	0	<ul style="list-style-type: none"> • 4XH7A61076, ThinkSystem V2/V3 2U 8x2.5" NVMe Backplane Option Kit • 4XH7A61076, ThinkSystem V2/V3 2U 8x2.5" NVMe Backplane Option Kit • 4X97A82932, ThinkSystem SR650 V3 2.5" Chassis Front BP1 NVMe Cable Kit • 4X97A82934, ThinkSystem SR650 V3 2.5" Chassis Front BP2 NVMe Cable Kit
14B	0	0	0	16	0	0	0	0	0	0	0	<ul style="list-style-type: none"> • 4XH7A82913, ThinkSystem SR650 V3 8x2.5" AnyBay Backplane Option Kit • 4XH7A82913, ThinkSystem SR650 V3 8x2.5" AnyBay Backplane Option Kit • 4X97A82933, ThinkSystem SR650 V3 2.5" Chassis Front BP1 SAS/SATA Cable Kit • 4X97A82935, ThinkSystem SR650 V3 2.5" Chassis Front BP2 SAS/SATA Cable Kit
13	0	8	8	0	0	0	0	0	0	0	0	<ul style="list-style-type: none"> • 4XH7A82913, ThinkSystem SR650 V3 8x2.5" AnyBay Backplane Option Kit • 4XH7A61076, ThinkSystem V2/V3 2U 8x2.5" NVMe Backplane Option Kit • 4X97A82933, ThinkSystem SR650 V3 2.5" Chassis Front BP1 SAS/SATA Cable Kit • 4X97A82932, ThinkSystem SR650 V3 2.5" Chassis Front BP1 NVMe Cable Kit • 4X97A82934, ThinkSystem SR650 V3 2.5" Chassis Front BP2 NVMe Cable Kit
15	8	8	0	0	0	0	0	0	0	0	0	<ul style="list-style-type: none"> • 4XH7A60930, ThinkSystem V3 2U 8x2.5" SAS/SATA Backplane Option Kit • 4XH7A82913, ThinkSystem SR650 V3 8x2.5" AnyBay Backplane Option Kit • 4X97A82933, ThinkSystem SR650 V3 2.5" Chassis Front BP1 SAS/SATA Cable Kit • 4X97A82935, ThinkSystem SR650 V3 2.5" Chassis Front BP2 SAS/SATA Cable Kit • 4X97A82934, ThinkSystem SR650 V3 2.5" Chassis Front BP2 NVMe Cable Kit

Config	2.5" front bays				Mid bays			Rear bays				Backplane and cable kits required (all required)
	SAS/SATA	Any Bay	NVMe	Tri-Mode	3.5" SAS	2.5" SAS	2.5" NVMe	3.5" SAS	2.5" SAS	2.5" NVMe	2.5" Any	
16	8	0	8	0	0	0	0	0	0	0	0	<ul style="list-style-type: none"> • 4XH7A60930, ThinkSystem V3 2U 8x2.5" SAS/SATA Backplane Option Kit • 4XH7A61076, ThinkSystem V2/V3 2U 8x2.5" NVMe Backplane Option Kit • 4X97A82933, ThinkSystem SR650 V3 2.5" Chassis Front BP1 SAS/SATA Cable Kit • 4X97A82934, ThinkSystem SR650 V3 2.5" Chassis Front BP2 NVMe Cable Kit
19-1/2	8	0	16	0	0	0	0	0	0	0	0	<ul style="list-style-type: none"> • 4XH7A60930, ThinkSystem V3 2U 8x2.5" SAS/SATA Backplane Option Kit • 4XH7A61076, ThinkSystem V2/V3 2U 8x2.5" NVMe Backplane Option Kit • 4XH7A61076, ThinkSystem V2/V3 2U 8x2.5" NVMe Backplane Option Kit • 4X97A82933, ThinkSystem SR650 V3 2.5" Chassis Front BP1 SAS/SATA Cable Kit • 4X97A82934, ThinkSystem SR650 V3 2.5" Chassis Front BP2 NVMe Cable Kit • 4X97A82936, ThinkSystem SR650 V3 2.5" Chassis Front BP3 NVMe Cable Kit
19-3	8	0	0	16	0	0	0	0	0	0	0	<ul style="list-style-type: none"> • 4XH7A60930, ThinkSystem V3 2U 8x2.5" SAS/SATA Backplane Option Kit • 4XH7A82913, ThinkSystem SR650 V3 8x2.5" AnyBay Backplane Option Kit • 4XH7A82913, ThinkSystem SR650 V3 8x2.5" AnyBay Backplane Option Kit • 4X97A82933, ThinkSystem SR650 V3 2.5" Chassis Front BP1 SAS/SATA Cable Kit • 4X97A82935, ThinkSystem SR650 V3 2.5" Chassis Front BP2 SAS/SATA Cable Kit • 4X97A82937, ThinkSystem SR650 V3 2.5" Chassis Front BP3 SAS/SATA Cable Kit
18	16	0	8	0	0	0	0	0	0	0	0	<ul style="list-style-type: none"> • 4XH7A60930, ThinkSystem V3 2U 8x2.5" SAS/SATA Backplane Option Kit • 4XH7A60930, ThinkSystem V3 2U 8x2.5" SAS/SATA Backplane Option Kit • 4XH7A61076, ThinkSystem V2/V3 2U 8x2.5" NVMe Backplane Option Kit • 4X97A82933, ThinkSystem SR650 V3 2.5" Chassis Front BP1 SAS/SATA Cable Kit • 4X97A82935, ThinkSystem SR650 V3 2.5" Chassis Front BP2 SAS/SATA Cable Kit • 4X97A82936, ThinkSystem SR650 V3 2.5" Chassis Front BP3 NVMe Cable Kit
17	16	8	0	0	0	0	0	0	0	0	0	<ul style="list-style-type: none"> • 4XH7A60930, ThinkSystem V3 2U 8x2.5" SAS/SATA Backplane Option Kit • 4XH7A60930, ThinkSystem V3 2U 8x2.5" SAS/SATA Backplane Option Kit • 4XH7A82913, ThinkSystem SR650 V3 8x2.5" AnyBay Backplane Option Kit • 4X97A82933, ThinkSystem SR650 V3 2.5" Chassis Front BP1 SAS/SATA Cable Kit • 4X97A82935, ThinkSystem SR650 V3 2.5" Chassis Front BP2 SAS/SATA Cable Kit • 4X97A82937, ThinkSystem SR650 V3 2.5" Chassis Front BP3 SAS/SATA Cable Kit • 4X97A82936, ThinkSystem SR650 V3 2.5" Chassis Front BP3 NVMe Cable Kit

Config	2.5" front bays				Mid bays			Rear bays				Backplane and cable kits required (all required)
	SAS/SATA	Any Bay	NVMe	Tri-Mode	3.5" SAS	2.5" SAS	2.5" NVMe	3.5" SAS	2.5" SAS	2.5" NVMe	2.5" Any	
22	16	8	0	0	0	0	0	0	4	0	0	<ul style="list-style-type: none"> • 4XH7A60930, ThinkSystem V3 2U 8x2.5" SAS/SATA Backplane Option Kit • 4XH7A60930, ThinkSystem V3 2U 8x2.5" SAS/SATA Backplane Option Kit • 4XH7A60934, ThinkSystem SR665 8x2.5" AnyBay Backplane Option Kit • 4XH7A60938, ThinkSystem V3 2U 4x2.5" SAS/SATA Rear Backplane Option Kit • 4X97A82933, ThinkSystem SR650 V3 2.5" Chassis Front BP1 SAS/SATA Cable Kit • 4X97A82935, ThinkSystem SR650 V3 2.5" Chassis Front BP2 SAS/SATA Cable Kit • 4X97A82937, ThinkSystem SR650 V3 2.5" Chassis Front BP3 SAS/SATA Cable Kit • 4X97A82936, ThinkSystem SR650 V3 2.5" Chassis Front BP3 NVMe Cable Kit • 4X97A82938, ThinkSystem SR650 V3 2.5" Chassis Rear Backplane SAS/SATA Cable Kit
20	24	0	0	0	0	0	0	0	0	0	0	<ul style="list-style-type: none"> • 4XH7A60930, ThinkSystem V3 2U 8x2.5" SAS/SATA Backplane Option Kit • 4XH7A60930, ThinkSystem V3 2U 8x2.5" SAS/SATA Backplane Option Kit • 4XH7A60930, ThinkSystem V3 2U 8x2.5" SAS/SATA Backplane Option Kit • 4X97A82933, ThinkSystem SR650 V3 2.5" Chassis Front BP1 SAS/SATA Cable Kit • 4X97A82935, ThinkSystem SR650 V3 2.5" Chassis Front BP2 SAS/SATA Cable Kit • 4X97A82937, ThinkSystem SR650 V3 2.5" Chassis Front BP3 SAS/SATA Cable Kit
21A	0	8	16	0	0	0	0	0	0	0	0	<ul style="list-style-type: none"> • 4XH7A82913, ThinkSystem SR650 V3 8x2.5" AnyBay Backplane Option Kit • 4XH7A61076, ThinkSystem V2/V3 2U 8x2.5" NVMe Backplane Option Kit • 4XH7A61076, ThinkSystem V2/V3 2U 8x2.5" NVMe Backplane Option Kit • 4X97A82933, ThinkSystem SR650 V3 2.5" Chassis Front BP1 SAS/SATA Cable Kit • 4X97A82932, ThinkSystem SR650 V3 2.5" Chassis Front BP1 NVMe Cable Kit • 4X97A82934, ThinkSystem SR650 V3 2.5" Chassis Front BP2 NVMe Cable Kit • 4X97A82936, ThinkSystem SR650 V3 2.5" Chassis Front BP3 NVMe Cable Kit
21-2/3	0	0	0	24	0	0	0	0	0	0	0	<ul style="list-style-type: none"> • 4XH7A82913, ThinkSystem SR650 V3 8x2.5" AnyBay Backplane Option Kit • 4XH7A82913, ThinkSystem SR650 V3 8x2.5" AnyBay Backplane Option Kit • 4XH7A82913, ThinkSystem SR650 V3 8x2.5" AnyBay Backplane Option Kit • 4X97A82933, ThinkSystem SR650 V3 2.5" Chassis Front BP1 SAS/SATA Cable Kit • 4X97A82935, ThinkSystem SR650 V3 2.5" Chassis Front BP2 SAS/SATA Cable Kit • 4X97A82937, ThinkSystem SR650 V3 2.5" Chassis Front BP3 SAS/SATA Cable Kit

Config	2.5" front bays				Mid bays			Rear bays				Backplane and cable kits required (all required)
	SAS/SATA	Any Bay	NVMe	Tri-Mode	3.5" SAS	2.5" SAS	2.5" NVMe	3.5" SAS	2.5" SAS	2.5" NVMe	2.5" Any	
23	24	0	0	0	0	0	0	0	4	0	0	<ul style="list-style-type: none"> • 4XH7A60930, ThinkSystem V3 2U 8x2.5" SAS/SATA Backplane Option Kit • 4XH7A60930, ThinkSystem V3 2U 8x2.5" SAS/SATA Backplane Option Kit • 4XH7A60930, ThinkSystem V3 2U 8x2.5" SAS/SATA Backplane Option Kit • 4XH7A60938, ThinkSystem V3 2U 4x2.5" SAS/SATA Rear Backplane Option Kit • 4X97A82933, ThinkSystem SR650 V3 2.5" Chassis Front BP1 SAS/SATA Cable Kit • 4X97A82935, ThinkSystem SR650 V3 2.5" Chassis Front BP2 SAS/SATA Cable Kit • 4X97A82937, ThinkSystem SR650 V3 2.5" Chassis Front BP3 SAS/SATA Cable Kit • 4X97A82938, ThinkSystem SR650 V3 2.5" Chassis Rear Backplane SAS/SATA Cable Kit
23A	24	0	0	0	0	0	0	0	8	0	0	<ul style="list-style-type: none"> • 4XH7A60930, ThinkSystem V3 2U 8x2.5" SAS/SATA Backplane Option Kit • 4XH7A60930, ThinkSystem V3 2U 8x2.5" SAS/SATA Backplane Option Kit • 4XH7A60930, ThinkSystem V3 2U 8x2.5" SAS/SATA Backplane Option Kit • 4XH7A60941, ThinkSystem SR650 V2/SR665 Rear 8x2.5" SAS/SATA Backplane Option Kit • 4X97A82933, ThinkSystem SR650 V3 2.5" Chassis Front BP1 SAS/SATA Cable Kit • 4X97A82935, ThinkSystem SR650 V3 2.5" Chassis Front BP2 SAS/SATA Cable Kit • 4X97A82937, ThinkSystem SR650 V3 2.5" Chassis Front BP3 SAS/SATA Cable Kit • 4X97A82938, ThinkSystem SR650 V3 2.5" Chassis Rear Backplane SAS/SATA Cable Kit
25	24	0	0	0	0	8	0	0	8	0	0	<ul style="list-style-type: none"> • 4XH7A60930, ThinkSystem V3 2U 8x2.5" SAS/SATA Backplane Option Kit • 4XH7A60930, ThinkSystem V3 2U 8x2.5" SAS/SATA Backplane Option Kit • 4XH7A60930, ThinkSystem V3 2U 8x2.5" SAS/SATA Backplane Option Kit • 4XH7A82914, ThinkSystem SR650 V3 Middle 8x2.5" SAS/SATA Backplane Option Kit • 4XH7A60941, ThinkSystem SR650 V2/SR665 Rear 8x2.5" SAS/SATA Backplane Option Kit • 4X97A82933, ThinkSystem SR650 V3 2.5" Chassis Front BP1 SAS/SATA Cable Kit • 4X97A82935, ThinkSystem SR650 V3 2.5" Chassis Front BP2 SAS/SATA Cable Kit • 4X97A82937, ThinkSystem SR650 V3 2.5" Chassis Front BP3 SAS/SATA Cable Kit • 4X97A82939, ThinkSystem SR650 V3 2.5" Chassis Middle Backplane SAS/SATA Cable Kit • 4X97A82938, ThinkSystem SR650 V3 2.5" Chassis Rear Backplane SAS/SATA Cable Kit

Config	2.5" front bays				Mid bays			Rear bays				Backplane and cable kits required (all required)
	SAS/SATA	Any Bay	NVMe	Tri-Mode	3.5" SAS	2.5" SAS	2.5" NVMe	3.5" SAS	2.5" SAS	2.5" NVMe	2.5" Any	
21-1	0	0	24	0	0	0	0	0	0	0	0	<ul style="list-style-type: none"> • 4XH7A61076, ThinkSystem V2/V3 2U 8x2.5" NVMe Backplane Option Kit • 4XH7A61076, ThinkSystem V2/V3 2U 8x2.5" NVMe Backplane Option Kit • 4XH7A61076, ThinkSystem V2/V3 2U 8x2.5" NVMe Backplane Option Kit • 4X97A82942, ThinkSystem SR650 V3 24x2.5" NVMe Cable Kit
24	0	0	24	0	0	0	8	0	0	0	0	<ul style="list-style-type: none"> • 4XH7A61076, ThinkSystem V2/V3 2U 8x2.5" NVMe Backplane Option Kit • 4XH7A61076, ThinkSystem V2/V3 2U 8x2.5" NVMe Backplane Option Kit • 4XH7A61076, ThinkSystem V2/V3 2U 8x2.5" NVMe Backplane Option Kit • 4XH7A82915, ThinkSystem SR650 V3 Middle 8x2.5" NVMe Backplane Option Kit • 4X97A82943, ThinkSystem SR650 V3 32x2.5" NVMe Cable Kit
'25C	24	0	0	0	0	8	0	0	4	0	0	<ul style="list-style-type: none"> • 4XH7A60930, ThinkSystem V3 2U 8x2.5" SAS/SATA Backplane Option Kit • 4XH7A60930, ThinkSystem V3 2U 8x2.5" SAS/SATA Backplane Option Kit • 4XH7A60930, ThinkSystem V3 2U 8x2.5" SAS/SATA Backplane Option Kit • 4XH7A82914, ThinkSystem SR650 V3 Middle 8x2.5" SAS/SATA Backplane Option Kit • 4XH7A60938, ThinkSystem V3 2U 4x2.5" SAS/SATA Rear Backplane Option Kit • 4X97A82933, ThinkSystem SR650 V3 2.5" Chassis Front BP1 SAS/SATA Cable Kit • 4X97A82935, ThinkSystem SR650 V3 2.5" Chassis Front BP2 SAS/SATA Cable Kit • 4X97A82937, ThinkSystem SR650 V3 2.5" Chassis Front BP3 SAS/SATA Cable Kit • 4X97A82939, ThinkSystem SR650 V3 2.5" Chassis Middle Backplane SAS/SATA Cable Kit • 4X97A82938, ThinkSystem SR650 V3 2.5" Chassis Rear Backplane SAS/SATA Cable Kit
25A	24	0	0	0	0	4	0	0	0	0	0	<ul style="list-style-type: none"> • 4XH7A60930, ThinkSystem V3 2U 8x2.5" SAS/SATA Backplane Option Kit • 4XH7A60930, ThinkSystem V3 2U 8x2.5" SAS/SATA Backplane Option Kit • 4XH7A60930, ThinkSystem V3 2U 8x2.5" SAS/SATA Backplane Option Kit • 4XH7A87509, ThinkSystem SR650 V3 Middle 4x2.5" SAS/SATA Backplane Option Kit • 4X97A82933, ThinkSystem SR650 V3 2.5" Chassis Front BP1 SAS/SATA Cable Kit • 4X97A82935, ThinkSystem SR650 V3 2.5" Chassis Front BP2 SAS/SATA Cable Kit • 4X97A82937, ThinkSystem SR650 V3 2.5" Chassis Front BP3 SAS/SATA Cable Kit • 4X97A82939, ThinkSystem SR650 V3 2.5" Chassis Middle Backplane SAS/SATA Cable Kit

Config	2.5" front bays				Mid bays			Rear bays				Backplane and cable kits required (all required)
	SAS/SATA	Any Bay	NVMe	Tri-Mode	3.5" SAS	2.5" SAS	2.5" NVMe	3.5" SAS	2.5" SAS	2.5" NVMe	2.5" Any	
25B	24	0	0	0	0	8	0	0	0	0	0	<ul style="list-style-type: none"> • 4XH7A60930, ThinkSystem V3 2U 8x2.5" SAS/SATA Backplane Option Kit • 4XH7A60930, ThinkSystem V3 2U 8x2.5" SAS/SATA Backplane Option Kit • 4XH7A60930, ThinkSystem V3 2U 8x2.5" SAS/SATA Backplane Option Kit • 4XH7A82914, ThinkSystem SR650 V3 Middle 8x2.5" SAS/SATA Backplane Option Kit • 4X97A82933, ThinkSystem SR650 V3 2.5" Chassis Front BP1 SAS/SATA Cable Kit • 4X97A82935, ThinkSystem SR650 V3 2.5" Chassis Front BP2 SAS/SATA Cable Kit • 4X97A82937, ThinkSystem SR650 V3 2.5" Chassis Front BP3 SAS/SATA Cable Kit • 4X97A82939, ThinkSystem SR650 V3 2.5" Chassis Middle Backplane SAS/SATA Cable Kit
47	24-EXP	0	0	0	0	0	0	0	0	0	0	<ul style="list-style-type: none"> • 4XH7A86134, ThinkSystem SR665 V3/SR655 V3 24x2.5" Expander Backplane Option Kit • 4X97A87505, ThinkSystem SR650 V3 3.5"/2.5" Chassis Front Expander Backplane SAS/SATA Cable Kit
48	24-EXP	0	0	0	0	0	0	0	4	0	0	<ul style="list-style-type: none"> • 4XH7A86134, ThinkSystem SR665 V3/SR655 V3 24x2.5" Expander Backplane Option Kit • 4XH7A60938, ThinkSystem V3 2U 4x2.5" SAS/SATA Rear Backplane Option Kit • 4X97A87505, ThinkSystem SR650 V3 3.5"/2.5" Chassis Front Expander Backplane SAS/SATA Cable Kit • 4X97A82938, ThinkSystem SR650 V3 2.5" Chassis Rear Backplane SAS/SATA Cable Kit
49	24-EXP	0	0	0	0	0	0	0	0	0	4	<ul style="list-style-type: none"> • 4XH7A86134, ThinkSystem SR665 V3/SR655 V3 24x2.5" Expander Backplane Option Kit • 4XH7A87545, ThinkSystem 2U V3 Rear 4x2.5" Gen5 NVMe Backplane Option Kit • 4X97A87505, ThinkSystem SR650 V3 3.5"/2.5" Chassis Front Expander Backplane SAS/SATA Cable Kit • 4X97A82938, ThinkSystem SR650 V3 2.5" Chassis Rear Backplane SAS/SATA Cable Kit • 4X97A87062, ThinkSystem SR650 V3 2.5" Chassis Rear Backplane NVMe Cable Kit
50	24-EXP	0	0	0	0	0	0	0	8	0	0	<ul style="list-style-type: none"> • 4XH7A86134, ThinkSystem SR665 V3/SR655 V3 24x2.5" Expander Backplane Option Kit • 4XH7A60941, ThinkSystem SR650 V2/SR665 Rear 8x2.5" SAS/SATA Backplane Option Kit • 4X97A87505, ThinkSystem SR650 V3 3.5"/2.5" Chassis Front Expander Backplane SAS/SATA Cable Kit • 4X97A82938, ThinkSystem SR650 V3 2.5" Chassis Rear Backplane SAS/SATA Cable Kit

Config	2.5" front bays				Mid bays			Rear bays				Backplane and cable kits required (all required)
	SAS/SATA	Any Bay	NVMe	Tri-Mode	3.5" SAS	2.5" SAS	2.5" NVMe	3.5" SAS	2.5" SAS	2.5" NVMe	2.5" Any	
51	0	0	24	0	0	0	0	0	0	4	0	<ul style="list-style-type: none"> • 4XH7A61076, ThinkSystem V2/V3 2U 8x2.5" NVMe Backplane Option Kit • 4XH7A61076, ThinkSystem V2/V3 2U 8x2.5" NVMe Backplane Option Kit • 4XH7A61076, ThinkSystem V2/V3 2U 8x2.5" NVMe Backplane Option Kit • 4XH7A86661, ThinkSystem 1U 4x2.5" AnyBay Backplane • 4X97A82942, ThinkSystem SR650 V3 24x2.5" NVMe Cable Kit • 4X97A90339, ThinkSystem SR650 V3 2.5" Chassis Middle Backplane Gen5 NVMe Cable Kit
52	0	0	24	0	0	0	8	0	0	4	0	<ul style="list-style-type: none"> • 4XH7A61076, ThinkSystem V2/V3 2U 8x2.5" NVMe Backplane Option Kit • 4XH7A61076, ThinkSystem V2/V3 2U 8x2.5" NVMe Backplane Option Kit • 4XH7A61076, ThinkSystem V2/V3 2U 8x2.5" NVMe Backplane Option Kit • 4XH7A82915, ThinkSystem SR650 V3 Middle 8x2.5" NVMe Backplane Option Kit • 4XH7A87545, ThinkSystem 2U V3 Rear 4x2.5" Gen5 NVMe Backplane Option Kit • 4X97A90336, ThinkSystem SR650 V3 36x2.5" Gen4 NVMe Cable Kit

Drive bay field upgrades - 2.5-inch chassis with Gen5 front bays

The tables below lists the backplane kits and cable kits needed to build one of the supported 2.5-inch chassis configurations with Gen5 NVMe or AnyBay front backplanes.

The Config numbers listed here match the configuration listed in the Storage configuration [Overview](#) and [Details](#) sections.

Return to [Field upgrades](#).

Table 38. Drive bay field upgrades for the 2.5-inch chassis (Gen5 NVMe/AnyBay) (Blue = SAS/SATA, Purple = AnyBay, Red = NVMe)

Config	2.5" front bays				Mid bays			Rear bays				Backplane and cable kits required (all required)
	SAS/SATA	Any Bay	NVMe	Tri-Mode	3.5" SAS	2.5" SAS	2.5" NVMe	3.5" SAS	2.5" SAS	2.5" NVMe	2.5" Any	
60, 82A/B	0	8	0	0	0	0	0	0	0	0	0	<ul style="list-style-type: none"> • 4XH7A86660, ThinkSystem V3 2U 8x2.5" AnyBay Backplane Gen5 Option Kit • 4X97A82933, ThinkSystem SR650 V3 2.5" Chassis Front BP1 SAS/SATA Cable Kit • 4X97A88458, ThinkSystem SR650 V3 2.5" Chassis Front BP1 Gen5 NVMe Cable Kit
61, 83A/B	0	0	8	0	0	0	0	0	0	0	0	<ul style="list-style-type: none"> • 4XH7A87748, ThinkSystem V3 2U 8x2.5" NVMe Backplane Gen5 Option Kit • 4X97A88458, ThinkSystem SR650 V3 2.5" Chassis Front BP1 Gen5 NVMe Cable Kit

Config	2.5" front bays				Mid bays			Rear bays				Backplane and cable kits required (all required)
	SAS/SATA	Any Bay	NVMe	Tri-Mode	3.5" SAS	2.5" SAS	2.5" NVMe	3.5" SAS	2.5" SAS	2.5" NVMe	2.5" Any	
75A/B, 93A/B/C/D	0	16	0	0	0	0	0	0	0	0	0	<ul style="list-style-type: none"> • 4XH7A86660, ThinkSystem V3 2U 8x2.5" AnyBay Backplane Gen5 Option Kit • 4XH7A86660, ThinkSystem V3 2U 8x2.5" AnyBay Backplane Gen5 Option Kit • 4X97A82933, ThinkSystem SR650 V3 2.5" Chassis Front BP1 SAS/SATA Cable Kit • 4X97A88458, ThinkSystem SR650 V3 2.5" Chassis Front BP1 Gen5 NVMe Cable Kit • 4X97A82935, ThinkSystem SR650 V3 2.5" Chassis Front BP2 SAS/SATA Cable Kit • 4X97A88459, ThinkSystem SR650 V3 2.5" Chassis Front BP2 Gen5 NVMe Cable Kit
63, 89A/B/C	0	0	16	0	0	0	0	0	0	0	0	<ul style="list-style-type: none"> • 4XH7A87748, ThinkSystem V3 2U 8x2.5" NVMe Backplane Gen5 Option Kit • 4XH7A87748, ThinkSystem V3 2U 8x2.5" NVMe Backplane Gen5 Option Kit • 4X97A88458, ThinkSystem SR650 V3 2.5" Chassis Front BP1 Gen5 NVMe Cable Kit • 4X97A88459, ThinkSystem SR650 V3 2.5" Chassis Front BP2 Gen5 NVMe Cable Kit
62, 90A/B/C	0	8	8	0	0	0	0	0	0	0	0	<ul style="list-style-type: none"> • 4XH7A86660, ThinkSystem V3 2U 8x2.5" AnyBay Backplane Gen5 Option Kit • 4XH7A87748, ThinkSystem V3 2U 8x2.5" NVMe Backplane Gen5 Option Kit • 4X97A82933, ThinkSystem SR650 V3 2.5" Chassis Front BP1 SAS/SATA Cable Kit • 4X97A88458, ThinkSystem SR650 V3 2.5" Chassis Front BP1 Gen5 NVMe Cable Kit • 4X97A88459, ThinkSystem SR650 V3 2.5" Chassis Front BP2 Gen5 NVMe Cable Kit
64, 84A/B	8	8	0	0	0	0	0	0	0	0	0	<ul style="list-style-type: none"> • 4XH7A60930, ThinkSystem V3 2U 8x2.5" SAS/SATA Backplane Option Kit • 4XH7A86660, ThinkSystem V3 2U 8x2.5" AnyBay Backplane Gen5 Option Kit • 4X97A82933, ThinkSystem SR650 V3 2.5" Chassis Front BP1 SAS/SATA Cable Kit • 4X97A82935, ThinkSystem SR650 V3 2.5" Chassis Front BP2 SAS/SATA Cable Kit • 4X97A88459, ThinkSystem SR650 V3 2.5" Chassis Front BP2 Gen5 NVMe Cable Kit

Config	2.5" front bays				Mid bays			Rear bays				Backplane and cable kits required (all required)
	SAS/SATA	Any Bay	NVMe	Tri-Mode	3.5" SAS	2.5" SAS	2.5" NVMe	3.5" SAS	2.5" SAS	2.5" NVMe	2.5" Any	
65, 85A/B	8	0	8	0	0	0	0	0	0	0	0	<ul style="list-style-type: none"> • 4XH7A60930, ThinkSystem V3 2U 8x2.5" SAS/SATA Backplane Option Kit • 4XH7A87748, ThinkSystem V3 2U 8x2.5" NVMe Backplane Gen5 Option Kit • 4X97A82933, ThinkSystem SR650 V3 2.5" Chassis Front BP1 SAS/SATA Cable Kit • 4X97A88459, ThinkSystem SR650 V3 2.5" Chassis Front BP2 Gen5 NVMe Cable Kit
69, 91A/B	8	0	16	0	0	0	0	0	0	0	0	<ul style="list-style-type: none"> • 4XH7A60930, ThinkSystem V3 2U 8x2.5" SAS/SATA Backplane Option Kit • 4XH7A87748, ThinkSystem V3 2U 8x2.5" NVMe Backplane Gen5 Option Kit • 4XH7A87748, ThinkSystem V3 2U 8x2.5" NVMe Backplane Gen5 Option Kit • 4X97A82933, ThinkSystem SR650 V3 2.5" Chassis Front BP1 SAS/SATA Cable Kit • 4X97A88459, ThinkSystem SR650 V3 2.5" Chassis Front BP2 Gen5 NVMe Cable Kit • 4X97A88460, ThinkSystem SR650 V3 2.5" Chassis Front BP3 Gen5 NVMe Cable Kit
68, 87A/B	16	0	8	0	0	0	0	0	0	0	0	<ul style="list-style-type: none"> • 4XH7A60930, ThinkSystem V3 2U 8x2.5" SAS/SATA Backplane Option Kit • 4XH7A60930, ThinkSystem V3 2U 8x2.5" SAS/SATA Backplane Option Kit • 4XH7A87748, ThinkSystem V3 2U 8x2.5" NVMe Backplane Gen5 Option Kit • 4X97A82933, ThinkSystem SR650 V3 2.5" Chassis Front BP1 SAS/SATA Cable Kit • 4X97A82935, ThinkSystem SR650 V3 2.5" Chassis Front BP2 SAS/SATA Cable Kit • 4X97A88460, ThinkSystem SR650 V3 2.5" Chassis Front BP3 Gen5 NVMe Cable Kit

Config	2.5" front bays				Mid bays			Rear bays				Backplane and cable kits required (all required)
	SAS/SATA	Any Bay	NVMe	Tri-Mode	3.5" SAS	2.5" SAS	2.5" NVMe	3.5" SAS	2.5" SAS	2.5" NVMe	2.5" Any	
67, 86A/B	16	8	0	0	0	0	0	0	0	0	0	<ul style="list-style-type: none"> • 4XH7A60930, ThinkSystem V3 2U 8x2.5" SAS/SATA Backplane Option Kit • 4XH7A60930, ThinkSystem V3 2U 8x2.5" SAS/SATA Backplane Option Kit • 4XH7A86660, ThinkSystem V3 2U 8x2.5" AnyBay Backplane Gen5 Option Kit • 4X97A82933, ThinkSystem SR650 V3 2.5" Chassis Front BP1 SAS/SATA Cable Kit • 4X97A82935, ThinkSystem SR650 V3 2.5" Chassis Front BP2 SAS/SATA Cable Kit • 4X97A82937, ThinkSystem SR650 V3 2.5" Chassis Front BP3 SAS/SATA Cable Kit • 4X97A88460, ThinkSystem SR650 V3 2.5" Chassis Front BP3 Gen5 NVMe Cable Kit
72, 96	16	8	0	0	0	0	0	0	4	0	0	<ul style="list-style-type: none"> • 4XH7A60930, ThinkSystem V3 2U 8x2.5" SAS/SATA Backplane Option Kit • 4XH7A60930, ThinkSystem V3 2U 8x2.5" SAS/SATA Backplane Option Kit • 4XH7A86660, ThinkSystem V3 2U 8x2.5" AnyBay Backplane Gen5 Option Kit • 4XH7A60938, ThinkSystem V3 2U 4x2.5" SAS/SATA Rear Backplane Option Kit • 4X97A82933, ThinkSystem SR650 V3 2.5" Chassis Front BP1 SAS/SATA Cable Kit • 4X97A82935, ThinkSystem SR650 V3 2.5" Chassis Front BP2 SAS/SATA Cable Kit • 4X97A82937, ThinkSystem SR650 V3 2.5" Chassis Front BP3 SAS/SATA Cable Kit • 4X97A88460, ThinkSystem SR650 V3 2.5" Chassis Front BP3 Gen5 NVMe Cable Kit • 4X97A82938, ThinkSystem SR650 V3 2.5" Chassis Rear Backplane SAS/SATA Cable Kit

Config	2.5" front bays				Mid bays			Rear bays				Backplane and cable kits required (all required)
	SAS/SATA	Any Bay	NVMe	Tri-Mode	3.5" SAS	2.5" SAS	2.5" NVMe	3.5" SAS	2.5" SAS	2.5" NVMe	2.5" Any	
71, 95A/B	0	8	16	0	0	0	0	0	0	0	0	<ul style="list-style-type: none"> • 4XH7A86660, ThinkSystem V3 2U 8x2.5" AnyBay Backplane Gen5 Option Kit • 4XH7A87748, ThinkSystem V3 2U 8x2.5" NVMe Backplane Gen5 Option Kit • 4XH7A87748, ThinkSystem V3 2U 8x2.5" NVMe Backplane Gen5 Option Kit • 4X97A82933, ThinkSystem SR650 V3 2.5" Chassis Front BP1 SAS/SATA Cable Kit • 4X97A88458, ThinkSystem SR650 V3 2.5" Chassis Front BP1 Gen5 NVMe Cable Kit • 4X97A88459, ThinkSystem SR650 V3 2.5" Chassis Front BP2 Gen5 NVMe Cable Kit • 4X97A88460, ThinkSystem SR650 V3 2.5" Chassis Front BP3 Gen5 NVMe Cable Kit
70, 94A/B	0	0	24	0	0	0	0	0	0	0	0	<ul style="list-style-type: none"> • 4XH7A86660, ThinkSystem V3 2U 8x2.5" AnyBay Backplane Gen5 Option Kit • 4XH7A86660, ThinkSystem V3 2U 8x2.5" AnyBay Backplane Gen5 Option Kit • 4XH7A86660, ThinkSystem V3 2U 8x2.5" AnyBay Backplane Gen5 Option Kit • 4X97A88461, ThinkSystem SR650 V3 24x2.5" Gen5 NVMe Cable Kit
92	4	12	0	0	0	0	0	0	0	0	0	<ul style="list-style-type: none"> • 4XH7A86660, ThinkSystem V3 2U 8x2.5" AnyBay Backplane Gen5 Option Kit • 4XH7A86660, ThinkSystem V3 2U 8x2.5" AnyBay Backplane Gen5 Option Kit • 4X97A82933, ThinkSystem SR650 V3 2.5" Chassis Front BP1 SAS/SATA Cable Kit • 4X97A88458, ThinkSystem SR650 V3 2.5" Chassis Front BP1 Gen5 NVMe Cable Kit • 4X97A82935, ThinkSystem SR650 V3 2.5" Chassis Front BP2 SAS/SATA Cable Kit • 4X97A88459, ThinkSystem SR650 V3 2.5" Chassis Front BP2 Gen5 NVMe Cable Kit

Config	2.5" front bays				Mid bays			Rear bays				Backplane and cable kits required (all required)
	SAS/SATA	Any Bay	NVMe	Tri-Mode	3.5" SAS	2.5" SAS	2.5" NVMe	3.5" SAS	2.5" SAS	2.5" NVMe	2.5" Any	
98	0	0	24	0	0	0	0	0	0	0	4	<ul style="list-style-type: none"> • 4XH7A87748, ThinkSystem V3 2U 8x2.5" NVMe Backplane Gen5 Option Kit • 4XH7A87748, ThinkSystem V3 2U 8x2.5" NVMe Backplane Gen5 Option Kit • 4XH7A87748, ThinkSystem V3 2U 8x2.5" NVMe Backplane Gen5 Option Kit • 4XH7A87545, ThinkSystem 2U V3 Rear 4x2.5" Gen5 NVMe Backplane Option Kit • 4X97A88461, ThinkSystem SR650 V3 24x2.5" Gen5 NVMe Cable Kit • 4X97A87062, ThinkSystem SR650 V3 2.5" Chassis Rear Backplane NVMe Cable Kit
103	0	0	24	0	0	0	8	0	0	0	0	<ul style="list-style-type: none"> • 4XH7A87748, ThinkSystem V3 2U 8x2.5" NVMe Backplane Gen5 Option Kit • 4XH7A87748, ThinkSystem V3 2U 8x2.5" NVMe Backplane Gen5 Option Kit • 4XH7A87748, ThinkSystem V3 2U 8x2.5" NVMe Backplane Gen5 Option Kit • 4XH7A90334, ThinkSystem V3 2U Middle 8x2.5" Gen5 NVMe Backplane Option Kit • 4X97A90335, ThinkSystem SR650 V3 32x2.5" Gen5 NVMe Cable Kit
104	0	0	24	0	0	0	8	0	0	4	0	<ul style="list-style-type: none"> • 4XH7A87748, ThinkSystem V3 2U 8x2.5" NVMe Backplane Gen5 Option Kit • 4XH7A87748, ThinkSystem V3 2U 8x2.5" NVMe Backplane Gen5 Option Kit • 4XH7A87748, ThinkSystem V3 2U 8x2.5" NVMe Backplane Gen5 Option Kit • 4XH7A90334, ThinkSystem V3 2U Middle 8x2.5" Gen5 NVMe Backplane Option Kit • 4XH7A87545, ThinkSystem 2U V3 Rear 4x2.5" Gen5 NVMe Backplane Option Kit • 4X97A90337, ThinkSystem SR650 V3 36x2.5" Gen5 NVMe Cable Kit

Drive bay field upgrades - 2.5-inch chassis with front slots

The tables below lists the backplane kits and cable kits needed to build one of the supported 2.5-inch chassis configurations with front and rear.

The Config numbers listed here match the configuration listed in the Storage configuration [Overview](#) and [Details](#) sections.

Return to [Field upgrades](#).

Table 39. Drive bay field upgrades for the 2.5-inch chassis with front PCIe slots (Blue = SAS/SATA, Purple = AnyBay, Red = NVMe)

Config	2.5" front bays				Mid bays			Rear bays				Backplane and cable kits required (all required)
	SAS/SATA	Any Bay	NVMe	Tri-Mode	3.5" SAS	2.5" SAS	2.5" NVMe	3.5" SAS	2.5" SAS	2.5" NVMe	2.5" Any	
31	8	0	0	0	0	0	0	0	0	0	0	<ul style="list-style-type: none"> 4XH7A60930, ThinkSystem V3 2U 8x2.5" SAS/SATA Backplane Option Kit 4X97A82933, ThinkSystem SR650 V3 2.5" Chassis Front BP1 SAS/SATA Cable Kit
32	0	8	0	0	0	0	0	0	0	0	0	<ul style="list-style-type: none"> 4XH7A82913, ThinkSystem SR650 V3 8x2.5" AnyBay Backplane Option Kit 4X97A82933, ThinkSystem SR650 V3 2.5" Chassis Front BP1 SAS/SATA Cable Kit 4X97A82932, ThinkSystem SR650 V3 2.5" Chassis Front BP1 NVMe Cable Kit
34	0	0	8	0	0	0	0	0	0	0	0	<ul style="list-style-type: none"> 4XH7A61076, ThinkSystem V2/V3 2U 8x2.5" NVMe Backplane Option Kit 4X97A82932, ThinkSystem SR650 V3 2.5" Chassis Front BP1 NVMe Cable Kit
33	0	0	0	8	0	0	0	0	0	0	0	<ul style="list-style-type: none"> 4XH7A82913, ThinkSystem SR650 V3 8x2.5" AnyBay Backplane Option Kit 4X97A82933, ThinkSystem SR650 V3 2.5" Chassis Front BP1 SAS/SATA Cable Kit
40	14	0	0	0	0	0	0	0	0	0	0	<ul style="list-style-type: none"> 4XH7A60930, ThinkSystem V3 2U 8x2.5" SAS/SATA Backplane Option Kit 4XH7A60930, ThinkSystem V3 2U 8x2.5" SAS/SATA Backplane Option Kit 4X97A82933, ThinkSystem SR650 V3 2.5" Chassis Front BP1 SAS/SATA Cable Kit 4X97A90341, ThinkSystem SR650 V3 2.5" Chassis Front I/O BP2 Gen5 NVMe Cable Kit
35	16	0	0	0	0	0	0	0	0	0	0	<ul style="list-style-type: none"> 4XH7A60930, ThinkSystem V3 2U 8x2.5" SAS/SATA Backplane Option Kit 4XH7A60930, ThinkSystem V3 2U 8x2.5" SAS/SATA Backplane Option Kit 4X97A82933, ThinkSystem SR650 V3 2.5" Chassis Front BP1 SAS/SATA Cable Kit 4X97A90341, ThinkSystem SR650 V3 2.5" Chassis Front I/O BP2 Gen5 NVMe Cable Kit
38	0	0	16	0	0	0	0	0	0	0	0	<ul style="list-style-type: none"> 4XH7A61076, ThinkSystem V2/V3 2U 8x2.5" NVMe Backplane Option Kit 4XH7A61076, ThinkSystem V2/V3 2U 8x2.5" NVMe Backplane Option Kit 4X97A82932, ThinkSystem SR650 V3 2.5" Chassis Front BP1 NVMe Cable Kit 4X97A90342, ThinkSystem SR650 V3 2.5" Chassis Front I/O BP2 NVMe Cable Kit
39	0	0	0	16	0	0	0	0	0	0	0	<ul style="list-style-type: none"> 4XH7A82913, ThinkSystem SR650 V3 8x2.5" AnyBay Backplane Option Kit 4XH7A82913, ThinkSystem SR650 V3 8x2.5" AnyBay Backplane Option Kit 4X97A82933, ThinkSystem SR650 V3 2.5" Chassis Front BP1 SAS/SATA Cable Kit 4X97A90341, ThinkSystem SR650 V3 2.5" Chassis Front I/O BP2 Gen5 NVMe Cable Kit

Config	2.5" front bays				Mid bays			Rear bays				Backplane and cable kits required (all required)
	SAS/SATA	Any Bay	NVMe	Tri-Mode	3.5" SAS	2.5" SAS	2.5" NVMe	3.5" SAS	2.5" SAS	2.5" NVMe	2.5" Any	
36	8	8	0	0	0	0	0	0	0	0	0	<ul style="list-style-type: none"> • 4XH7A60930, ThinkSystem V3 2U 8x2.5" SAS/SATA Backplane Option Kit • 4XH7A82913, ThinkSystem SR650 V3 8x2.5" AnyBay Backplane Option Kit • 4X97A82933, ThinkSystem SR650 V3 2.5" Chassis Front BP1 SAS/SATA Cable Kit • 4X97A90341, ThinkSystem SR650 V3 2.5" Chassis Front I/O BP2 Gen5 NVMe Cable Kit • 4X97A90342, ThinkSystem SR650 V3 2.5" Chassis Front I/O BP2 NVMe Cable Kit
37	8	0	8	0	0	0	0	0	0	0	0	<ul style="list-style-type: none"> • 4XH7A60930, ThinkSystem V3 2U 8x2.5" SAS/SATA Backplane Option Kit • 4XH7A61076, ThinkSystem V2/V3 2U 8x2.5" NVMe Backplane Option Kit • 4X97A82933, ThinkSystem SR650 V3 2.5" Chassis Front BP1 SAS/SATA Cable Kit • 4X97A90342, ThinkSystem SR650 V3 2.5" Chassis Front I/O BP2 NVMe Cable Kit
100	0	8	0	0	0	0	0	0	0	0	0	<ul style="list-style-type: none"> • 4XH7A86660, ThinkSystem V3 2U 8x2.5" AnyBay Backplane Gen5 Option Kit • 4X97A82933, ThinkSystem SR650 V3 2.5" Chassis Front BP1 SAS/SATA Cable Kit • 4X97A88458, ThinkSystem SR650 V3 2.5" Chassis Front BP1 Gen5 NVMe Cable Kit
101	0	0	8	0	0	0	0	0	0	0	0	<ul style="list-style-type: none"> • 4XH7A87748, ThinkSystem V3 2U 8x2.5" NVMe Backplane Gen5 Option Kit • 4X97A88458, ThinkSystem SR650 V3 2.5" Chassis Front BP1 Gen5 NVMe Cable Kit
102	0	0	16	0	0	0	0	0	0	0	0	<ul style="list-style-type: none"> • 4XH7A87748, ThinkSystem V3 2U 8x2.5" NVMe Backplane Gen5 Option Kit • 4XH7A87748, ThinkSystem V3 2U 8x2.5" NVMe Backplane Gen5 Option Kit • 4X97A88458, ThinkSystem SR650 V3 2.5" Chassis Front BP1 Gen5 NVMe Cable Kit • 4X97A90343, ThinkSystem SR650 V3 2.5" Chassis Front I/O BP2 SAS/SATA Cable Kit

Upgrading to an internal (CFF) adapter

If you want to add an internal (CFF) storage adapter (HBA, RAID adapter or SAS expander) to a configuration, you will need to order the cable kit as listed in the following table. Suitable upgrades are either replacing an existing adapter in a rear PCIe slot, or adding the CFF adapter to a server without any storage adapter installed.

The cable kit to order is listed in the following table.

Table 40. Cable kit when upgrading to an Internal HBA/RAID adapter

Part number	Description
4X97A82941	ThinkSystem SR650 V3 Internal HBA/RAID Adapter Cable Kit

The cable kit includes the cables need to connect to backplanes. Contents of the kit is listed in the following page:

https://serveroption.lenovo.com/cable_kit_options/cable_kit_sr650v3_internal_hba_raid_adapter

When adding drive bays, you will also need to add the appropriate CFF storage controller.

2.5-inch drive bay fillers

Backplane option kits include the necessary drive bay fillers, however if needed, additional blanks can be ordered as listed in the following table.

Table 41. Drive bay fillers for 2.5-inch bays

Part number	Description
4XH7A99569	ThinkSystem 2.5" 1x1 HDD Filler by 8 units (contains 8x single drive-bay fillers)

RAID flash power module (supercap) support

If you plan to add one of the RAID adapters that includes a RAID flash power module (supercap) as a field upgrade, then you may also need to order a Supercap installation kit for the supercap, depending on the location where the supercap will be installed. For CTO orders, the components needed are automatically derived when you select the RAID adapter.

The adapters that this applies to are as follows:

- Any supported RAID 9350 adapter
- Any supported RAID 940 adapter

The location of the supercaps depends on the mid-chassis drive cage used in the server, as shown in the following table.

Table 42. Supercap support

Mid drive cage	Supercaps supported	Location of supercaps	Supercap holder
No mid drive cage	4	Mounted on the air baffle	Not needed
2.5-inch drives	2	Mounted on the left side of the mid drive cage	Integrated into the left side of the 2.5-inch mid drive cage
3.5-inch drives	1	Mounted under the system fan cage	Included with the server or part of ThinkSystem SR650 V3 Middle 4x3.5" SAS/SATA Backplane Option Kit (4XH7A82916) (see below)

For 3.5-inch drive bay configurations, if the server already has 3.5-inch mid-chassis drive bays, then the supercap holder is already present under the system fan cages. If you plan to add 3.5-inch mid-chassis drive bays by adding ThinkSystem SR650 V3 Middle 4x3.5" SAS/SATA Backplane Option Kit (4XH7A82916), then the supercap holder is part of the option kit.

7mm drives

The SR650 V3 supports two 7mm drives, either both SATA or both NVMe, at the rear of the server. These drives go in place of either PCIe slot 3 (Riser 1) or PCIe slot 6 (Riser 2) as shown in the following figure.

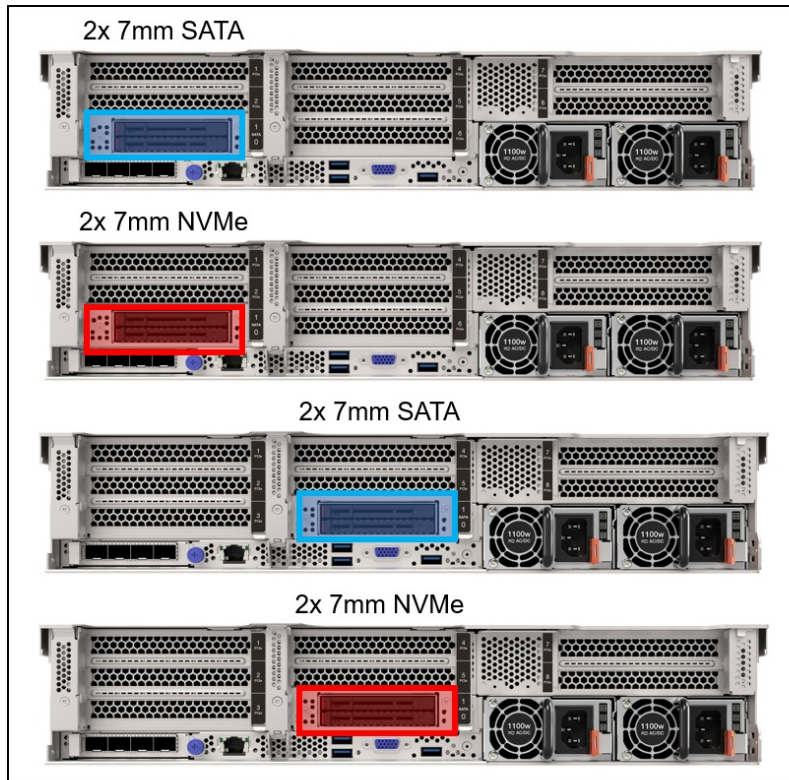

Figure 16. Rear 7mm drive bay configurations

For CTO orders, the configuration includes the drive bays and the cage the the drive bays are mounted on to. The cage required depends on where the 7mm drives are located (Riser 1 or Riser 2) and whether there are PCIe slots above the 7mm drive bays. The following table lists the ordering information.

Table 43. CTO feature code for 7mm drives

Feature code	Description	Maximum supported
Backplane - 7mm drives		
BU0N	ThinkSystem 7mm SATA/NVMe 2-Bay Rear Enablement Kit v2	1
B8P3	ThinkSystem 2U 7mm Drive Kit w/ NVMe RAID (Marvell RAID)	1
BYFG	ThinkSystem 7mm SATA/NVMe 2-Bay Rear Hot-Swap RAID Enablement Kit (Broadcom RAID)	1
VROC RAID support for ThinkSystem 7mm SATA/NVMe 2-Bay Rear Enablement Kit v2 (BU0N) (optional)		
BS7U	On Board SATA Software RAID Mode for 7mm (VROC SATA)	1
BS7R	Intel VROC (VMD NVMe RAID) Standard for 7mm (VROC NVMe)	1
Hardware RAID support for ThinkSystem 7mm SATA/NVMe 2-Bay Rear Enablement Kit v2 (BU0N) (optional; an alternative to VROC)		
BVL2	ThinkSystem RAID 5350-8i for 7MM SATA boot Enablement	1
BW1V	ThinkSystem RAID 5350-8i Internal Adapter for 7MM SATA boot Enablement	
BVL4	ThinkSystem RAID 540-8i for 7MM NVMe boot Enablement	1

The use of the 7mm rear drive bays has the following configuration rules:

- The 7mm rear drive kit is supported in either slot 3 or slot 6 but not both at the same time.
- 7mm drive bays are not supported in configurations with 4x 2.5-inch rear drive bays, as they use the

same power connector

- M.2 and 7mm are mutually exclusive: they are not supported together in the same configuration
- For ThinkSystem 7mm SATA/NVMe 2-Bay Rear Enablement Kit v2 (feature BU0N):
 - The 7mm drive bays support either SATA drives or NVMe drives but not both. You specify SATA or NVMe in the configurator using feature codes BTTV (SATA) or BTTW (NVMe).
 - RAID support is implemented using VROC (no adapter needed) or with the use of an additional RAID adapter installed in a slot
 - If RAID is enabled using VROC, select these feature codes:
 - VROC SATA support: On Board SATA Software RAID Mode for 7mm (feature BS7U)
 - VROC NVMe support:
 - Intel VROC (VMD NVMe RAID) Standard for 7mm (feature BS7R)
 - Intel VROC RAID1 Only for 7mm (feature BZ4Y)
 - If RAID is enabled using a RAID adapter, the adapter is installed in any of PCIe slots 1-6:
 - RAID support for 7mm SATA drives requires a RAID 5350-8i adapter (feature BVL2)
 - RAID support for 7mm NVMe drives requires a RAID 540-8i adapter operating in Tri-Mode (feature BVL4)
 - The use of VROC SATA RAID is not supported by virtualization hypervisors such as ESXi, KVM, Xen, and Hyper-V. VROC NVMe RAID is supported by hypervisors, however.
- For ThinkSystem 2U 7mm Drive Kit w/ NVMe RAID (feature B8P3)
 - The adapter only supports NVMe drives
 - RAID functionality is integrated into the 7mm adapter using a Marvell 88NR2241 NVMe RAID Controller
- For ThinkSystem 7mm SATA/NVMe 2-Bay Rear Hot-Swap RAID Enablement Kit (feature BYFG)
 - The adapter supports either SATA or NVMe drives
 - RAID functionality is integrated into the 7mm adapter using a Broadcom RAID Controller

7mm drive field upgrades

For field upgrades, using the following ordering information. The kit includes two cages for use depending on your PCIe slot configuration. The cages are for either Riser 1 or Riser 2.

HW RAID support: The 7mm Enablement Kit part numbers below do not include the RAID adapter optionally used for 7mm HW RAID support. If you wish to enable hardware RAID support for 7mm, you will need to order either the 5350-8i for SATA RAID support or 540-8i for NVMe RAID support. In addition, the 540-8i, once installed, will need to be configured to operate in Tri-mode to enable NVMe RAID.

Table 44. Field upgrade part number for 7mm drives

Part number	Description	Purpose
7mm Enablement Kits		
4XH7A87068	ThinkSystem SR650 V3 7mm SATA/NVMe 2-Bay Non-Raid Enablement Kit <ul style="list-style-type: none"> • 2-bay SATA/NVMe hot-swap drive enclosure • 1x 2FH+7mm SSD Riser cages (with 2 FH PCIe slots) • 7mm SSD Riser Cage (without PCIe slots) • 2x 7mm drive bay fillers • Signal and power cables for onboard connections 	7mm drive bays for SATA or NVMe drive support. Optional RAID support using VROC SATA or VROC NVMe (does not include cables needed for RAID support)
4XH7A88465	ThinkSystem SR650 V3 7mm SATA/NVMe SFF RAID Enablement Kit <ul style="list-style-type: none"> • 2-bay SATA hot-swap drive enclosure • 2FH+7mm SSD Riser Cage (with 2 FH PCIe slots) • 7mm SSD Riser Cage (without PCIe slots) • 2x 7mm drive bay fillers • Signal and power cables for RAID adapter connectivity 	7mm drive bays for SATA or NVMe drives, plus cables for use with a RAID adapter. Requires a separate RAID adapter for RAID support.
4XH7A88463	ThinkSystem SR650 V3 7mm NVMe 2-Bay RAID Enablement Kit	7mm drive bays for NVMe drive support. RAID support is integrated into the adapter using an onboard Marvell 88NR2241 NVMe RAID controller.
4XH7A93807	ThinkSystem SR650 V3 7mm RAID B540p-2HS SATA/NVMe Enablement Kit	7mm drive bays for NVMe drive support. RAID support is integrated into the adapter using an onboard Broadcom RAID controller.
4X97A90536	ThinkSystem SR650 V3 x4 M.2/7mm CFF RAID Cable Kit	Cable kit when adding 7mm drives and connecting to an internal (CFF) RAID adapter instead of a regular PCIe (SFF) RAID adapter. Requires 4XH7A88465.
RAID adapters for optional 7mm HW RAID support (for use with 4XH7A88465)		
4Y37A72482	ThinkSystem RAID 5350-8i PCIe 12Gb Adapter	RAID adapter for SATA RAID-1 with 2x 7mm SATA drives
4Y37A78834	ThinkSystem RAID 540-8i PCIe Gen4 12Gb Adapter	RAID adapter for NVMe RAID-1 with 2x 7mm NVMe drives Tip: Once the 540-8i adapter is installed, it will need to be configured to operate in Tri-mode to enable NVMe RAID.

M.2 drives

The SR650 V3 supports one or two M.2 form-factor SATA or NVMe drives for use as an operating system boot solution or as additional storage.

The M.2 drives install into an M.2 module which is mounted horizontally in the server in front of the fans as shown in the [Internal view](#) of the server. In configurations with 2.5-inch front drive bays, the M.2 module is position between the drive bays and the fans. In configurations with 3.5-inch front drive bays, the M.2 module is mounted on top of the front drive bays.

The supported M.2 module is listed in the following table. For field upgrades see the [M.2 field upgrades](#) section below.

Table 45. M.2 modules

Part number	Feature code	Description	SATA drives	NVMe drives	RAID	Maximum supported	Windows 10/11 support
4Y37A79663	BM8X	ThinkSystem M.2 SATA/x4 NVMe 2-Bay Adapter	Yes	Yes (x4 lanes)	VROC or adapter	1	Supported
4Y37A09750	B8P9	ThinkSystem M.2 NVMe 2-Bay RAID Adapter	No	Yes (x1 lane)	Integrated (Marvell)	1	No
4Y37A90063	BYFF	ThinkSystem M.2 RAID B540i-2i SATA/NVMe Adapter	Yes	Yes (x1 lane)	Integrated (Broadcom)	1	Supported

ThinkSystem M.2 SATA/x4 NVMe 2-Bay Adapter (4Y37A79663) optionally supports RAID with the addition of either VROC or a separate RAID adapter. For CTO orders, ordering information is listed in the following table.

Table 46. CTO feature codes to select M.2 RAID (ThinkSystem M.2 SATA/x4 NVMe 2-Bay Adapter only)

Feature code	Description	RAID support	Maximum supported
VROC for M.2 drives (optional, for RAID support)			
BS7Q	On Board SATA Software RAID Mode for M.2 (VROC SATA)	SATA	1
BS7M	Intel VROC (VMD NVMe RAID) Standard for M.2 (VROC NVMe)	NVMe	1
Controllers for RAID support of M.2 drives (optional; an alternative to VROC)			
BVL1	ThinkSystem RAID 5350-8i for M.2 SATA boot Enablement	SATA	1
BW1U	ThinkSystem RAID 5350-8i Internal Adapter for M.2 SATA boot Enablement	SATA	1
BVL3	ThinkSystem RAID 540-8i for M.2 NVMe boot Enablement	NVMe	1

Configuration notes:

- M.2 is not supported with all storage configurations - see [Storage configurations](#) for details.
- M.2 and 7mm are mutually exclusive: they are not supported together in the same configuration
- For field upgrades, an additional cable is needed as described in the [M.2 field upgrades](#) section below
- For ThinkSystem M.2 SATA/x4 NVMe 2-Bay Adapter (4Y37A79663):
 - RAID support is implemented using VROC (no adapter needed) or with the use of an additional RAID adapter installed in a slot
 - If RAID is enabled using VROC, select these feature codes:
 - VROC SATA support: On Board SATA Software RAID Mode for M.2 (feature BS7Q)
 - VROC NVMe support:
 - Intel VROC (VMD NVMe RAID) Standard for M.2 (feature BS7M)
 - Intel VROC RAID1 Only for M.2 (feature BZ4X)
 - If RAID is enabled using a RAID adapter, the adapter is installed in in any of PCIe slots 1-6:
 - RAID support for M.2 SATA drives requires a RAID 5350-8i adapter (feature BVL1)
 - RAID support for M.2 NVMe drives requires a RAID 540-8i adapter operating in Tri-Mode (feature BVL3)
 - The adapter is not supported with 3.5-inch mid-chassis drive bays due to physical limitations
 - The use of VROC SATA RAID is not supported by virtualization hypervisors such as ESXi, KVM, Xen, and Hyper-V. VROC NVMe RAID is supported by hypervisors, however.
- For ThinkSystem M.2 NVMe 2-Bay RAID Adapter (4Y37A09750):
 - RAID is implemented using an onboard Marvell 88NR2241 NVMe RAID controller
- For ThinkSystem M.2 RAID B540i-2i SATA/NVMe Adapter (4Y37A90063):

- RAID is implemented using an onboard Broadcom RAID controller

The ThinkSystem M.2 SATA/x4 NVMe 2-Bay Adapter has the following features:

- Supports one or two M.2 drives, either SATA or NVMe
- When two drives installed, they must be either both SATA or both NVMe
- Support 42mm, 60mm, 80mm and 110mm drive form factors (2242, 2260, 2280 and 22110)
- On the SR650 V3, RAID support is implemented using VROC or a separate RAID adapter
- Either 6Gbps SATA or PCIe 4.0 x4 interface to the drives depending on the drives installed
- Supports monitoring and reporting of events and temperature through I2C
- Firmware update via Lenovo firmware update tools
- When connected to a separate PCIe RAID adapter, supports SED drive encryption via the RAID adapter, otherwise no SED support

The ThinkSystem M.2 NVMe 2-Bay RAID Adapter (4Y37A09750) has the following features:

- Supports one or two NVMe M.2 drives
- Support 42mm, 60mm, 80mm and 110mm drive form factors (2242, 2260, 2280 and 22110)
- RAID support via an onboard Marvell 88NR2241 NVMe RAID Controller
- With 1 drive, supports single-drive RAID-0
- With 2 drives, supports 2-drive RAID-0, 2-drive RAID-1, or two single-drive RAID-0 arrays
- PCIe 3.0 x2 host interface; PCIe 3.0 x1 connection to each drive
- Management and configuration support via UEFI and OS-based tools
- Supports monitoring and reporting of events and temperature through I2C
- Firmware update via Lenovo firmware update tools
- No support for SED drive encryption

The ThinkSystem M.2 RAID B540i-2i SATA/NVMe Adapter (4Y37A90063) has the following features:

- Supports one or two M.2 drives, either SATA or NVMe
- Support 42mm, 60mm, 80mm and 110mm drive form factors (2242, 2260, 2280 and 22110)
- RAID support via an onboard Broadcom SAS3808N RAID Controller
- With 1 drive, supports JBOD
- With 2 drives, supports 2-drive RAID-0, 2-drive RAID-1, or JBOD
- PCIe 4.0 x2 host interface; PCIe 4.0 x1 connection to each drive
- Management and configuration support via UEFI and OS-based tools
- Supports monitoring and reporting of events and temperature
- Firmware update via Lenovo firmware update tools
- Supports SED drive encryption

M.2 field upgrades

For field upgrades, the SR650 V3 also requires an additional M.2 cable kit. Ordering information is listed in the following table.

Table 47. M.2 Cable Kits for field upgrades

Part number	Description	Purpose
M.2 Cable kits		
4X97A82924	ThinkSystem SR650 V3 x4 M.2 SATA/NVMe Non-RAID Cable Kit	Cable kit for ThinkSystem M.2 SATA/x4 NVMe 2-Bay Adapter (4Y37A79663) directly connect to system board (either no RAID, or VROC RAID)
4X97A88464	ThinkSystem SR650 V3 M.2 SATA/x4 NVMe SFF RAID Cable Kit	Cable kit for ThinkSystem M.2 SATA/x4 NVMe 2-Bay Adapter (4Y37A79663) connected to a PCIe RAID adapter
4X97A90536	ThinkSystem SR650 V3 x4 M.2/7mm CFF RAID Cable Kit	Cable kit for ThinkSystem M.2 SATA/x4 NVMe 2-Bay Adapter (4Y37A79663) connected to a Internal (CFF) RAID adapter
4X97A82925	ThinkSystem SR650 V3 M.2 NVMe 2-Bay RAID Cable Kit	Cable kit for ThinkSystem M.2 NVMe 2-Bay RAID Adapter (4Y37A09750)
4X97A93808	ThinkSystem SR650 V3/SR655 V3 M.2 RAID B540i-2i SATA/NVMe Cable Kit	Cable kit for ThinkSystem M.2 RAID B540i-2i SATA/NVMe Adapter (4Y37A90063)
RAID adapters for M.2 RAID support (4Y37A79663 only)		
4Y37A72482	ThinkSystem RAID 5350-8i PCIe 12Gb Adapter	RAID adapter to provide M.2 SATA RAID support
4Y37A78834	ThinkSystem RAID 540-8i PCIe Gen4 12Gb Adapter	RAID adapter to provide M.2 NVMe support using Tri-Mode Tip: Once the 540-8i adapter is installed, it will need to be configured to operate in Tri-mode to enable NVMe RAID.

SED encryption key management with SKLM

The server supports self-encrypting drives (SEDs) as listed in the [Internal drive options](#) section. To effectively manage a large deployment of these drives in Lenovo servers, IBM Security Key Lifecycle Manager (SKLM) offers a centralized key management solution.

A Lenovo Feature on Demand (FoD) upgrade is used to enable this SKLM support in the management processor of the server. The following table lists the part numbers and feature codes for the upgrades.

Table 48. FoD upgrades for SKLM support

Part number	Feature code	Description
Security Key Lifecycle Manager - FoD (United States, Canada, Asia Pacific, and Japan)		
00D9998	A5U1	SKLM for System x/ThinkSystem w/SEDs - FoD per Install with 1 year S&S
00D9999	AS6C	SKLM for System x/ThinkSystem w/SEDs - FoD per Install with 3 year S&S
Security Key Lifecycle Manager - FoD (Latin America, Europe, Middle East, and Africa)		
00FP648	A5U1	SKLM for System x/ThinkSystem w/SEDs - FoD per Install with 1 year S&S
00FP649	AS6C	SKLM for System x/ThinkSystem w/SEDs - FoD per Install with 3 year S&S

The IBM Security Key Lifecycle Manager software is available from Lenovo using the ordering information listed in the following table.

Table 49. IBM Security Key Lifecycle Manager licenses

Part number	Description
7S0A007FWW	IBM Security Key Lifecycle Manager Basic Edition Install License + SW Subscription & Support 12 Months
7S0A007HWW	IBM Security Key Lifecycle Manager For Raw Decimal Terabyte Storage Resource Value Unit License + SW Subscription & Support 12 Months
7S0A007KWW	IBM Security Key Lifecycle Manager For Raw Decimal Petabyte Storage Resource Value Unit License + SW Subscription & Support 12 Months
7S0A007MWW	IBM Security Key Lifecycle Manager For Usable Decimal Terabyte Storage Resource Value Unit License + SW Subscription & Support 12 Months
7S0A007PWW	IBM Security Key Lifecycle Manager For Usable Decimal Petabyte Storage Resource Value Unit License + SW Subscription & Support 12 Months

Controllers for internal storage

The SR650 V3 offers a variety of controller options for internal drives:

- For 2.5-inch and 3.5-inch drives:
 - Onboard SATA ports with software RAID support (Intel VROC SATA RAID, formerly known as Intel RSTe)
 - Onboard NVMe ports with software RAID support (Intel VROC NVMe RAID)
 - RAID adapters and HBAs for SAS/SATA drives (PCIe slot-based)
 - RAID adapters and HBAs for SAS/SATA drives (cabled in a dedicated space)
- For 7mm drive bays in the rear of the server (see the [7mm drives](#) section)
 - SATA controller integrated into the 7mm drive bay enclosure
 - NVMe controller integrated into the 7mm drive bay enclosure (Intel VROC for RAID)
- For M.2 drives internal to the server (see [M.2 drives](#) section)
 - SATA controller integrated on the M.2 adapters
 - NVMe controller integrated on the M.2 adapters (Intel VROC for RAID)

As well as supporting RAID adapters and HBAs that install in a PCIe slot, the SR650 V3 with 2.5-inch front drive bays supports a custom form factor (CFF) adapter that is mounted in the server and cabled to one of the onboard NVMe ports. CFF adapters are not supported with 3.5-inch front drives due to a lack of physical space.

The following table lists the adapters used for the internal storage of the server.

Table 50. Internal Storage adapter support

Part number	Feature code	Description	Maximum supported	Slots supported	Windows 10/11 support
Onboard SATA - up to 14 drives - Intel VROC SATA RAID (Intel RSTe)					
None	AVV0	On Board SATA Software RAID Mode	1	Not applicable	Supported
Onboard NVMe - up to 20 drives - Intel VROC NVMe RAID					
None	BR9B	Intel VROC (VMD NVMe RAID) Standard (supports RAID 0, 1, 10 for all brands of drives)	1	Not applicable	Supported
4L47A39164	B96G	Intel VROC (VMD NVMe RAID) Premium (license upgrade - to enable RAID-5 support)	1	Not applicable	Supported
SAS HBA - PCIe 3.0					
4Y37A72480	BJHH**	ThinkSystem 4350-8i SAS/SATA 12Gb HBA	4	1,2,3,4,5,6	No
4Y37A72481	BJHJ	ThinkSystem 4350-16i SAS/SATA 12Gb HBA	2	1,2,3,4,5,6	No
SAS HBA - PCIe 4.0					

Part number	Feature code	Description	Maximum supported	Slots supported	Windows 10/11 support
4Y37A78601	BM51	ThinkSystem 440-8i SAS/SATA PCIe Gen4 12Gb HBA	4	1,2,3,4,5,6	No
4Y37A78602	BM50	ThinkSystem 440-16i SAS/SATA PCIe Gen4 12Gb HBA	2	1,2,3,4,5,6	No
4Y37A09725	B8P1	ThinkSystem 440-16i SAS/SATA PCIe Gen4 12Gb Internal HBA	1	CFF bay	No
RAID Adapter - PCIe 3.0					
4Y37A72482	BJHK	ThinkSystem RAID 5350-8i PCIe 12Gb Adapter	4	1,2,3,4,5,6	Supported
4Y37A84028	BRQV	ThinkSystem RAID 5350-8i PCIe 12Gb Internal Adapter	1	CFF bay	Supported
4Y37A72483	BJHL	ThinkSystem RAID 9350-8i 2GB Flash PCIe 12Gb Adapter	4	1,2,3,4,5,6	Supported
4Y37A72484	BJHM	ThinkSystem RAID 9350-8i 2GB Flash PCIe 12Gb Internal Adapter	1	CFF bay	Supported
4Y37A72485	BJHN	ThinkSystem RAID 9350-16i 4GB Flash PCIe 12Gb Adapter	2	1,2,3,4,5,6	Supported
4Y37A72486	BJHP**	ThinkSystem RAID 9350-16i 4GB Flash PCIe 12Gb Internal Adapter	1	CFF bay	Supported
RAID Adapter - PCIe 4.0					
4Y37A78834	BMFT	ThinkSystem RAID 540-8i PCIe Gen4 12Gb Adapter	4	1,2,3,4,5,6	Supported
4Y37A78835	BNAX	ThinkSystem RAID 540-16i PCIe Gen4 12Gb Adapter	2	1,2,3,4,5,6	Supported
4Y37A09728†	B8NY	ThinkSystem RAID 940-8i 4GB Flash PCIe Gen4 12Gb Adapter	4	1,2,3,4,5,6	Supported
4Y37A09729§	B8NW	ThinkSystem RAID 940-8i 8GB Flash PCIe Gen4 12Gb Adapter	4	1,2,3,4,5,6	Supported
4Y37A78600†	BM35	ThinkSystem RAID 940-16i 4GB Flash PCIe Gen4 12Gb Adapter	2	1,2,3,4,5,6	Supported
4Y37A09730†	B8NZ	ThinkSystem RAID 940-16i 8GB Flash PCIe Gen4 12Gb Adapter	2	1,2,3,4,5,6	Supported
4Y37A09735	B8P0	ThinkSystem RAID 940-16i 8GB Flash PCIe Gen4 12Gb Internal Adapter	1	CFF bay	Supported
4Y37A09733	B8P8	ThinkSystem RAID 940-32i 8GB Flash PCIe Gen4 12Gb Adapter	1	1,2,3,4,5,6	Supported
SAS expander					
4Y37A09736	B8P6	ThinkSystem 48 port 12Gb Internal Expander	1	CFF bay	Supported
NVMe					
4C57A65446	B98C	ThinkSystem 4-Port PCIe Gen4 NVMe Retimer Adapter	4	1,2,3,4,5,6	Supported
4TA7A84579	BLKY	ThinkSystem PCIe Gen5 NVMe Retimer Adapter	4	1,2,3,4,5,6	Supported
4Y37A09728†	BGM1	ThinkSystem RAID 940-8i 4GB Flash PCIe Gen4 12Gb Adapter for U.3	3	1,2,3,4,5,6	Supported
4Y37A78600†	BM36	ThinkSystem RAID 940-16i 4GB Flash PCIe Gen4 12Gb Adapter for U.3	1	1,2,3,4,5,6	Supported
4Y37A09730†	BDY4	ThinkSystem RAID 940-16i 8GB Flash PCIe Gen4 12Gb Adapter for U.3	1	1,2,3,4,5,6	Supported

* Only supported with 2.5-inch front drive bays. Not supported in configurations with 3.5-inch front drive bays.

† Adapter also supports PCIe 4.0 x1 connectivity to NVMe drives (requires NVMe drives with U.3 interface)

‡ Internal adapters (CFF) do not occupy any of the rear slots.

** This adapter is currently not available for CTO orders; it is only available as an option part number for field upgrades

§ Planned for December 2024

Configuration notes:

- **VROC NVMe RAID support:** Some 5th Gen Intel Xeon Scalable processors do not support Intel VROC NVMe RAID. See the [Intel VROC NVMe RAID](#) section for specifics.
- **Supercap support limits the number of RAID adapters installable:** RAID 9350 and 940 adapters include a power module (supercap) to power the flash memory. The server supports between 1 and 4 supercaps depending on the server configuration as described in the [RAID flash power module \(supercap\) support](#) section. The number of supercaps supported also determines the maximum number of RAID adapters with flash that can be installed in the server.
- **Field upgrades:** If you are adding a RAID adapter with supercap to the server as a field upgrade, you may need a supercap holder as described in the [RAID flash power module \(supercap\) support](#) section.
- **7mm drive support:** The storage adapters listed in the table below do *not* provide connectivity to the 7mm drive bays that are optionally available at the rear of the server. The 7mm drives have their own independent RAID controller. See the [7mm drives](#) section for details.
- **E810 Ethernet and X350 RAID/HBAs:** The use of both an Intel E810 network adapter and an X350 HBA/RAID adapter (9350, 5350 and 4350) is supported, however E810 firmware CVL4.3 or later is required. For details, see [Support Tip HT513226](#).

The RAID 940-8i and RAID 940-16i adapters also support NVMe through a feature named Tri-Mode support (or Trimode support). This feature enables the use of NVMe U.3 drives at the same time as SAS and SATA drives. Tri-Mode requires an AnyBay backplane. Cabling of the controller to the backplanes is the same as with SAS/SATA drives, and the NVMe drives are connected via a PCIe x1 link to the controller.

NVMe drives connected using Tri-Mode support provide better performance than SAS or SATA drives: A SATA SSD has a data rate of 6Gbps, a SAS SSD has a data rate of 12Gbps, whereas an NVMe U.3 Gen 4 SSD with a PCIe x1 link will have a data rate of 16Gbps. NVMe drives typically also have lower latency and higher IOPS compared to SAS and SATA drives. Tri-Mode is supported with U.3 NVMe drives and requires an AnyBay backplane.

Tri-Mode requires U.3 drives: Only NVMe drives with a U.3 interface are supported. U.2 drives are not supported. See the [Internal drive options](#) section for the U.3 drives supported by the server.

The onboard SATA controller has the following features:

- Controller integrated into the Intel PCH
- 6 Gbps SATA host interface
- Supports up to 14x SATA drives
- Supports RAID-0, 1, 5, 10 (Intel VROC SATA RAID, previously known as RSTe)
- Supports JBOD
- Supports HDDs and SSDs; can be mixed

The onboard NVMe support has the following features:

- Controller integrated into the Intel processor
- Supports up to 20x NVMe drives direct connected to onboard ports; additional drives through retimer/switch adapters
- Each drive has PCIe 5.0 x4 host interface
- Supports JBOD - Intel and non-Intel NVMe SSDs
- Supports RAID-0, 1, 10 on Intel and non-Intel NVMe SSDs - Intel VROC Standard
- VROC Premium adds RAID-5 support on Intel and non-Intel NVMe SSDs

Intel VROC onboard RAID

Intel VROC (Virtual RAID on CPU) is a feature of the Intel processor that enables Integrated RAID support.

There are two separate functions of VROC in the SR650 V3:

- Intel VROC SATA RAID, formerly known as Intel RSTe
- Intel VROC NVMe RAID

VROC SATA RAID (RSTe) is available and supported with all SATA drives. It offers a 6 Gb/s connection to each drive and on the SR650 V3 implements RAID levels 0, 1, 5, and 10. RAID 1 is limited to 2 drives per array, and RAID 10 is limited to 4 drives per array. Hot-spare functionality is also supported.

VROC NVMe RAID offers RAID support for any NVMe drives directly connected to the ports on the server's system board or via adapters such as NVMe retimers or NVMe switch adapters. On the SR650 V3, RAID levels implemented are based on the VROC feature selected as indicated in the following table. RAID 1 is limited to 2 drives per array, and RAID 10 is limited to 4 drives per array. Hot-spare functionality is also supported.

Performance tip: For best performance with VROC NVMe RAID, the drives in an array should all be connected to the same processor. Spanning processors is possible however performance will be unpredictable and should be evaluated based on your workload.

The SR650 V3 supports the VROC NVMe RAID offerings listed in the following table.

Tip: These feature codes and part numbers are only for VROC RAID using NVMe drives, not SATA drives

Table 51. Intel VROC NVMe RAID ordering information and feature support

Part number	Feature code	Description	Intel NVMe SSDs	Non-Intel NVMe SSDs	RAID 0	RAID 1	RAID 10	RAID 5
4L47A92670	BZ4W	Intel VROC RAID1 Only	Yes	Yes	No	Yes	No	No
4L47A83669	BR9B	Intel VROC (VMD NVMe RAID) Standard	Yes	Yes	Yes	Yes	Yes	No
4L47A39164	B96G	Intel VROC (VMD NVMe RAID) Premium	Yes	Yes	Yes	Yes	Yes	Yes

Configuration notes:

- If a feature code is ordered in a CTO build, the VROC functionality is enabled in the factory. For field upgrades, order a part number and it will be fulfilled as a Feature on Demand (FoD) license which can then be activated via the XCC management processor user interface.
- The following 5th Gen Intel Xeon Scalable processors do not support Intel VROC RAID1 Only (4L47A92670, BZ4W); Only VROC Standard and VROC Premium are supported:
 - Intel Xeon Bronze 3508U 8C 125W 2.1GHz Processor
 - Intel Xeon Silver 4509Y 8C 125W 2.6GHz Processor
 - Intel Xeon Silver 4510 12C 150W 2.4GHz Processor
 - Intel Xeon Silver 4510T 12C 115W 2.0GHz Processor

Virtualization support: Virtualization support for Intel VROC is as follows:

- **VROC SATA RAID (RSTe):** VROC SATA RAID is supported with Windows, RHEL and SLES, however it is not supported by virtualization hypervisors such as ESXi, KVM, Xen, and Hyper-V. Virtualization is only supported on the onboard SATA ports in AHCI (non-RAID) mode.
- **VROC (VMD) NVMe RAID :** VROC (VMD) NVMe RAID is supported by ESXi, KVM, Xen, and Hyper-V. ESXi support is limited to RAID 1 only; other RAID levels are not supported. Windows and Linux OSes support VROC RAID NVMe, both for host boot functions and for guest OS function, and RAID-0, 1, 5, and 10 are supported. On ESXi, VROC is supported with both boot and data drives.

For specifications about the RAID adapters and HBAs supported by the SR650 V3, see the ThinkSystem RAID Adapter and HBA Comparison, available from:

<https://lenovopress.com/lp1288-lenovo-thinksystem-raid-adapter-and-hba-reference#sr650-v3-support=SR650%2520V3>

For details about these adapters, see the relevant product guide:

- SAS HBAs: <https://lenovopress.com/servers/options/hba>
- RAID adapters: <https://lenovopress.com/servers/options/raid>

Internal drive options

The following tables list the drive options for internal storage of the server.

2.5-inch hot-swap drives:

- [2.5-inch hot-swap 12 Gb SAS HDDs](#)
- [2.5-inch hot-swap 24 Gb SAS SSDs](#)
- [2.5-inch hot-swap 12 Gb SAS SSDs](#)
- [2.5-inch hot-swap 6 Gb SATA SSDs](#)
- [2.5-inch hot-swap PCIe 5.0 NVMe SSDs](#)
- [2.5-inch hot-swap PCIe 4.0 NVMe SSDs](#)

2.5-inch 7mm hot-swap drives:

- [7mm 2.5-inch hot-swap 6 Gb SATA SSDs](#)
- [7mm 2.5-inch hot-swap PCIe 4.0 NVMe SSDs](#)

3.5-inch hot-swap drives:

- [3.5-inch hot-swap 12 Gb SAS HDDs](#)
- [3.5-inch hot-swap 6 Gb SATA HDDs](#)
- [3.5-inch hot-swap 24 Gb SAS SSDs](#)
- [3.5-inch hot-swap 12 Gb SAS SSDs](#)
- [3.5-inch hot-swap 6 Gb SATA SSDs](#)
- [3.5-inch hot-swap PCIe 4.0 NVMe SSDs](#)

M.2 drives:

- [M.2 SATA drives](#)
- [M.2 PCIe 4.0 NVMe drives](#)

M.2 drive support: The use of M.2 drives requires an additional adapter as described in the [M.2 drives](#) subsection.

SED support: The tables include a column to indicate which drives support SED encryption. The encryption functionality can be disabled if needed. Note: Not all SED-enabled drives have "SED" in the description.

Table 52. 2.5-inch hot-swap 12 Gb SAS HDDs

Part number	Feature code	Description	SED support	Max Qty
2.5-inch hot-swap HDDs - 12 Gb SAS 15K				
7XB7A00021	AULV	ThinkSystem 2.5" 300GB 15K SAS 12Gb Hot Swap 512n HDD	No	40
7XB7A00022	AULW	ThinkSystem 2.5" 600GB 15K SAS 12Gb Hot Swap 512n HDD	No	40
7XB7A00023	AULX	ThinkSystem 2.5" 900GB 15K SAS 12Gb Hot Swap 512e HDD	No	40
2.5-inch hot-swap HDDs - 12 Gb SAS 10K				
7XB7A00025	AULZ	ThinkSystem 2.5" 600GB 10K SAS 12Gb Hot Swap 512n HDD	No	40
7XB7A00027	AUM1	ThinkSystem 2.5" 1.2TB 10K SAS 12Gb Hot Swap 512n HDD	No	40
7XB7A00028	AUM2	ThinkSystem 2.5" 1.8TB 10K SAS 12Gb Hot Swap 512e HDD	No	40
4XB7A83970	BRG7	ThinkSystem 2.5" 2.4TB 10K SAS 12Gb Hot Swap 512e HDD v2	No	40
2.5-inch hot-swap SED HDDs - 12 Gb SAS 10K				
7XB7A00031	AUM5	ThinkSystem 2.5" 600GB 10K SAS 12Gb Hot Swap 512n HDD SED	Support	40
7XB7A00033	B0YX	ThinkSystem 2.5" 1.2TB 10K SAS 12Gb Hot Swap 512n HDD SED	Support	40
4XB7A84038	BRG8	ThinkSystem 2.5" 2.4TB 10K SAS 12Gb Hot Swap 512e HDD FIPS v2	Support	40

Table 53. 2.5-inch hot-swap 24 Gb SAS SSDs

Part number	Feature code	Description	SED support	Max Qty
2.5-inch hot-swap SSDs - 24 Gb SAS - Mixed Use/Mainstream (3-5 DWPD)				
4XB7A80340	BNW8	ThinkSystem 2.5" PM1655 800GB Mixed Use SAS 24Gb HS SSD	Support	40
4XB7A80341	BNW9	ThinkSystem 2.5" PM1655 1.6TB Mixed Use SAS 24Gb HS SSD	Support	40
4XB7A80342	BNW6	ThinkSystem 2.5" PM1655 3.2TB Mixed Use SAS 24Gb HS SSD	Support	40
4XB7A80343	BP3K	ThinkSystem 2.5" PM1655 6.4TB Mixed Use SAS 24Gb HS SSD	Support	40
2.5-inch hot-swap SSDs - 24 Gb SAS - Read Intensive/Entry/Capacity (<3 DWPD)				
4XB7A80318	BNWC	ThinkSystem 2.5" PM1653 960GB Read Intensive SAS 24Gb HS SSD	Support	40
4XB7A80319	BNWE	ThinkSystem 2.5" PM1653 1.92TB Read Intensive SAS 24Gb HS SSD	Support	40
4XB7A80320	BNWF	ThinkSystem 2.5" PM1653 3.84TB Read Intensive SAS 24Gb HS SSD	Support	40
4XB7A80321	BP3E	ThinkSystem 2.5" PM1653 7.68TB Read Intensive SAS 24Gb HS SSD	Support	40
4XB7A80322	BP3J	ThinkSystem 2.5" PM1653 15.36TB Read Intensive SAS 24Gb HS SSD	Support	40
4XB7A80323	BP3D	ThinkSystem 2.5" PM1653 30.72TB Read Intensive SAS 24Gb HS SSD	Support	40

Table 54. 2.5-inch hot-swap 12 Gb SAS SSDs

Part number	Feature code	Description	SED support	Max Qty
2.5-inch hot-swap SSDs - 12 Gb SAS - Write Intensive/Performance (10+ DWPD)				
4XB7A83215	BR0Z	ThinkSystem 2.5" Nytro 3750 800GB Write Intensive SAS 12Gb HS SSD	Support	40
4XB7A83216	BR0Y	ThinkSystem 2.5" Nytro 3750 1.6TB Write Intensive SAS 12Gb HS SSD	Support	40
4XB7A83217	BR0X	ThinkSystem 2.5" Nytro 3750 3.2TB Write Intensive SAS 12Gb HS SSD	Support	40
4XB7A70006	BG07	ThinkSystem 2.5" Nytro 3732 400GB Performance SAS 12Gb Hot Swap SSD	No	40

Table 55. 2.5-inch hot-swap 6 Gb SATA SSDs

Part number	Feature code	Description	SED support	Max Qty
2.5-inch hot-swap SSDs - 6 Gb SATA - Mixed Use/Mainstream (3-5 DWPD)				
4XB7A90884	BYM2	ThinkSystem 2.5" Multi Vendor 480GB Mixed Use SATA 6Gb HS SSD v2	No	40
4XB7A90885	BYM4	ThinkSystem 2.5" Multi Vendor 960GB Mixed Use SATA 6Gb HS SSD v2	No	40
4XB7A90886	BYM5	ThinkSystem 2.5" Multi Vendor 1.92TB Mixed Use SATA 6Gb HS SSD v2	No	40
4XB7A90887	BYM6	ThinkSystem 2.5" Multi Vendor 3.84TB Mixed Use SATA 6Gb HS SSD v2	No	40
4XB7A82289	BQ21	ThinkSystem 2.5" 5400 MAX 480GB Mixed Use SATA 6Gb HS SSD	Support	40
4XB7A82290	BQ24	ThinkSystem 2.5" 5400 MAX 960GB Mixed Use SATA 6Gb HS SSD	Support	40
4XB7A82291	BQ22	ThinkSystem 2.5" 5400 MAX 1.92TB Mixed Use SATA 6Gb HS SSD	Support	40
4XB7A82292	BQ23	ThinkSystem 2.5" 5400 MAX 3.84TB Mixed Use SATA 6Gb HS SSD	Support	40
4XB7A17125	BA7Q	ThinkSystem 2.5" S4620 480GB Mixed Use SATA 6Gb HS SSD	No	40
4XB7A17126	BA4T	ThinkSystem 2.5" S4620 960GB Mixed Use SATA 6Gb HS SSD	No	40
4XB7A17127	BA4U	ThinkSystem 2.5" S4620 1.92TB Mixed Use SATA 6Gb HS SSD	No	40
4XB7A17128	BK7L	ThinkSystem 2.5" S4620 3.84TB Mixed Use SATA 6Gb HS SSD	No	40
2.5-inch hot-swap SSDs - 6 Gb SATA - Read Intensive/Entry (<3 DWPD)				
4XB7A90872	BYLQ	ThinkSystem 2.5" Multi Vendor 240GB Read Intensive SATA 6Gb HS SSD v2	No	40
4XB7A90873	BYLR	ThinkSystem 2.5" Multi Vendor 480GB Read Intensive SATA 6Gb HS SSD v2	No	40
4XB7A90874	BYLS	ThinkSystem 2.5" Multi Vendor 960GB Read Intensive SATA 6Gb HS SSD v2	No	40
4XB7A90875	BYLT	ThinkSystem 2.5" Multi Vendor 1.92TB Read Intensive SATA 6Gb HS SSD v2	No	40
4XB7A90876	BYLU	ThinkSystem 2.5" Multi Vendor 3.84TB Read Intensive SATA 6Gb HS SSD v2	No	40
4XB7A90877	BYLV	ThinkSystem 2.5" Multi Vendor 7.68TB Read Intensive SATA 6Gb HS SSD v2	No	40
4XB7A87524	BWKN	ThinkSystem 2.5" PM893a 480GB Read Intensive SATA 6Gb HS SSD	Support	40
4XB7A87525	BWKM	ThinkSystem 2.5" PM893a 960GB Read Intensive SATA 6Gb HS SSD	Support	40
4XB7A87526	BWKL	ThinkSystem 2.5" PM893a 1.92TB Read Intensive SATA 6Gb HS SSD	Support	40
4XB7A87527	BWKK	ThinkSystem 2.5" PM893a 3.84TB Read Intensive SATA 6Gb HS SSD	Support	40
4XB7A87528	BYLK	ThinkSystem 2.5" PM893a 7.68TB Read Intensive SATA 6Gb HS SSD	Support	40
4XB7A82258	BQ1Q	ThinkSystem 2.5" 5400 PRO 240GB Read Intensive SATA 6Gb HS SSD	Support	40
4XB7A82259	BQ1P	ThinkSystem 2.5" 5400 PRO 480GB Read Intensive SATA 6Gb HS SSD	Support	40
4XB7A82260	BQ1R	ThinkSystem 2.5" 5400 PRO 960GB Read Intensive SATA 6Gb HS SSD	Support	40
4XB7A82261	BQ1X	ThinkSystem 2.5" 5400 PRO 1.92TB Read Intensive SATA 6Gb HS SSD	Support	40
4XB7A82262	BQ1S	ThinkSystem 2.5" 5400 PRO 3.84TB Read Intensive SATA 6Gb HS SSD	Support	40
4XB7A82263	BQ1T	ThinkSystem 2.5" 5400 PRO 7.68TB Read Intensive SATA 6Gb HS SSD	Support	40
4XB7A17072	B99D	ThinkSystem 2.5" S4520 240GB Read Intensive SATA 6Gb HS SSD	No	40
4XB7A17101	BA7G	ThinkSystem 2.5" S4520 480GB Read Intensive SATA 6Gb HS SSD	No	40
4XB7A17102	BA7H	ThinkSystem 2.5" S4520 960GB Read Intensive SATA 6Gb HS SSD	No	40
4XB7A17103	BA7J	ThinkSystem 2.5" S4520 1.92TB Read Intensive SATA 6Gb HS SSD	No	40
4XB7A17104	BK77	ThinkSystem 2.5" S4520 3.84TB Read Intensive SATA 6Gb HS SSD	No	40

Part number	Feature code	Description	SED support	Max Qty
4XB7A17105	BK78	ThinkSystem 2.5" S4520 7.68TB Read Intensive SATA 6Gb HS SSD	No	40

Table 56. 2.5-inch hot-swap PCIe 5.0 NVMe SSDs

Part number	Feature code	Description	SED support	Max Qty
2.5-inch SSDs - U.2 PCIe 5.0 NVMe - Mixed Use/Mainstream (3-5 DWPD)				
4XB7A93888	C0ZM	ThinkSystem 2.5" U.2 CD8P 1.6TB Mixed Use NVMe PCIe 5.0 x4 HS SSD	Support	32
4XB7A93889	C0ZL	ThinkSystem 2.5" U.2 CD8P 3.2TB Mixed Use NVMe PCIe 5.0 x4 HS SSD	Support	32
4XB7A93890	C0ZK	ThinkSystem 2.5" U.2 CD8P 6.4TB Mixed Use NVMe PCIe 5.0 x4 HS SSD	Support	32
4XB7A93891	C0ZJ	ThinkSystem 2.5" U.2 CD8P 12.8TB Mixed Use NVMe PCIe 5.0 x4 HS SSD	Support	32
4XB7A93127	C0ZR	ThinkSystem 2.5" U.2 Multi Vendor 1.6TB Mixed Use NVMe PCIe 5.0 x4 HS SSD	Support	32
4XB7A93128	C0ZQ	ThinkSystem 2.5" U.2 Multi Vendor 3.2TB Mixed Use NVMe PCIe 5.0 x4 HS SSD	Support	32
4XB7A93129	C0ZP	ThinkSystem 2.5" U.2 Multi Vendor 6.4TB Mixed Use NVMe PCIe 5.0 x4 HS SSD	Support	32
4XB7A93130	C0ZN	ThinkSystem 2.5" U.2 Multi Vendor 12.8TB Mixed Use NVMe PCIe 5.0 x4 HS SSD	Support	32
2.5-inch SSDs - U.3 PCIe 5.0 NVMe - Mixed Use/Mainstream (3-5 DWPD)				
4XB7A94637	C4D4	ThinkSystem 2.5" U.3 PM1745 1.6TB Mixed Use NVMe PCIe 5.0 x4 HS SSD	Support	32
2.5-inch SSDs - U.2 PCIe 5.0 NVMe - Read Intensive/Entry (<3 DWPD)				
4XB7A93480	C0BB	ThinkSystem 2.5" U.2 CD8P 1.92TB Read Intensive NVMe PCIe 5.0 x4 HS SSD	Support	32
4XB7A93481	C0BA	ThinkSystem 2.5" U.2 CD8P 3.84TB Read Intensive NVMe PCIe 5.0 x4 HS SSD	Support	32
4XB7A93482	C0B9	ThinkSystem 2.5" U.2 CD8P 7.68TB Read Intensive NVMe PCIe 5.0 x4 HS SSD	Support	32
4XB7A93483	C0B8	ThinkSystem 2.5" U.2 CD8P 15.36TB Read Intensive NVMe PCIe 5.0 x4 HS SSD	Support	32
4XB7A93484	C0B7	ThinkSystem 2.5" U.2 CD8P 30.72TB Read Intensive NVMe PCIe 5.0 x4 HS SSD	Support	32
4XB7A93122	C0ZV	ThinkSystem 2.5" U.2 Multi Vendor 1.92TB Read Intensive NVMe PCIe 5.0 x4 HS SSD	Support	32
4XB7A93123	C0ZU	ThinkSystem 2.5" U.2 Multi Vendor 3.84TB Read Intensive NVMe PCIe 5.0 x4 HS SSD	Support	32
4XB7A93124	C0ZT	ThinkSystem 2.5" U.2 Multi Vendor 7.68TB Read Intensive NVMe PCIe 5.0 x4 HS SSD	Support	32
4XB7A93125	C0ZS	ThinkSystem 2.5" U.2 Multi Vendor 15.36TB Read Intensive NVMe PCIe 5.0 x4 HS SSD	Support	32
2.5-inch SSDs - U.3 PCIe 5.0 NVMe - Read Intensive/Entry (<3 DWPD)				
4XB7A82366	BTPZ	ThinkSystem 2.5" U.3 PM1743 1.92TB Read Intensive NVMe PCIe 5.0 x4 HS SSD	Support	32
4XB7A82367	BTQ0	ThinkSystem 2.5" U.3 PM1743 3.84TB Read Intensive NVMe PCIe 5.0 x4 HS SSD	Support	32

Part number	Feature code	Description	SED support	Max Qty
4XB7A82368	BTQ1	ThinkSystem 2.5" U.3 PM1743 7.68TB Read Intensive NVMe PCIe 5.0 x4 HS SSD	Support	32
4XB7A82369	BTQ2	ThinkSystem 2.5" U.3 PM1743 15.36TB Read Intensive NVMe PCIe 5.0 x4 HS SSD	Support	32

Table 57. 2.5-inch hot-swap PCIe 4.0 NVMe SSDs

Part number	Feature code	Description	SED support	Max Qty
2.5-inch SSDs - U.2 PCIe 4.0 NVMe - Write Intensive/Performance (10+ DWPD)				
4XB7A17158	BKKY	ThinkSystem 2.5" U.2 P5800X 400GB Write Intensive NVMe PCIe 4.0 x4 HS SSD	No	32
4XB7A17159	BKKZ	ThinkSystem 2.5" U.2 P5800X 800GB Write Intensive NVMe PCIe 4.0 x4 HS SSD	No	32
4XB7A17160	BMM8	ThinkSystem 2.5" U.2 P5800X 1.6TB Write Intensive NVMe PCIe 4.0 x4 HS SSD	No	32
2.5-inch SSDs - U.2 PCIe 4.0 NVMe - Mixed Use/Mainstream (3-5 DWPD)				
4XB7A93896	C18J	ThinkSystem 2.5" U.2 Multi Vendor 1.6TB Mixed Use NVMe PCIe 4.0 x4 HS SSD	Support	32
4XB7A93897	C18H	ThinkSystem 2.5" U.2 Multi Vendor 3.2TB Mixed Use NVMe PCIe 4.0 x4 HS SSD	Support	32
4XB7A93898	C18G	ThinkSystem 2.5" U.2 Multi Vendor 6.4TB Mixed Use NVMe PCIe 4.0 x4 HS SSD	Support	32
4XB7A93899	C18F	ThinkSystem 2.5" U.2 Multi Vendor 12.8TB Mixed Use NVMe PCIe 4.0 x4 HS SSD	Support	32
4XB7A17129	BNEG	ThinkSystem 2.5" U.2 P5620 1.6TB Mixed Use NVMe PCIe 4.0 x4 HS SSD	Support	32
4XB7A17130	BNEH	ThinkSystem 2.5" U.2 P5620 3.2TB Mixed Use NVMe PCIe 4.0 x4 HS SSD	Support	32
4XB7A17133	BNEZ	ThinkSystem 2.5" U.2 P5620 6.4TB Mixed Use NVMe PCIe 4.0 x4 HS SSD	Support	32
4XB7A17136	BA4V	ThinkSystem 2.5" U.2 P5620 12.8TB Mixed Use NVMe PCIe 4.0 x4 HS SSD	Support	32
2.5-inch SSDs - U.3 PCIe 4.0 NVMe - Mixed Use/Mainstream (3-5 DWPD)				
4XB7A95054	C2BG	ThinkSystem 2.5" U.3 7500 MAX 800GB Mixed Use NVMe PCIe 4.0 x4 HS SSD	Support	32
4XB7A95055	C2BV	ThinkSystem 2.5" U.3 7500 MAX 1.6TB Mixed Use NVMe PCIe 4.0 x4 HS SSD	Support	32
4XB7A95056	C2BW	ThinkSystem 2.5" U.3 7500 MAX 3.2TB Mixed Use NVMe PCIe 4.0 x4 HS SSD	Support	32
4XB7A95057	C2BF	ThinkSystem 2.5" U.3 7500 MAX 6.4TB Mixed Use NVMe PCIe 4.0 x4 HS SSD	Support	32
4XB7A95058	C2BX	ThinkSystem 2.5" U.3 7500 MAX 12.8TB Mixed Use NVMe PCIe 4.0 x4 HS SSD	Support	32
4XB7A79639	BNF1	ThinkSystem 2.5" U.3 7450 MAX 800GB Mixed Use NVMe PCIe 4.0 x4 HS SSD	Support	32
4XB7A13967	BNEJ	ThinkSystem 2.5" U.3 7450 MAX 1.6TB Mixed Use NVMe PCIe 4.0 x4 HS SSD	Support	32

Part number	Feature code	Description	SED support	Max Qty
4XB7A13970	BNEY	ThinkSystem 2.5" U.3 7450 MAX 3.2TB Mixed Use NVMe PCIe 4.0 x4 HS SSD	Support	32
4XB7A13971	BNEL	ThinkSystem 2.5" U.3 7450 MAX 6.4TB Mixed Use NVMe PCIe 4.0 x4 HS SSD	Support	32
4XB7A84056	BRG0	ThinkSystem 2.5" U.3 7450 MAX 12.8TB Mixed Use NVMe PCIe 4.0 x4 HS SSD	Support	32
2.5-inch SSDs - U.2 PCIe 4.0 NVMe - Read Intensive/Entry (<3 DWPD)				
4XB7A95047	C2BL	ThinkSystem 2.5" U.2 P5336 7.68TB Read Intensive NVMe PCIe 4.0 x4 HS SSD	Support	32
4XB7A95048	C2BK	ThinkSystem 2.5" U.2 P5336 15.36TB Read Intensive NVMe PCIe 4.0 x4 HS SSD	Support	32
4XB7A93075	C1WJ	ThinkSystem 2.5" U.2 P5336 30.72TB Read Intensive NVMe PCIe 4.0 x4 HS SSD	Support	32
4XB7A93076	C1WK	ThinkSystem 2.5" U.2 P5336 61.44TB Read Intensive NVMe PCIe 4.0 x4 HS SSD	Support	32
4XB7A93892	C18N	ThinkSystem 2.5" U.2 Multi Vendor 1.92TB Read Intensive NVMe PCIe 4.0 x4 HS SSD	Support	32
4XB7A93893	C18M	ThinkSystem 2.5" U.2 Multi Vendor 3.84TB Read Intensive NVMe PCIe 4.0 x4 HS SSD	Support	32
4XB7A93894	C18L	ThinkSystem 2.5" U.2 Multi Vendor 7.68TB Read Intensive NVMe PCIe 4.0 x4 HS SSD	Support	32
4XB7A93895	C18K	ThinkSystem 2.5" U.2 Multi Vendor 15.36TB Read Intensive NVMe PCIe 4.0 x4 HS SSD	Support	32
4XB7A90099	BXMB	ThinkSystem 2.5" U.2 PM9A3 960GB Read Intensive NVMe PCIe 4.0 x4 HS SSD	Support	32
4XB7A90100	BXMA	ThinkSystem 2.5" U.2 PM9A3 1.92TB Read Intensive NVMe PCIe 4.0 x4 HS SSD	Support	32
4XB7A90101	BXM9	ThinkSystem 2.5" U.2 PM9A3 3.84TB Read Intensive NVMe PCIe 4.0 x4 HS SSD	Support	32
4XB7A91776	C0G9	ThinkSystem 2.5" U.2 PM9A3 7.68TB Read Intensive NVMe PCIe 4.0 x4 HS SSD	Support	32
4XB7A13941	BMGD	ThinkSystem 2.5" U.2 P5520 1.92TB Read Intensive NVMe PCIe 4.0 x4 HS SSD	Support	32
4XB7A13942	BMGE	ThinkSystem 2.5" U.2 P5520 3.84TB Read Intensive NVMe PCIe 4.0 x4 HS SSD	Support	32
4XB7A13943	BNEF	ThinkSystem 2.5" U.2 P5520 7.68TB Read Intensive NVMe PCIe 4.0 x4 HS SSD	Support	32
4XB7A13631	BNEQ	ThinkSystem 2.5" U.2 P5520 15.36TB Read Intensive NVMe PCIe 4.0 x4 HS SSD	Support	32
2.5-inch SSDs - U.3 PCIe 4.0 NVMe - Read Intensive/Entry (<3 DWPD)				
4XB7A95049	C2BY	ThinkSystem 2.5" U.3 7500 PRO 960GB Read Intensive NVMe PCIe 4.0 x4 HS SSD	Support	32
4XB7A95050	C2BR	ThinkSystem 2.5" U.3 7500 PRO 1.92TB Read Intensive NVMe PCIe 4.0 x4 HS SSD	Support	32
4XB7A95051	C2BS	ThinkSystem 2.5" U.3 7500 PRO 3.84TB Read Intensive NVMe PCIe 4.0 x4 HS SSD	Support	32
4XB7A95052	C2BT	ThinkSystem 2.5" U.3 7500 PRO 7.68TB Read Intensive NVMe PCIe 4.0 x4 HS SSD	Support	32

Part number	Feature code	Description	SED support	Max Qty
4XB7A95053	C2BU	ThinkSystem 2.5" U.3 7500 PRO 15.36TB Read Intensive NVMe PCIe 4.0 x4 HS SSD	Support	32
4XB7A91176	BZC1	ThinkSystem 2.5" U.3 6500 ION 30.72TB Read Intensive NVMe PCIe 4.0 x4 HS SSD	Support	32
4XB7A81952	BPKY	ThinkSystem 2.5" U.3 PM1733a 3.84TB Read Intensive NVMe PCIe 4.0 x4 HS SSD	Support	32
4XB7A81953	BPKZ	ThinkSystem 2.5" U.3 PM1733a 7.68TB Read Intensive NVMe PCIe 4.0 x4 HS SSD	Support	32
4XB7A79646	BNF3	ThinkSystem 2.5" U.3 7450 PRO 960GB Read Intensive NVMe PCIe 4.0 x4 HS SSD	Support	32
4XB7A79647	BNF2	ThinkSystem 2.5" U.3 7450 PRO 1.92TB Read Intensive NVMe PCIe 4.0 x4 HS SSD	Support	32
4XB7A79648	BNF5	ThinkSystem 2.5" U.3 7450 PRO 3.84TB Read Intensive NVMe PCIe 4.0 x4 HS SSD	Support	32
4XB7A79649	BNF4	ThinkSystem 2.5" U.3 7450 PRO 7.68TB Read Intensive NVMe PCIe 4.0 x4 HS SSD	Support	32
4XB7A83097	BQAV	ThinkSystem 2.5" U.3 7450 PRO 15.36TB Read Intensive NVMe PCIe 4.0 x4 HS SSD	Support	32

Table 58. 7mm 2.5-inch hot-swap 6 Gb SATA SSDs

Part number	Feature code	Description	SED support	Max Qty
7mm 2.5-inch hot-swap SSDs - 6 Gb SATA - Read Intensive/Entry (<3 DDPD)				
4XB7A82264	BQ1U	ThinkSystem 7mm 5400 PRO 240GB Read Intensive SATA 6Gb HS SSD	Support	2
4XB7A82265	BQ1V	ThinkSystem 7mm 5400 PRO 480GB Read Intensive SATA 6Gb HS SSD	Support	2
4XB7A82266	BQ1W	ThinkSystem 7mm 5400 PRO 960GB Read Intensive SATA 6Gb HS SSD	Support	2
4XB7A82267	BR13	ThinkSystem 7mm 5400 PRO 1.92TB Read Intensive SATA 6Gb HS SSD	Support	2
4XB7A82268	BR12	ThinkSystem 7mm 5400 PRO 3.84TB Read Intensive SATA 6Gb HS SSD	Support	2
4XB7A82269	BR11	ThinkSystem 7mm 5400 PRO 7.68TB Read Intensive SATA 6Gb HS SSD	Support	2
4XB7A17106	BK79	ThinkSystem 7mm S4520 240GB Read Intensive SATA 6Gb HS SSD	No	2
4XB7A17107	BK7A	ThinkSystem 7mm S4520 480GB Read Intensive SATA 6Gb HS SSD	No	2
4XB7A17108	BK7B	ThinkSystem 7mm S4520 960GB Read Intensive SATA 6Gb HS SSD	No	2

Table 59. 7mm 2.5-inch hot-swap PCIe 4.0 NVMe SSDs

Part number	Feature code	Description	SED support	Max Qty
7mm 2.5-inch hot-swap SSDs - PCIe 4.0 NVMe - Read Intensive/Entry (<3 DWPD)				
4XB7A90096	BXMN	ThinkSystem 7mm U.2 PM9A3 960GB Read Intensive NVMe PCIe 4.0 x4 HS SSD	Support	2
4XB7A90097	BXMM	ThinkSystem 7mm U.2 PM9A3 1.92TB Read Intensive NVMe PCIe 4.0 x4 HS SSD	Support	2
4XB7A90098	BXML	ThinkSystem 7mm U.2 PM9A3 3.84TB Read Intensive NVMe PCIe 4.0 x4 HS SSD	Support	2
4XB7A82853	BPZ4	ThinkSystem 7mm U.3 7450 PRO 960GB Read Intensive NVMe PCIe 4.0 x4 HS SSD	Support	2
4XB7A82855	BPZ5	ThinkSystem 7mm U.3 7450 PRO 1.92TB Read Intensive NVMe PCIe 4.0 x4 HS SSD	Support	2
4XB7A82856	BPZ6	ThinkSystem 7mm U.3 7450 PRO 3.84TB Read Intensive NVMe PCIe 4.0 x4 HS SSD	Support	2

Table 60. 3.5-inch hot-swap 12 Gb SAS HDDs

Part number	Feature code	Description	SED support	Max Qty
3.5-inch hot-swap HDDs - 12 Gb NL SAS				
7XB7A00042	AUU5	ThinkSystem 3.5" 2TB 7.2K SAS 12Gb Hot Swap 512n HDD	No	20
7XB7A00043	AUU6	ThinkSystem 3.5" 4TB 7.2K SAS 12Gb Hot Swap 512n HDD	No	20
7XB7A00044	AUU7	ThinkSystem 3.5" 6TB 7.2K SAS 12Gb Hot Swap 512e HDD	No	20
7XB7A00045	B0YR	ThinkSystem 3.5" 8TB 7.2K SAS 12Gb Hot Swap 512e HDD	No	20
7XB7A00046	AUUG	ThinkSystem 3.5" 10TB 7.2K SAS 12Gb Hot Swap 512e HDD	No	20
7XB7A00067	B117	ThinkSystem 3.5" 12TB 7.2K SAS 12Gb Hot Swap 512e HDD	No	20
4XB7A93788	C4DA	ThinkSystem 3.5" 12TB 7.2K SAS 12Gb Hot Swap 512e HDD v2	Support	20
4XB7A13906	B496	ThinkSystem 3.5" 14TB 7.2K SAS 12Gb Hot Swap 512e HDD	No	20
4XB7A13911	B7EZ	ThinkSystem 3.5" 16TB 7.2K SAS 12Gb Hot Swap 512e HDD	No	20
4XB7A93786	C4D8	ThinkSystem 3.5" 16TB 7.2K SAS 12Gb Hot Swap 512e HDD v2	Support	20
4XB7A38266	BCFP	ThinkSystem 3.5" 18TB 7.2K SAS 12Gb Hot Swap 512e HDD	No	20
4XB7A80353	BPKU	ThinkSystem 3.5" 20TB 7.2K SAS 12Gb Hot Swap 512e HDD	No	20
4XB7A93784	C4D6	ThinkSystem 3.5" 20TB 7.2K SAS 12Gb Hot Swap 512e HDD v2	Support	20
4XB7A83766	BTR7	ThinkSystem 3.5" 22TB 7.2K SAS 12Gb Hot Swap 512e HDD	Support	20
4XB7A93007	C2BH	ThinkSystem 3.5" 24TB 7.2K SAS 12Gb Hot Swap 512e HDD	Support	20
3.5-inch hot-swap SED HDDs - 12 Gb NL SAS				
7XB7A00066	B0YQ	ThinkSystem 3.5" 8TB 7.2K SAS 12Gb Hot Swap 512e HDD FIPS	Support	20

Table 61. 3.5-inch hot-swap 6 Gb SATA HDDs

Part number	Feature code	Description	SED support	Max Qty
3.5-inch hot-swap HDDs - 6 Gb NL SATA				
7XB7A00049	AUUF	ThinkSystem 3.5" 1TB 7.2K SATA 6Gb Hot Swap 512n HDD	No	20
7XB7A00050	AUUD	ThinkSystem 3.5" 2TB 7.2K SATA 6Gb Hot Swap 512n HDD	No	20
7XB7A00051	AUU8	ThinkSystem 3.5" 4TB 7.2K SATA 6Gb Hot Swap 512n HDD	No	20
7XB7A00052	AUUA	ThinkSystem 3.5" 6TB 7.2K SATA 6Gb Hot Swap 512e HDD	No	20
7XB7A00053	AUU9	ThinkSystem 3.5" 8TB 7.2K SATA 6Gb Hot Swap 512e HDD	No	20
7XB7A00054	AUUB	ThinkSystem 3.5" 10TB 7.2K SATA 6Gb Hot Swap 512e HDD	No	20
7XB7A00068	B118	ThinkSystem 3.5" 12TB 7.2K SATA 6Gb Hot Swap 512e HDD	No	20
4XB7A93787	C4D9	ThinkSystem 3.5" 12TB 7.2K SATA 6Gb Hot Swap 512e HDD v2	Support	20
4XB7A13907	B497	ThinkSystem 3.5" 14TB 7.2K SATA 6Gb Hot Swap 512e HDD	No	20
4XB7A13914	B7F0	ThinkSystem 3.5" 16TB 7.2K SATA 6Gb Hot Swap 512e HDD	No	20
4XB7A93785	C4D7	ThinkSystem 3.5" 16TB 7.2K SATA 6Gb Hot Swap 512e HDD v2	Support	20
4XB7A38130	BCFH	ThinkSystem 3.5" 18TB 7.2K SATA 6Gb Hot Swap 512e HDD	No	20
4XB7A80354	BPKV	ThinkSystem 3.5" 20TB 7.2K SATA 6Gb Hot Swap 512e HDD	No	20
4XB7A93783	C4D5	ThinkSystem 3.5" 20TB 7.2K SATA 6Gb Hot Swap 512e HDD v2	Support	20
4XB7A83765	BTR8	ThinkSystem 3.5" 22TB 7.2K SATA 6Gb Hot Swap 512e HDD	Support	20
4XB7A93008	C2BJ	ThinkSystem 3.5" 24TB 7.2K SATA 6Gb Hot Swap 512e HDD	Support	20

Table 62. 3.5-inch hot-swap 24 Gb SAS SSDs

Part number	Feature code	Description	SED support	Max Qty
3.5-inch hot-swap SSDs - 24 Gb SAS - Mixed Use/Mainstream (3-5 DWPD)				
4XB7A80344	BNW7	ThinkSystem 3.5" PM1655 800GB Mixed Use SAS 24Gb HS SSD	Support	20
4XB7A80345	BNWA	ThinkSystem 3.5" PM1655 1.6TB Mixed Use SAS 24Gb HS SSD	Support	20
4XB7A80346	BNWB	ThinkSystem 3.5" PM1655 3.2TB Mixed Use SAS 24Gb HS SSD	Support	20
4XB7A80347	BP3G	ThinkSystem 3.5" PM1655 6.4TB Mixed Use SAS 24Gb HS SSD	Support	20
3.5-inch hot-swap SSDs - 24 Gb SAS - Read Intensive/Entry/Capacity (<3 DWPD)				
4XB7A80324	BNWD	ThinkSystem 3.5" PM1653 960GB Read Intensive SAS 24Gb HS SSD	Support	20
4XB7A80325	BNWG	ThinkSystem 3.5" PM1653 1.92TB Read Intensive SAS 24Gb HS SSD	Support	20
4XB7A80326	BNWH	ThinkSystem 3.5" PM1653 3.84TB Read Intensive SAS 24Gb HS SSD	Support	20
4XB7A80327	BP3F	ThinkSystem 3.5" PM1653 7.68TB Read Intensive SAS 24Gb HS SSD	Support	20
4XB7A80328	BP3H	ThinkSystem 3.5" PM1653 15.36TB Read Intensive SAS 24Gb HS SSD	Support	20

Table 63. 3.5-inch hot-swap 12 Gb SAS SSDs

Part number	Feature code	Description	SED support	Max Qty
3.5-inch hot-swap SSDs - 12 Gb SAS - Write Intensive/Performance (10+ DWPD)				
4XB7A83219	BR0V	ThinkSystem 3.5" Nytro 3750 800GB Write Intensive SAS 12Gb HS SSD	Support	20
4XB7A83220	BR0U	ThinkSystem 3.5" Nytro 3750 1.6TB Write Intensive SAS 12Gb HS SSD	Support	20
4XB7A83221	BR0T	ThinkSystem 3.5" Nytro 3750 3.2TB Write Intensive SAS 12Gb HS SSD	Support	20
4XB7A70011	BG03	ThinkSystem 3.5" Nytro 3732 400GB Performance SAS 12Gb Hot Swap SSD	No	20

Table 64. 3.5-inch hot-swap 6 Gb SATA SSDs

Part number	Feature code	Description	SED support	Max Qty
3.5-inch hot-swap SSDs - 6 Gb SATA - Mixed Use/Mainstream (3-5 DWPD)				
4XB7A90888	BYM3	ThinkSystem 3.5" Multi Vendor 480GB Mixed Use SATA 6Gb HS SSD v2	No	20
4XB7A90889	BYM7	ThinkSystem 3.5" Multi Vendor 960GB Mixed Use SATA 6Gb HS SSD v2	No	20
4XB7A90890	BYM8	ThinkSystem 3.5" Multi Vendor 1.92TB Mixed Use SATA 6Gb HS SSD v2	No	20
4XB7A90891	BYLX	ThinkSystem 3.5" Multi Vendor 3.84TB Mixed Use SATA 6Gb HS SSD v2	No	20
4XB7A17137	BA4W	ThinkSystem 3.5" S4620 480GB Mixed Use SATA 6Gb HS SSD	No	20
4XB7A17138	BA4X	ThinkSystem 3.5" S4620 960GB Mixed Use SATA 6Gb HS SSD	No	20
4XB7A17139	BA4Y	ThinkSystem 3.5" S4620 1.92TB Mixed Use SATA 6Gb HS SSD	No	20
4XB7A17140	BK7P	ThinkSystem 3.5" S4620 3.84TB Mixed Use SATA 6Gb HS SSD	No	20
3.5-inch hot-swap SSDs - 6 Gb SATA - Read Intensive/Entry (<3 DWPD)				
4XB7A90878	BYLW	ThinkSystem 3.5" Multi Vendor 240GB Read Intensive SATA 6Gb HS SSD v2	No	20
4XB7A90879	BYLJ	ThinkSystem 3.5" Multi Vendor 480GB Read Intensive SATA 6Gb HS SSD v2	No	20
4XB7A90880	BYLY	ThinkSystem 3.5" Multi Vendor 960GB Read Intensive SATA 6Gb HS SSD v2	No	20
4XB7A90881	BYLZ	ThinkSystem 3.5" Multi Vendor 1.92TB Read Intensive SATA 6Gb HS SSD v2	No	20
4XB7A90882	BYM0	ThinkSystem 3.5" Multi Vendor 3.84TB Read Intensive SATA 6Gb HS SSD v2	No	20
4XB7A90883	BYM1	ThinkSystem 3.5" Multi Vendor 7.68TB Read Intensive SATA 6Gb HS SSD v2	No	20
4XB7A17118	BA7K	ThinkSystem 3.5" S4520 240GB Read Intensive SATA 6Gb HS SSD	No	20
4XB7A17119	BA7L	ThinkSystem 3.5" S4520 480GB Read Intensive SATA 6Gb HS SSD	No	20
4XB7A17120	BA7M	ThinkSystem 3.5" S4520 960GB Read Intensive SATA 6Gb HS SSD	No	20
4XB7A17121	BA7N	ThinkSystem 3.5" S4520 1.92TB Read Intensive SATA 6Gb HS SSD	No	20
4XB7A17122	BK7F	ThinkSystem 3.5" S4520 3.84TB Read Intensive SATA 6Gb HS SSD	No	20
4XB7A17123	BK7G	ThinkSystem 3.5" S4520 7.68TB Read Intensive SATA 6Gb HS SSD	No	20

Table 65. 3.5-inch hot-swap PCIe 4.0 NVMe SSDs

Part number	Feature code	Description	SED support	Max Qty
3.5-inch SSDs - U.2 PCIe 4.0 NVMe - Write Intensive/Performance (10+ DWPD)				
4XB7A17161	BMM7	ThinkSystem 3.5" U.2 P5800X 400GB Write Intensive NVMe PCIe 4.0 x4 HS SSD	No	12
4XB7A17162	BMM5	ThinkSystem 3.5" U.2 P5800X 800GB Write Intensive NVMe PCIe 4.0 x4 HS SSD	No	12
4XB7A77070	BMM6	ThinkSystem 3.5" U.2 P5800X 1.6TB Write Intensive NVMe PCIe 4.0 x4 HS SSD	No	12
3.5-inch SSDs - U.2 PCIe 4.0 NVMe - Mixed Use/Mainstream (3-5 DWPD)				
4XB7A17141	BNEK	ThinkSystem 3.5" U.2 P5620 1.6TB Mixed Use NVMe PCIe 4.0 x4 HS SSD	Support	12
4XB7A17143	BNEM	ThinkSystem 3.5" U.2 P5620 3.2TB Mixed Use NVMe PCIe 4.0 x4 HS SSD	Support	12
4XB7A17144	BNEN	ThinkSystem 3.5" U.2 P5620 6.4TB Mixed Use NVMe PCIe 4.0 x4 HS SSD	Support	12
4XB7A17148	BNEP	ThinkSystem 3.5" U.2 P5620 12.8TB Mixed Use NVMe PCIe 4.0 x4 HS SSD	Support	12
3.5-inch SSDs - U.2 PCIe 4.0 NVMe - Read Intensive/Entry (<3 DWPD)				
4XB7A13632	BNES	ThinkSystem 3.5" U.2 P5520 1.92TB Read Intensive NVMe PCIe 4.0 x4 HS SSD	Support	12
4XB7A76777	BNET	ThinkSystem 3.5" U.2 P5520 3.84TB Read Intensive NVMe PCIe 4.0 x4 HS SSD	Support	12
4XB7A76778	BNEU	ThinkSystem 3.5" U.2 P5520 7.68TB Read Intensive NVMe PCIe 4.0 x4 HS SSD	Support	12
4XB7A76779	BNF0	ThinkSystem 3.5" U.2 P5520 15.36TB Read Intensive NVMe PCIe 4.0 x4 HS SSD	Support	12

Table 66. M.2 SATA drives

Part number	Feature code	Description	SED support	Max Qty
M.2 SSDs - 6 Gb SATA - Read Intensive/Entry (<3 DWPD)				
4XB7A89422	BYF7	ThinkSystem M.2 ER3 240GB Read Intensive SATA 6Gb NHS SSD	Support	2
4XB7A90049	BYF8	ThinkSystem M.2 ER3 480GB Read Intensive SATA 6Gb NHS SSD	Support	2
4XB7A90230	BYF9	ThinkSystem M.2 ER3 960GB Read Intensive SATA 6Gb NHS SSD	Support	2
4XB7A82286	BQ1Z	ThinkSystem M.2 5400 PRO 240GB Read Intensive SATA 6Gb NHS SSD	Support	2
4XB7A82287	BQ1Y	ThinkSystem M.2 5400 PRO 480GB Read Intensive SATA 6Gb NHS SSD	Support	2
4XB7A82288	BQ20	ThinkSystem M.2 5400 PRO 960GB Read Intensive SATA 6Gb NHS SSD	Support	2
7N47A00130	AUUV	ThinkSystem M.2 128GB SATA 6Gbps Non-Hot Swap SSD	No	2

Table 67. M.2 PCIe 4.0 NVMe drives

Part number	Feature code	Description	SED support	Max Qty
M.2 SSDs - PCIe 4.0 NVMe - Read Intensive/Entry (<3 DWPD)				
4XB7A90102	BXMH	ThinkSystem M.2 PM9A3 960GB Read Intensive NVMe PCIe 4.0 x4 NHS SSD	Support	2
4XB7A82636	BS2P	ThinkSystem M.2 7450 PRO 480GB Read Intensive NVMe PCIe 4.0 x4 NHS SSD	Support	2
4XB7A13999	BKSR	ThinkSystem M.2 7450 PRO 960GB Read Intensive NVMe PCIe 4.0 x4 NHS SSD	Support	2

USB flash drive

For general portable storage needs, the server also supports the USB flash drive option that is listed in the following table.

Table 68. USB memory key

Part number	Feature	Description
4X77A77065	BNWN	ThinkSystem USB 32GB USB 3.0 Flash Drive

Internal backup units

The server does not support any internal backup units, such as tape drives or RDX drives. External backup units are available as described in the [External backup units](#) section.

Optical drives

The server supports the external USB optical drive listed in the following table.

Table 69. External optical drive

Part number	Feature code	Description
7XA7A05926	AVV8	ThinkSystem External USB DVD RW Optical Disk Drive

The drive is based on the Lenovo Slim DVD Burner DB65 drive and supports the following formats: DVD-RAM, DVD-RW, DVD+RW, DVD+R, DVD-R, DVD-ROM, DVD-R DL, CD-RW, CD-R, CD-ROM.

I/O expansion

The SR650 V3 supports a total of up to 12x PCIe slots, 10x at the rear and 2x at the front, plus 1x OCP 3.0 SFF slot for networking. The OCP slot can be either at the front or at the rear (but not both). Slot availability is based on riser selection and drive bays configured. The use of some slots requires that both processors be installed as listed below.

Topics in this section:

- [Slot layout and connections](#)
- [Ordering information](#)
- [Serial port](#)
- [Slot field upgrades](#)

Slot layout and connections

The rear slots are provided by riser cards:

- Riser 1: Slots 1, 2 and 3, all full-height slots (connect to CPU 1)
- Riser 2: Slots 4, 5, and 6, all full-height slots (connect to CPU 2)
- Riser 3: Slot 7 and 8
 - When configured as Riser 3 only, where slots 7 and 8 are full-height slots:
 - Slot 7 connects to CPU 1
 - Slot 8 connects to CPU 2 (for a 2-socket server) or to CPU 1 (for a 1-socket server)
 - When configured as Riser 3+Riser 4, where slots 7 and 8 are low-profile slots:
 - Both slots connect to CPU 1
- Riser 4: Slots 9 and 10, both low-profile slots (connect to CPU 2)

The rear of the server also contains an OCP 3.0 slot, numbered as Slot 13 (connects to CPU 1).

NVMe support: Riser 3 can be configured together with up to 8x NVMe or AnyBay drive bays.

The slots in each riser are either PCIe x16 or PCIe x8 depending on the riser card selected as listed in the table below. All x8 slots are open-ended and physically support x16 adapters. Depending on the risers selected, slots are either PCIe 5.0 or PCIe 4.0. The OCP slot has a PCIe 5.0 x16 host interface when located at the rear of the server or PCIe 4.0 x16 when located at the front of the server.

The SR650 V3 also supports front-accessible PCIe slots: 2x PCIe 4.0 x16 slots plus a dedicated OCP 3.0 SFF slot with PCIe 4.0 interface for networking. Front-accessible slots are as follows:

- Slot 11: PCIe 4.0 x16 FHHL (connects to CPU 2)
- Slot 12: PCIe 4.0 x16 FHHL (connects to CPU 1)
- Front OCP slot (slot 14): PCIe 4.0 x16 (connects to CPU 1)

As discussed in the [Internal storage](#) section, the server supports drive bays in the rear of the server. Depending on the drive bays selected, the number of slots available for adapters is reduced. The figure below shows the supported combinations of slots and drive bays.

Internal HBA/RAID adapter: For configurations with 2.5-inch front drive bays, an internal RAID adapter or HBA can be installed in a dedicated space and cabled to a PCIe x8 connector, thereby freeing up a slot for other purposes.

The following figure shows the locations of the rear-accessible slots for each configuration selection. The OCP slot is located in the lower-left corner.

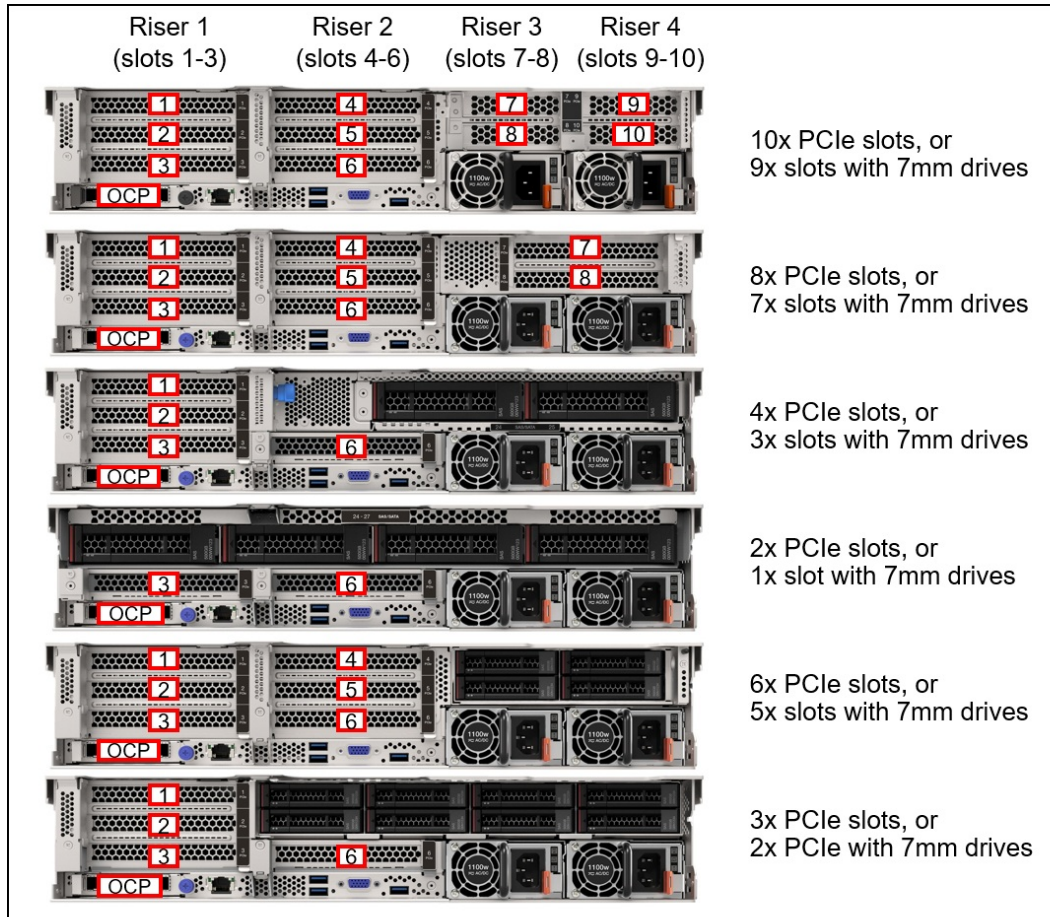

Figure 17. SR650 V3 rear slot configurations

The following figure shows the locations of the front-accessible slots.

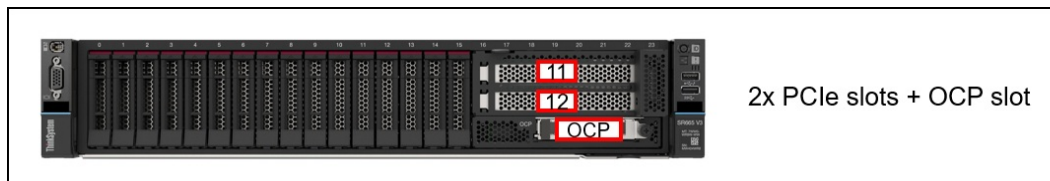

Figure 18. SR650 V3 front slots

Ordering information

The following table lists the riser cards available for CTO builds and for field upgrades.

No slots: It is also possible to build a configuration without any slots, in which case slot fillers will be derived in the configurator. Slots can be added later as field upgrades using option part numbers as listed in the table.

Table 70. Riser cards

Part number	Feature code	Description	Slot configuration* (Green = Gen5, Blue = Gen4)			Purpose
			Slot 1	Slot 2	Slot 3	
Rear Riser 1 (FH slots)						

Part number	Feature code	Description	Slot configuration* (Green = Gen5, Blue = Gen4)				Purpose
			Slot 1	Slot 2	Slot 3	Slot 4	
4XH7A91474	BYPY	ThinkSystem SR650 V3 x16/x8/x8 PCIe Gen5 Riser1 or 2 v2	Gen5 x16	Gen5 x8	Gen5 x8		3 slots PCIe 5.0
4XH7A82898	BPQU	ThinkSystem V3 2U x16/x8/x8 PCIe Gen5 Riser 1 or 2	Gen5 x16	Gen5 x8	Gen5 x8		3 slots PCIe 5.0
4XH7A82896	BLKL	ThinkSystem V3 2U x16/x8/x8 PCIe Gen4 Riser1 or 2	Gen4 x16	Gen4 x8	Gen4 x8		3 slots PCIe 4.0
4XH7A91475	BYPZ	ThinkSystem SR650 V3 x16/x16/E PCIe Gen5 Riser1 or 2 v2	Gen5 x16	Gen5 x16	No slot		2 slots PCIe 5.0; COM port or 7mm drives in slot 3
4XH7A82900	BPQV	ThinkSystem V3 2U x16/x16/E PCIe Gen5 Riser1 or 2	Gen5 x16	Gen5 x16	No slot		2 slots PCIe 5.0; COM port or 7mm drives in slot 3
4XH7A82892	BLKM	ThinkSystem V3 2U x16/x16/E PCIe Gen4 Riser1 or 2	Gen4 x16	Gen4 x16	No slot		2 slots PCIe 4.0; COM port or 7mm drives in slot 3
4XH7A91476	BYQ0	ThinkSystem SR650 V3 E/x16/x16 PCIe Gen5 Riser1 or 2 v2	No slot	Gen5 x16	Gen5 x16		2 slots PCIe 5.0; DW GPU in slot 2
4XH7A82902	BPQW	ThinkSystem V3 2U E/x16/x16 PCIe Gen5 Riser1 or 2	No slot	Gen5 x16	Gen4 x16		PCIe 5.0 in slot 2; DW GPU in slot 2
4XH7A82894	BLKN	ThinkSystem V3 2U G4 E/x16/x16 PCIe Riser1 or 2	No slot	Gen4 x16	Gen4 x16		2 slots PCIe 4.0; DW GPU in slot 2
4XH7A82890	BLKP	ThinkSystem V3 2U x16 PCIe Gen4 Riser1 or 2	No slot	No slot	Gen4 x16		1 slot PCIe 4.0; For 4x 3.5-inch rear drives
Rear Riser 2 (FH slots)			Slot 4	Slot 5	Slot 6		
4XH7A82898	BPQU	ThinkSystem V3 2U x16/x8/x8 PCIe Gen5 Riser 1 or 2	Gen5 x16	Gen5 x8	Gen5 x8		3 slots PCIe 5.0
4XH7A82896	BLKL	ThinkSystem V3 2U x16/x8/x8 PCIe Gen4 Riser1 or 2	Gen4 x16	Gen4 x8	Gen4 x8		3 slots PCIe 4.0
4XH7A82900	BPQV	ThinkSystem V3 2U x16/x16/E PCIe Gen5 Riser1 or 2	Gen5 x16	Gen5 x16	No slot		2 slots PCIe 5.0; COM port or 7mm drives in slot 6
4XH7A82892	BLKM	ThinkSystem V3 2U x16/x16/E PCIe Gen4 Riser1 or 2	Gen4 x16	Gen4 x16	No slot		2 slots PCIe 4.0; COM port or 7mm drives in slot 6
4XH7A82902	BPQW	ThinkSystem V3 2U E/x16/x16 PCIe Gen5 Riser1 or 2	No slot	Gen5 x16	Gen4 x16		PCIe 5.0 in slot 5; DW GPU in slot 5
4XH7A82894	BLKN	ThinkSystem V3 2U G4 E/x16/x16 PCIe Riser1 or 2	No slot	Gen4 x16	Gen4 x16		2 slots PCIe 4.0; DW GPU in slot 5

Part number	Feature code	Description	Slot configuration* (Green = Gen5, Blue = Gen4)				Purpose
			Slot 7	Slot 8	Slot 9	Slot 10	
4XH7A82890	BLKP	ThinkSystem V3 2U x16 PCIe Gen4 Riser1 or 2	No slot	No slot	Gen4 x16		1 slot PCIe 4.0; For 2x or 4x 3.5-inch rear drives
Rear Riser 3 (2x FH slots)			Slot 7	Slot 8			
4XH7A82907	BLL9	ThinkSystem V3 2U x16/x16 PCIe Gen5 Riser3 Kit	Gen5 x16	Gen5 x16			2x PCIe 5.0 x16 slots; DW GPU in slot 7 (use of both slots requires 2 CPUs)
4XH7A82905	BPKG	ThinkSystem V3 2U x16/x16 PCIe Gen4 Riser3 Kit with Cage	Gen4 x16	Gen4 x16			2x PCIe 4.0 x16 slots; DW GPU in slot 7 (use of both slots requires 2 CPUs)
4XH7A82906	BPKH	ThinkSystem V3 2U x8/x8 PCIe Gen5 Riser3 Kit with Cage	Gen5 x8	Gen5 x8			2x PCIe 5.0 x8 slots
4XH7A82904	BPKF	ThinkSystem V3 2U x8/x8 PCIe Gen4 Riser3 Kit with Cage	Gen4 x8	Gen4 x8			2x PCIe 4.0 x8 slots
Rear Riser 3 & 4 (4x LP slots)			Slot 7	Slot 8	Slot 9	Slot 10	
4XH7A86662	BQ2W†	ThinkSystem V3 2U PCIe Gen5 Riser 3/4-part 1 for Rear 10 slots	Gen5 x8	Gen5 x8			2x PCIe 5.0 x8 slots
	BTMS†	ThinkSystem V3 2U PCIe Gen5 Riser 3/4-part 2 for Rear 10 slots			Gen5 x8	Gen4 x8	2x PCIe x8 slots (Gen 5, Gen4)
Front Riser			Slot 11	Slot 12			
CTO only	BQ2X	ThinkSystem V3 2U Front x16/x16 PCIe G4 Riser	Gen4 x16	Gen4 x16			2x PCIe 4.0 x16 front- accessible slots

* All PCIe x8 slots are open ended and will physically support x16 adapters

† In the configurator, when feature BQ2W is selected, BTMS is automatically derived and provides slots 9 & 10. 4XH7A86662 contains both risers. (Note: see the configuration rule below regarding the front drive bay support for 10x rear slots)

Configuration rules:

- For best performance, install PCIe 5.0 adapters in PCIe 5.0 (Gen5) slots
- The server only supports one OCP slot, either in the rear of the server or the front of the server, not both
- The use of Riser 3 is mutually exclusive to onboard NVMe support as they use the same PCIe connectors.
- Only the following drive bay configurations at the front of the server support the use of 10x rear slots (risers 1, 2, 3 and 4). These correspond to storage configs 9, 12, 14, 41, 31, 33, 35, 39, 40. All other configurations may require special bid support.
 - 8x 2.5-inch SAS/SATA
 - 8x 2.5-inch AnyBay
 - 16x 2.5-inch SAS/SATA
 - 16x 2.5-inch AnyBay
- If you configure Riser 3 using a x16/x16 FH riser (feature BLL9 or BPKG) with only 1 processor installed,

Slot 7 will be connected with x16 lanes, however Slot 8 will not be connected. If you later install the second processor as a field upgrade, you will need to order the necessary cable kit (4X97A82946 or 4X97A82944) to enable Slot 8. See [Slot field upgrades](#) for information.

- With only 1 processor installed, Riser 3 can only be enabled using using a x8/x8 FH riser (feature BPKH or BPKF)
- If you want to configure 4x low profile slots for slots 7-10, select feature BQ2W which provides riser 3 (slots 7, 8). Feature BTMS will then be automatically derived to provide riser 4 (slots 9 & 10), along with the necessary cables. Option part number 4XH7A86662 contains both of these risers and the cables.
- The following vRAN processors have fewer PCIe lanes (see the [Processor features](#) section) and therefore do not support Riser 3. They are also 1-socket processors, so they also don't support Riser 2. Only Riser 1 and the OCP slot are supported.
 - Intel Xeon Gold 5423N 20C 145W 2.1GHz Processor
 - Intel Xeon Gold 5433N 20C 160W 2.3GHz Processor
 - Intel Xeon Gold 6403N 24C 185W 1.9GHz Processor
 - Intel Xeon Gold 6423N 28C 195W 2.0GHz Processor
 - Intel Xeon Gold 6433N 32C 205W 2.0GHz Processor
 - Intel Xeon Gold 6443N 32C 195W 1.6GHz Processor
- If you want to add both a 7mm drive enclosure plus 2x PCIe slots above it, you will need to order the 7mm drive option (either 4XH7A85898 or 4XH7A85899) plus the x16/x16/E riser kit (4XH7A82900 for PCIe Gen 5 or 4XH7A82892 for Gen 4). The riser kit part number provides the 2-slot riser card.
- All PCIe x8 slots are open ended and will physically support x16 adapters

Serial port

The SR650 V3 optionally supports a RS-232 serial port by adding a COM port bracket to either slot 3 or slot 6. Ordering information is shown in the following table.

Front PCIe slots: The serial port is not supported in the front PCIe slots

Table 71. Serial port

Part number	Feature code	Description	Max quantity	Slots supported
4X97A82921	BMNJ	ThinkSystem V2/V3 1U COM Port Upgrade Kit	1	3, 6

Configuration rules:

- If double-wide GPUs are installed, the serial port is only supported in slot 6 due to a cable length limitation.

The bracket is shown in the following figure. The option part number includes both Low Profile and Full Height brackets.

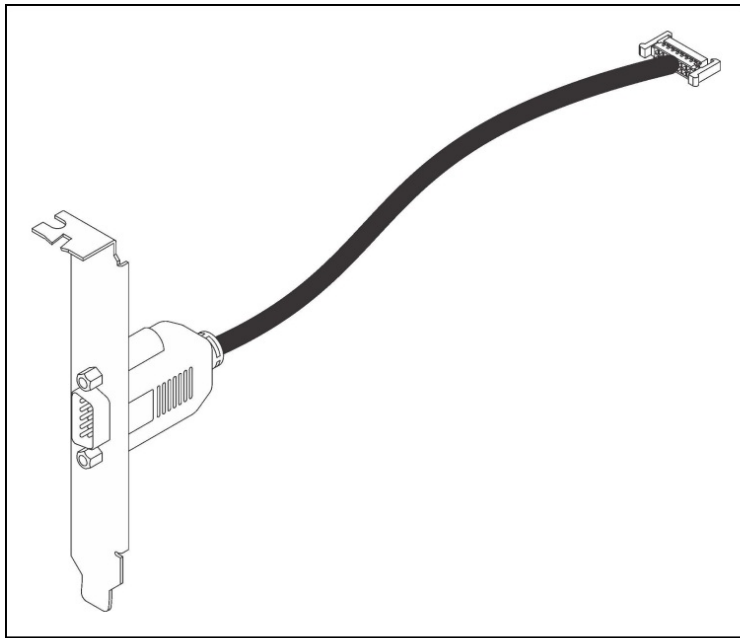

Figure 19. ThinkSystem COM Port Upgrade Kit v2

Slot field upgrades

Slot configurations can also be ordered as field upgrades using option part numbers, as listed in the following table.

Table 72. Slot field upgrades

Part number	Description
Riser 1 and Riser 2 field upgrades - PCIe Gen5	
4XH7A82898	ThinkSystem V3 2U x16/x8/x8 PCIe Gen5 Riser 1/2 Option Kit
4XH7A82900	ThinkSystem V3 2U x16/x16/E PCIe Gen5 Riser 1/2 Option Kit
4XH7A82902	ThinkSystem V3 2U E/x16/x16 PCIe Gen5 Riser 1/2 Option Kit
Riser 1 and Riser 2 field upgrades - PCIe Gen4	
4XH7A82896	ThinkSystem V3 2U x16/x8/x8 PCIe Gen4 Riser 1/2 Option Kit
4XH7A82892	ThinkSystem V3 2U x16/x16/E PCIe Gen4 Riser 1/2 Option Kit
4XH7A82894	ThinkSystem V3 2U E/x16/x16 PCIe Gen4 Riser 1/2 Option Kit
4XH7A82890	ThinkSystem V3 2U x16 PCIe Gen4 Riser 1/2 Option Kit
Riser 3 and 4 field upgrades - PCIe Gen5	
4XH7A82906	ThinkSystem SR650 V3 x8/x8 PCIe Gen5 Riser3 Option Kit (To support Riser 3 when 2 processors are installed)
4XH7A82907	ThinkSystem SR650 V3 x16/x16 PCIe Gen5 Riser3 Option Kit
4XH7A86662	ThinkSystem V3 2U PCIe Gen5 Riser 3/4-part 2 for Rear 10 slots
4XH7A87512	ThinkSystem Single Processor SR650 V3 x8/x8 PCIe Gen5 Riser3 Kit (To support Riser 3 when only 1 processor is installed)
4X97A82946	ThinkSystem 2nd Processor Upgrade SR650 V3 PCIe Gen5 Riser3 Cable Kit (For use when adding a second processor to the server, to enable all Riser 3 slots; replaces existing Riser 3 cabling)
Riser 3 and 4 field upgrades - PCIe Gen4	
4XH7A82904	ThinkSystem SR650 V3 x8/x8 PCIe Gen4 Riser3 Option Kit (To support Riser 3 when 2 processors are installed)
4XH7A82905	ThinkSystem SR650 V3 x16/x16 PCIe Gen4 Riser3 Option Kit
4XH7A87511	ThinkSystem Single Processor SR650 V3 x8/x8 PCIe Gen4 Riser3 Kit (To support Riser 3 when only 1 processor is installed)
4X97A82944	ThinkSystem 2nd Processor Upgrade SR650 V3 PCIe Gen4 Riser3 Cable Kit (For use when adding a second processor to the server, to enable all Riser 3 slots; replaces existing Riser 3 cabling)

Network adapters

The server has a dedicated OCP 3.0 SFF slot with a PCIe x16 host interface. See [Figure 3](#) for the location of the OCP slot. When located at the rear of the server, the OCP slot operates at PCIe 5.0 speed (once PCIe 5.0 OCP adapters are supported); when located at the front of the server, the OCP slot operates at PCIe 4.0 speed.

The following table lists the supported OCP adapters. One port can optionally be shared with the XCC management processor for Wake-on-LAN and NC-SI support. Only 1 OCP card can be installed in the server, either rear-accessible or front-accessible.

Table 73. Supported OCP adapters

Part number	Feature code	Description	Maximum supported	Windows 10/11 support
Gigabit Ethernet				
4XC7A08235	B5T1	ThinkSystem Broadcom 5719 1GbE RJ45 4-port OCP Ethernet Adapter	1	Supported
4XC7A88428	BW97	ThinkSystem Intel I350 1GbE RJ45 4-Port OCP Ethernet Adapter V2	1	Supported
4XC7A08277	B93E	ThinkSystem Intel I350 1GbE RJ45 4-port OCP Ethernet Adapter	1	Supported
10 Gb Ethernet - 10GBASE-T				
4XC7A08236	B5ST	ThinkSystem Broadcom 57416 10GBASE-T 2-port OCP Ethernet Adapter	1	Supported
4XC7A08240	B5T4	ThinkSystem Broadcom 57454 10GBASE-T 4-port OCP Ethernet Adapter	1	Supported
4XC7A08278	BCD5	ThinkSystem Intel X710-T2L 10GBASE-T 2-port OCP Ethernet Adapter	1	Supported
4XC7A80268	BPPY	ThinkSystem Intel X710-T4L 10GBase-T 4-Port OCP Ethernet Adapter	1	Supported
25 Gb Ethernet				
4XC7A08237	BN2T	ThinkSystem Broadcom 57414 10/25GbE SFP28 2-Port OCP Ethernet Adapter	1	Supported
4XC7A80567	BPPW	ThinkSystem Broadcom 57504 10/25GbE SFP28 4-Port OCP Ethernet Adapter	1	Supported
4XC7A08294	BCD4	ThinkSystem Intel E810-DA2 10/25GbE SFP28 2-Port OCP Ethernet Adapter	1	Supported
4XC7A80269	BP8L	ThinkSystem Intel E810-DA4 10/25GbE SFP28 4-Port OCP Ethernet Adapter	1	Supported
4XC7A62582	BE4T	ThinkSystem Mellanox ConnectX-6 Lx 10/25GbE SFP28 2-Port OCP Ethernet Adapter	1	Supported
100 Gb Ethernet				
4XC7A08243	BPPX	ThinkSystem Broadcom 57508 100GbE QSFP56 2-Port OCP Ethernet Adapter	1	Supported

The following table lists additional supported network adapters that can be installed in the regular PCIe slots.

Table 74. Supported PCIe Network Adapters

Part number	Feature	Description	Max Qty	Slots supported	PCIe lanes	Windows 10/11 support
Gigabit Ethernet						
7ZT7A00484	AUZV	ThinkSystem Broadcom 5719 1GbE RJ45 4-Port PCIe Ethernet Adapter	12	1 - 12	x8	Supported
7ZT7A00535	AUZW	ThinkSystem I350-T4 PCIe 1Gb 4-Port RJ45 Ethernet Adapter	12	1 - 12	x4	Supported
10 Gb Ethernet - 10GBASE-T						
7ZT7A00496	AUKP	ThinkSystem Broadcom 57416 10GBASE-T 2-Port PCIe Ethernet Adapter	12	1 - 12	x8	Supported

Part number	Feature	Description	Max Qty	Slots supported	PCIe lanes	Windows 10/11 support
4XC7A08245	B5SU	ThinkSystem Broadcom 57454 10GBASE-T 4-port PCIe Ethernet Adapter	12	1 - 12	x8	Supported
4XC7A80266	BNWL	ThinkSystem Intel X710-T2L 10GBase-T 2-Port PCIe Ethernet Adapter	12	1 - 12	x8	Supported
4XC7A79699	BMXB	ThinkSystem Intel X710-T4L 10GBase-T 4-Port PCIe Ethernet Adapter	12	1 - 12	x8	Supported
25 Gb Ethernet						
4XC7A84827	BUQK	ThinkSystem AMD X3522 10/25GbE DSFP28 2-Port PCIe Ethernet Adapter (Low Latency)	6	1 - 6	x8	No
4XC7A08238	BK1H	ThinkSystem Broadcom 57414 10/25GbE SFP28 2-port PCIe Ethernet Adapter	12	1 - 12	x8	Supported
4XC7A80566	BNWM	ThinkSystem Broadcom 57504 10/25GbE SFP28 4-Port PCIe Ethernet Adapter	6	1-8,11,12	x16	Supported
4XC7A08295	BCD6	ThinkSystem Intel E810-DA2 10/25GbE SFP28 2-Port PCIe Ethernet Adapter	12	1 - 12	x8	Supported
4XC7A80267	BP8M	ThinkSystem Intel E810-DA4 10/25GbE SFP28 4-Port PCIe Ethernet Adapter	10	1-8,11,12	x16	Supported
4XC7A62580	BE4U	ThinkSystem Mellanox ConnectX-6 Lx 10/25GbE SFP28 2-Port PCIe Ethernet Adapter	12	1 - 12	x8	Supported
4XC7A62581	BHE2	ThinkSystem Solarflare X2522-Plus 10/25GbE SFP28 2-Port PCIe Ethernet Adapter	12	1 - 12	x8	Supported
100 Gb Ethernet / InfiniBand HDR						
4XC7A08297	BK1J	ThinkSystem Broadcom 57508 100GbE QSFP56 2-Port PCIe 4 Ethernet Adapter	6	1-8,11,12	x16	Supported
4XC7A08248	B8PP	ThinkSystem Mellanox ConnectX-6 Dx 100GbE QSFP56 2-port PCIe Ethernet Adapter	6	1-8,11,12	x16	Supported
4C57A14177	B4R9	ThinkSystem Mellanox ConnectX-6 HDR100/100GbE QSFP56 1-port PCIe VPI Adapter	6	1-8,11,12	x16	No
4C57A14178	B4RA	ThinkSystem Mellanox ConnectX-6 HDR100/100GbE QSFP56 2-port PCIe VPI Adapter	6	1-8,11,12	x16	No
200 Gb Ethernet / InfiniBand HDR/NDR200						
4C57A15326	B4RC	ThinkSystem Mellanox ConnectX-6 HDR/200GbE QSFP56 1-port PCIe 4 VPI Adapter	6	1-8,11,12	x16	No
4XC7A81883	BQBN	ThinkSystem NVIDIA ConnectX-7 NDR200/200GbE QSFP112 2-port PCIe Gen5 x16 Adapter	6	1-8,11,12	x16	No
4C57A14179	B4RB	ThinkSystem Mellanox HDR/200GbE 2x PCIe Aux Kit	3	4,5,8	x16	No
400Gb / NDR InfiniBand						
4XC7A80289	BQ1N	ThinkSystem NVIDIA ConnectX-7 NDR OSFP400 1-Port PCIe Gen5 x16 InfiniBand Adapter	6	1-8,11,12	x16	No

For more information, including the transceivers and cables that each adapter supports, see the list of Lenovo Press Product Guides in the Networking adapters category:

<https://lenovopress.com/servers/options/ethernet>

Configuration requirements:

- Adapters with a x16 host interface require a x16 slot to maximize performance
- PCIe Gen5 adapters will require a Gen5 riser to maximize performance

- **E810 Ethernet and X350 RAID/HBAs:** The use of both an Intel E810 network adapter and an X350 HBA/RAID adapter (9350, 5350 and 4350) is supported, however E810 firmware CVL4.3 or later is required. For details, see [Support Tip HT513226](#).

DPU adapters

The SR650 V3 supports DPUs for VMware Cloud Foundation using the NVIDIA BlueField-2 Data Processing Unit (DPU). This solution provides zero-trust security and accelerate workloads by improving performance with increased throughput and lower latency by offloading NSX Firewall rules applied at the DPU compute layer thereby making data center applications more efficient.

In addition to these key features, the SR650 V3 now supports up to 2x NVIDIA BlueField-2 Data Processing Units (DPUs) that provides:

- High Availability and Redundancy - Customers can configure the DPUs in an Active-Standby state to enhance redundancy. In this mode, if the active DPU fails, all traffic seamlessly fails over to the standby DPU, ensuring that there is no disruption in service. This configuration is perfect for mission-critical applications where uptime is paramount.
- Enhanced Performance - Both DPUs operate independently, providing maximum throughput. This configuration is ideal for environments where performance is critical, as it takes full advantage of the increased bandwidth with twice the capacity.

Support for DPUs is available in CTO builds using the following DPU-specific models:

- 7D76CTO4WW and 7D76CTOGWW (3-year warranty)
- 7D75CTO4WW (1-year warranty)

The DSE solution comprises of two primary components:

- NVIDIA BlueField-2 full-height half-length (FHHL) PCIe adapter (feature BRPK)
- OCP adapter to provide the necessary NC-SI connectivity to the XCC management processor of the server (feature BSH7)

The NVIDIA Bluefield-2 DPU has 8x ARM processor cores, 32GB onboard DDR4 ECC memory, and 2x 25GbE SFP56 ports. The purpose-built hardware-acceleration engines, embedded crypto and secure boot capabilities, and a software stack powered by the NVIDIA DOCA framework provide breakthrough data center performance, efficiency and security for software-defined storage, networking, and management of workloads.

Ordering information is listed in the following table. Both components are required.

Table 75. Ordering information for CTO orders

Part number	Feature code	NVIDIA part number	Description	Maximum quantity
CTO only	BRPK*	MBF2H532C-AECOT	ThinkSystem NVIDIA BlueField-2 25GbE SFP56 2-Port PCIe Ethernet DPU w/BMC & Crypto	2
CTO only	BSH7*	-	ThinkSystem OCP Enablement Kit for Distributed Services Engine	1

* These adapters are only available CTO and only available using DPU-specific CTO model numbers

If you have an existing DPU model with only one DPU installed, you can upgrade to a dual-DPU configuration, using the part numbers listed in the following table. Both the adapter and the NC-SI cable are needed.

Note: The part numbers listed in the table below are not generally orderable. Contact your Lenovo sales representative for ordering information.

Table 76. Field upgrades to add a second DPU to an existing DPU model

Part number	Description	Maximum quantity
4XC7B02131	ThinkSystem NVIDIA BlueField-2 25GbE SFP56 2-Port PCIe Ethernet DPU w/BMC & Crypto	1
4X97B02130	ThinkSystem Adapter NC-SI Cable-270mm	1

Configuration notes:

- The DSE solution requires the OCP adapter; as a result, no other OCP networking adapters are supported
- Configurations with 1x DPU require VMware vSphere 8.0 U1 or later
- Configurations with 2x DPUs require VMware vSphere 8.0 U3 or later
- Part number 4XC7B02131 is for field upgrades only for the DPU-specific CTO models 7D75CTO4WW and 7D76CTO4WW, where the first DPU is already installed
- Part number 4XC7B02131 is not supported in CTO model 7D76CTOGWW.

GPU adapters

This section describes the supported GPUs.

- [GPU part numbers](#)
- [Riser selections for double-wide GPUs](#)
- [GPU Full Length Thermal Option Kit](#)
- [GPU cable kits](#)

GPU part numbers

The SR650 V3 supports the following graphics processing units (GPUs).

Table 77. Supported GPUs

Part number	Feature code	Description	Max qty	Slots supported	PCIe width	TDP	Aux power	Windows 10/11 support
Single-wide GPUs								
4X67A84824	BS2C	ThinkSystem NVIDIA L4 24GB PCIe Gen4 Passive GPU	8	1 - 8	x16	72W	No	Supported
4X67A81547	BQZT	ThinkSystem NVIDIA A2 16GB PCIe Gen4 Passive GPU w/o CEC	8	1-8,11,12	x8	60W	No	Supported
4X67A79777	BMXD	ThinkSystem NVIDIA T1000 8GB PCIe Active GPU	8†	1 - 8	x16	50 W	No	Supported
4X67A79778	BMXE	ThinkSystem NVIDIA T400 4GB PCIe Active GPU	8	1 - 8	x16	30 W	No	Supported
Double-wide GPUs								
4X67A81102	BP04	ThinkSystem AMD Instinct MI210 PCIe Gen4 Passive Accelerator	3	2,5,7*	x16	300W	Yes	No
4X67A89325	BXAK	ThinkSystem NVIDIA H100 NVL 94GB PCIe Gen5 Passive GPU	3	2,5,7*	x16	400W	Yes	Supported
4X67A90669	BYFH	ThinkSystem NVIDIA L40S 48GB PCIe Gen4 Passive GPU	3	2,5,7*	x16	350W	Yes	Supported
4X67A84823	BT87	ThinkSystem NVIDIA L40 48GB PCIe Gen4 Passive GPU	3	2,5,7*	x16	300W	Yes	Supported
CTO only	BQZP	ThinkSystem NVIDIA A100 80GB PCIe Gen4 Passive GPU w/o CEC	3	2,5,7*	x16	300W	Yes	Supported
CTO only	BEL4	ThinkSystem NVIDIA A40 48GB PCIe 4.0 Passive GPU w/o CEC	3	2,5,7*	x16	300W	Yes	Supported
4X67A72593	BQZQ	ThinkSystem NVIDIA A40 48GB PCIe Gen4 Passive GPU w/o CEC	3	2,5,7*	x16	300W	Yes	Supported
4X67A76581	BJHG	ThinkSystem NVIDIA A30 24GB PCIe Gen4 Passive GPU w/o CEC	3	2,5,7*	x16	165W	Yes	Supported
CTO only	BQZR	ThinkSystem NVIDIA A30 24GB PCIe Gen4 Passive GPU w/o CEC	3	2,5,7*	x16	165W	Yes	Supported
4X67A76727	BNFE	ThinkSystem NVIDIA A16 64GB Gen4 PCIe Passive GPU	3	2,5,7*	x16	300W	Yes	Supported
CTO only	BQZU	ThinkSystem NVIDIA A16 64GB Gen4 PCIe Passive GPU w/o CEC	3	2,5,7*	x16	300W	Yes	Supported
4X67A89324	C2DP	ThinkSystem NVIDIA RTX 6000 Ada 48GB PCIe Active GPU	2	2,5*	x16	300W	Yes	Supported
4X67A76720	BMT9	ThinkSystem NVIDIA RTX A2000 12GB PCIe Active GPU	3	2,5,7*	x16	70W	No	Supported

* When a double-wide GPU is installed in slot 2, 5 or 7, the adjacent slot 1, 4 and 8 respectively is not available

† Windows Server 2022 does not support more than 16 displays attached to the server

For information about these GPUs, see the ThinkSystem GPU Summary, available at:

<https://lenovopress.com/lp0768-thinksystem-thinkagile-gpu-summary>

For CTO orders, the SR650 V3 also supports the selection of a placeholder for a GPU. This selection results in a "GPU ready" configuration which ensures that the server ships with the components needed for GPU installation (GPU power cables, air ducts, power supplies, fans, etc) without actually including the GPUs themselves. The following table lists the ordering information for CTO orders.

Table 78. GPU-Ready configurations - ordering information

Part number	Feature code	Description
CTO only	BW40	ThinkSystem NVIDIA A4500 GPU-Ready Installation
CTO only	BVLL	ThinkSystem NVIDIA H100 GPU-Ready Installation
CTO only	BW3Z	ThinkSystem NVIDIA L40 GPU-Ready Installation
CTO only	BZUS	ThinkSystem NVIDIA L40S GPU-Ready Installation
CTO only	BP4X	ThinkSystem DW GPU-Ready Installation (for all other supported DW GPUs)

Configuration rules

The following configuration requirements must be met when installing GPUs:

- Some NVIDIA A Series GPUs are available as two feature codes, one with a CEC chip and one without a CEC chip (ones without the CEC chip have "w/o CEC" in the name). The CEC is a secondary Hardware Root of Trust (RoT) module that provides an additional layer of security, which can be used by customers who have high regulatory requirements or high security standards. NVIDIA uses a multi-layered security model and hence the protection offered by the primary Root of Trust embedded in the GPU is expected to be sufficient for most customers. The CEC defeatured products still offer Secure Boot, Secure Firmware Update, Firmware Rollback Protection, and In-Band Firmware Update Disable. Specifically, without the CEC chip, the GPU does not support Key Revocation or Firmware Attestation. CEC and non-CEC GPUs of the same type of GPU can be mixed in field upgrades.
- All GPUs installed must be identical
- When a double-wide GPU is installed in slot 2, 5 or 7, the adjacent slot 1, 4 and 8 respectively is not available
- Flash storage adapters are not supported.
- Middle drive bays and Rear drive bays are not supported
- 12x 3.5-inch backplanes are not supported
- The following GPUs are not supported with PCIe Gen 5 risers:
 - ThinkSystem NVIDIA T1000 8GB PCIe Active GPU
 - ThinkSystem NVIDIA T400 4GB PCIe Active GPU

The server supports up to 3x double-wide GPUs, however due to thermal requirements, GPU support is affected by the front drive bay configuration and by ambient temperature:

- With 16x 2.5-inch front drives bays:
 - Up to 3x double-wide GPUs are supported, in slots 2, 5, 7
 - For the NVIDIA A40, H100:
 - The use of 3x GPUs requires ambient temperature no higher than 25°C
 - The use of 2x GPUs (slots 2, 5) requires ambient temperature no higher than 30°C
 - All other GPUs: No ambient temperature restrictions-
- With 24x 2.5-inch front drive bays:
 - Up to 2x double-wide GPUs are supported, in slots 2, 5
 - NVIDIA A40: No support
 - All other GPUs: Ambient temperature no higher than 25°C

For additional GPU requirements, see the Thermal rules page in the User Guide:

https://pubs.lenovo.com/sr650-v3/thermal_rules

Riser selections for double-wide GPUs

When a double-wide GPU is installed in slot 2, 5 or 7, the adjacent slot 1, 4 and 8 respectively is not available. The riser cards listed in the following table are used with double-wide GPUs.

Table 79. Risers needed for double-wide GPUs

Riser	Part number	Feature code	Description
Riser 1 (GPU in slot 2) - PCIe Gen5	4XH7A82902	BPQW	ThinkSystem V3 2U E/x16/x16 PCIe Gen5 Riser1 or 2
Riser 1 (GPU in slot 2) - PCIe Gen4	4XH7A82894	BLKN	ThinkSystem V3 2U G4 E/x16/x16 PCIe Riser1 or 2
Riser 2 (GPU in slot 5) - PCIe Gen5	4XH7A82902	BPQW	ThinkSystem V3 2U E/x16/x16 PCIe Gen5 Riser1 or 2
Riser 2 (GPU in slot 5) - PCIe Gen4	4XH7A82894	BLKN	ThinkSystem V3 2U G4 E/x16/x16 PCIe Riser1 or 2
Riser 3 (GPU in slot 7) - PCIe Gen5	4XH7A82907	BLL9	ThinkSystem V3 2U x16/x16 PCIe Gen5 Riser3 Kit
Riser 3 (GPU in slot 7) - PCIe Gen4	4XH7A82905	BPKG	ThinkSystem V3 2U x16/x16 PCIe Gen4 Riser3 Kit with Cage

GPU Full Length Thermal Option Kit

When installing any full-length GPU as a field upgrade, you will also need to order the GPU Enablement Kit as listed in the following table. This kit is only required for full-length GPUs and is not required for low profile GPUs such as the NVIDIA A2, L4, T1000 and T400.

Table 80. ThinkSystem SR650 V3 GPU Full Length Thermal Option Kit

Part number	Description	Maximum supported
4X67A82883	ThinkSystem SR650 V3 GPU Full Length Thermal Option Kit <ul style="list-style-type: none"> ● 2x 1U processor performance heatsinks - replace existing 2U heatsinks (SBB7A53929, BP4Z) ● 1x ThinkSystem 2U GPU air duct - replaces main air baffle (SBB7A43701, BLL5) ● 3x GPU extend air ducts - needed in a zone if an A10 or other single-wide GPU > 75W is installed in the upper slot (SBB7A43702, BLL4) ● 3x Air duct fillers - needed in each riser zone if no GPU is installed in that zone (SBB7A17338, B8MB) ● 3x 8-pin GPU power cables for double-wide GPUs (SBB7A49792, BMPQ) ● 3x 16-pin GPU power cables for double-wide GPUs (SBB7A66338, BRWK) ● 3x GPU power cables for single-wide GPUs and the RTX A4500 (SBB7A44786, BMJL) ● 3x GPU power Y-cables when 2x single-wide GPUs installed on one riser (SBB7A23757, BC09) 	1

The following figure shows the GPU air duct with GPU air duct fillers and GPU extend air ducts installed.

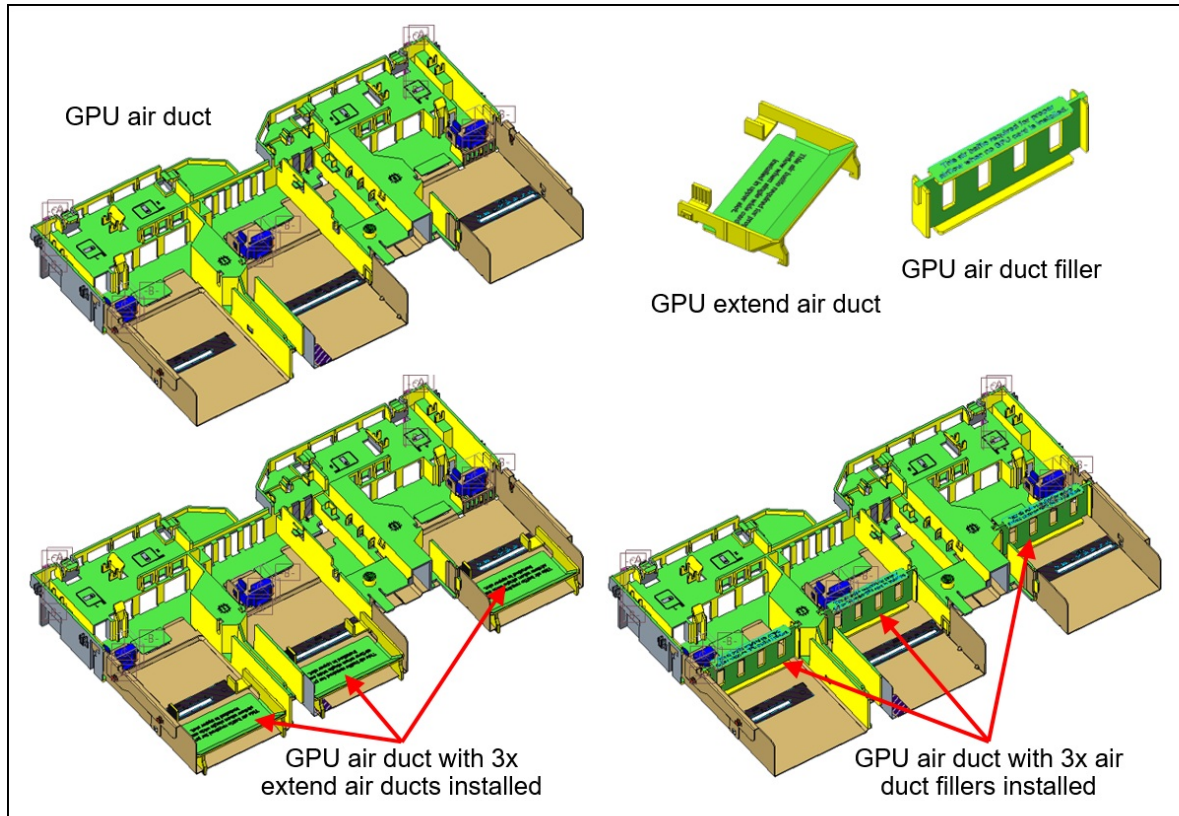

Figure 20. SR650 V3 GPU air duct

GPU cable kits

The following cable kits are offered to provide auxiliary power cables for GPUs that require one. See the [GPU part numbers](#) section to see which GPUs require an auxiliary power cable.

Configuration notes:

- This cable kits are only required for field upgrades; factory (CTO) orders will automatically include any required cables.
- For double-wide GPUs, The DW (double-wide) cable kit is only required if you are adding *additional* double-wide GPUs to a server that already has a DW GPU installed from a CTO order. If you are doing a field upgrade to install the *first* DW GPU to a server, order the ThinkSystem SR650 V3 GPU Full Length Thermal Option Kit, 4X67A82883 instead, since 4X67A82883 includes the necessary power cables.

Table 81. GPU cable kits

Part number	Description
4X97A82948	ThinkSystem SR650 V3 DW GPU Cable Kit <ul style="list-style-type: none"> • 3x 8-pin GPU power cables for double-wide GPUs (SBB7A49792) • 3x GPU power cables for single-wide GPUs and the RTX A4500 (SBB7A44786) • 3x GPU power Y-cables when 2x single-wide GPUs installed on one riser (SBB7A23757) • 3x 16-pin GPU power cables for double-wide GPUs (SBB7A66338)

Fibre Channel host bus adapters

The following table lists the Fibre Channel HBAs supported by the SR650 V3.

No Windows 10/11 support: None of the adapters listed in the table are supported with Windows 10 or Windows 11.

Table 82. Fibre Channel HBAs

Part number	Feature code	Description	Max qty	Slots supported	PCIe lanes
64 Gb Fibre Channel HBAs					
4XC7A77485	BLC1	ThinkSystem Emulex LPe36002 64Gb 2-port PCIe Fibre Channel Adapter	12	All slots	Gen4 x8
32 Gb Fibre Channel HBAs					
4XC7A76498	BJ3G	ThinkSystem Emulex LPe35000 32Gb 1-port PCIe Fibre Channel Adapter v2	12	All slots	Gen4 x8
4XC7A76525	BJ3H	ThinkSystem Emulex LPe35002 32Gb 2-port PCIe Fibre Channel Adapter V2	12	All slots	Gen4 x8
4XC7A08279	BA1G	ThinkSystem QLogic QLE2770 32Gb 1-Port PCIe Fibre Channel Adapter	12	All slots	Gen4 x8
4XC7A08276	BA1F	ThinkSystem QLogic QLE2772 32Gb 2-Port PCIe Fibre Channel Adapter	12	All slots	Gen4 x8
16 Gb Fibre Channel HBAs					
01CV840	ATZV	Emulex 16Gb Gen6 FC Dual-port HBA	12	All slots	Gen3 x8
01CV830	ATZU	Emulex 16Gb Gen6 FC Single-port HBA	12	All slots	Gen3 x8
01CV760	ATZC	QLogic 16Gb Enhanced Gen5 FC Dual-port HBA	12	All slots	Gen3 x8
01CV750	ATZB	QLogic 16Gb Enhanced Gen5 FC Single-port HBA	12	All slots	Gen3 x8

For more information, see the list of Lenovo Press Product Guides in the Host bus adapters category:

<https://lenovopress.com/servers/options/hba>

SAS adapters for external storage

The following table lists SAS HBAs and RAID adapters supported by SR650 V3 server for use with external storage.

No Windows 10/11 support: None of the adapters listed in the table are supported with Windows 10 or Windows 11.

Table 83. Adapters for external storage

Part number	Feature code	Description	Max qty	Slots supported	PCIe lanes
SAS HBAs					
4Y37A78837	BNWK	ThinkSystem 440-8e SAS/SATA PCIe Gen4 12Gb HBA	12	All slots	Gen4 x8
4Y37A09724	B8P7	ThinkSystem 440-16e SAS/SATA PCIe Gen4 12Gb HBA	12	All slots	Gen4 x8
External RAID adapters					
4Y37A78836	BNWJ	ThinkSystem RAID 940-8e 4GB Flash PCIe Gen4 12Gb Adapter	4*	All slots	Gen4 x8

* See below regarding supercap requirements

For a comparison of the functions of the supported storage adapters, see the ThinkSystem RAID Adapter and HBA Reference:

<https://lenovopress.lenovo.com/lp1288#sr650-v3-support=SR650%2520V3&internal-or-external-ports=External>

The RAID 940-8e adapter uses a flash power module (supercap), which can be installed in one of up to 4 locations in the server depending on the server configuration. See the [RAID flash power module \(supercap\) support](#) section for details. The number of 940-8e RAID adapters supported is based on how many supercaps can be installed in the server. If an internal RAID adapter with flash power modules is installed, the maximum number of 940-8e adapters supported is reduced by 1.

For more information, see the list of Lenovo Press Product Guides in the Host bus adapters and RAID adapters categories:

<https://lenovopress.com/servers/options/hba>

<https://lenovopress.com/servers/options/raid>

Flash storage adapters

The SR650 V3 currently does not support PCIe Flash Storage adapters.

Cooling

The SR650 V3 server has up to six 60 mm hot-swap variable-speed fans. Five fans are needed when one processor is installed and six fans are required when two processors are installed. The server offers N+1 redundancy. The server also has one or two additional fans integrated in each of the two power supplies.

Depending on the configuration, the server will need either Standard fans (single-rotor 17K RPM) or Performance fans (dual-rotor 21K RPM).

Under the following conditions, Standard fans can be used:

- Processor TDP < 270W
- No 128 GB or 256GB 3DS RDIMMs
- No mid-chassis or rear drive backplanes
- No GPUs
- No low profile slots 7, 8, 9 & 10
- No internal (CFF) HBA/RAID adapter
- A configuration with 24x 2.5" or 12x 3.5" front backplanes and without any following network adapters:
 - Any 100Gb, 200Gb or 400Gb adapter
 - ThinkSystem Broadcom 57454 10/25GbE SFP28 4-port OCP Ethernet Adapter, 4XC7A08242
 - ThinkSystem Broadcom 57416 10GBASE-T 2-port OCP Ethernet Adapter, 4XC7A08236
 - ThinkSystem NVIDIA BlueField-2 25GbE SFP56 2-Port PCIe Ethernet DPU w/BMC & Crypto, BRPK
- Not the following configurations:
 - 12x 3.5-inch front drive bays with an OCP adapter installed
- Ambient temperature 35°C or lower

If any conditions are not met, Performance fans are required.

Ordering information for the fans is listed in the following table.

Table 84. Fan ordering information

Part number	Feature code	Description	Quantity required
4F17A14497	BH8F	ThinkSystem V3 2U Standard Fan Option Kit	1x CPU: 5 2x CPUs: 6
4F17A82884	BLL6	ThinkSystem V3 2U Performance Fan Option Kit	1x CPU: 5 2x CPUs: 6

Power supplies

The SR650 V3 supports up to two redundant hot-swap power supplies.

The power supply choices are listed in the following table. Both power supplies used in server must be identical.

Tip: When configuring a server in the DCSC configurator, power consumption is calculated precisely by interfacing with Lenovo Capacity Planner. You can therefore select the appropriate power supply for your configuration. However, do consider future upgrades that may require additional power needs.

Table 85. Power supply options

Part number	Feature code	Description	Connector	Max quantity	110V AC	220V AC	240V DC PRC only	-48V DC
AC input power - 80 PLUS Titanium efficiency								
4P57A82019	BR1X	ThinkSystem 750W 230V Titanium Hot-Swap Gen2 Power Supply v3	C13	2	No	Yes	Yes	No
CTO only	C07V	ThinkSystem 750W 230V Titanium Hot-Swap Gen2 Power Supply v4	C13	2	No	Yes	Yes	No
4P57A72666	BLKH	ThinkSystem 1100W 230V Titanium Hot-Swap Gen2 Power Supply	C13	2	No	Yes	Yes	No
4P57A78359	BPK9	ThinkSystem 1800W 230V Titanium Hot-Swap Gen2 Power Supply	C13	2	No	Yes	Yes	No
4P57A72667	BKTJ	ThinkSystem 2600W 230V Titanium Hot-Swap Gen2 Power Supply v4	C19	2	No	Yes	Yes	No
AC input power - 80 PLUS Platinum efficiency								
4P57A72670	BNFG	ThinkSystem 750W 230V/115V Platinum Hot-Swap Gen2 Power Supply v3	C13	2	Yes	Yes	Yes	No
4P57A72671	BNFH	ThinkSystem 1100W 230V/115V Platinum Hot-Swap Gen2 Power Supply v3	C13	2	Yes	Yes	Yes	No
4P57A78362	BMUF	ThinkSystem 1800W 230V Platinum Hot-Swap Gen2 Power Supply v2	C13	2	No	Yes	Yes	No
4P57A26295	B962	ThinkSystem 2400W 230V Platinum Hot-Swap Gen2 Power Supply	C19	2	No	Yes	Yes	No
-48V DC input power								
4P57A26296	B8QE	ThinkSystem 1100W -48V DC Hot-Swap Gen2 Power Supply	DC	2	No	No	No	Yes

Supported power supplies are auto-sensing dual-voltage units, supporting both 110V AC (100-127V 50/60 Hz) and 220V AC (200-240V 50/60 Hz) power. For China customers, all power supplies support 240V DC.

AC power supplies up to 1800W have a C14 connector. AC power supplies 2400W and above have a C19 connector.

The supported -48V DC power supply has a Weidmuller TOP 4GS/3 7.6 terminal as shown in the following figure.

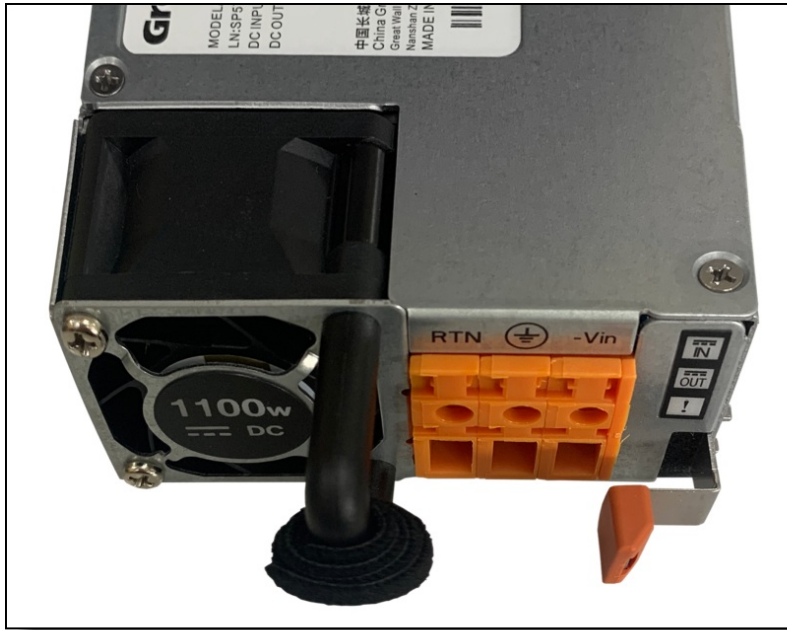

Figure 21. Connector on the ThinkSystem 1100W -48V DC Hot-Swap Gen2 Power Supply

Power supply options do not include a line cord. For server configurations, the inclusion of a power cord is model dependent. Configure-to-order models can be configured without power cords if desired.

Power supply LEDs

The supported hot-swap power supplies have the following LEDs:

- Power input LED:
 - Green: The power supply is connected to the AC power source
 - Off: The power supply is disconnected from the AC power source or a power problem has occurred
- Power output LED:
 - Green: The server is on and the power supply is working normally
 - Blinking green: The power supply is in Zero-output/Standby mode (see below)
 - Off: The server is powered off, or the power supply is not working properly
- Power supply error LED:
 - Off: The power supply is working normally
 - Yellow: The power supply has failed

Zero-output mode: When Zero-output mode (also known as Standby mode or Cold Redundancy mode) is configured in XCC and the server power load is sufficiently low, one of the installed power supplies enters into the Standby state while the other one delivers entire load. When the power load increases, the standby power supply will switch to Active state to provide sufficient power to the server. Zero-output mode can be enabled or disabled in the XClarity Controller web interface, Server Configuration > Power Policy. If you select Disable, then both power supplies will be in the Active state.

Power cords

Line cords and rack power cables with C13 connectors can be ordered as listed in the following table.

110V customers: If you plan to use the 1100W power supply with a 110V power source, select a power cable that is rated above 10A. Power cables that are rated at 10A or below are not supported with 110V power.

Table 86. Power cords

Part number	Feature code	Description
Rack cables - C13 to C14		
SL67B08593	BPHZ	0.5m, 10A/100-250V, C13 to C14 Jumper Cord
00Y3043	A4VP	1.0m, 10A/100-250V, C13 to C14 Jumper Cord
4L67A08367	B0N5	1.0m, 13A/100-250V, C13 to C14 Jumper Cord
39Y7937	6201	1.5m, 10A/100-250V, C13 to C14 Jumper Cord
4L67A08368	B0N6	1.5m, 13A/100-250V, C13 to C14 Jumper Cord
4L67A08365	B0N4	2.0m, 10A/100-250V, C13 to IEC 320-C14 Rack Power Cable
4L67A08369	6570	2.0m, 13A/100-250V, C13 to C14 Jumper Cord
4L67A08366	6311	2.8m, 10A/100-250V, C13 to C14 Jumper Cord
4L67A08370	6400	2.8m, 13A/100-250V, C13 to C14 Jumper Cord
39Y7932	6263	4.3m, 10A/100-250V, C13 to IEC 320-C14 Rack Power Cable
4L67A08371	6583	4.3m, 13A/100-250V, C13 to C14 Rack Power Cable
Rack cables - C13 to C14 (Y-cable)		
00Y3046	A4VQ	1.345m, 2X C13 to C14 Jumper Cord, Rack Power Cable
00Y3047	A4VR	2.054m, 2X C13 to C14 Jumper Cord, Rack Power Cable
Rack cables - C13 to C20		
39Y7938	6204	2.8m, 10A/100-250V, C13 to IEC 320-C20 Rack Power Cable
Rack cables - C13 to C20 (Y-cable)		
47C2491	A3SW	1.2m, 16A/100-250V, 2 Short C13s to Short C20 Rack Power Cable
47C2492	A3SX	2.5m, 16A/100-250V, 2 Long C13s to Short C20 Rack Power Cable
47C2493	A3SY	2.8m, 16A/100-250V, 2 Short C13s to Long C20 Rack Power Cable
47C2494	A3SZ	4.1m, 16A/100-250V, 2 Long C13s to Long C20 Rack Power Cable
Line cords		
39Y7930	6222	2.8m, 10A/250V, C13 to IRAM 2073 (Argentina) Line Cord
81Y2384	6492	4.3m 10A/220V, C13 to IRAM 2073 (Argentina) Line Cord
39Y7924	6211	2.8m, 10A/250V, C13 to AS/NZ 3112 (Australia/NZ) Line Cord
81Y2383	6574	4.3m, 10A/230V, C13 to AS/NZS 3112 (Aus/NZ) Line Cord
69Y1988	6532	2.8m, 10A/250V, C13 to NBR 14136 (Brazil) Line Cord
81Y2387	6404	4.3m, 10A/250V, C13 - 2P+Gnd (Brazil) Line Cord
39Y7928	6210	2.8m, 220-240V, C13 to GB 2099.1 (China) Line Cord
81Y2378	6580	4.3m, 10A/220V, C13 to GB 2099.1 (China) Line Cord
39Y7918	6213	2.8m, 10A/250V, C13 to DK2-5a (Denmark) Line Cord
81Y2382	6575	4.3m, 10A/230V, C13 to DK2-5a (Denmark) Line Cord
39Y7917	6212	2.8m, 10A/230V, C13 to CEE7-VII (Europe) Line Cord
81Y2376	6572	4.3m, 10A/230V, C13 to CEE7-VII (Europe) Line Cord
39Y7927	6269	2.8m, 10A/250V, C13(2P+Gnd) (India) Line Cord
81Y2386	6567	4.3m, 10A/240V, C13 to IS 6538 (India) Line Cord
39Y7920	6218	2.8m, 10A/250V, C13 to SI 32 (Israel) Line Cord
81Y2381	6579	4.3m, 10A/230V, C13 to SI 32 (Israel) Line Cord
39Y7921	6217	2.8m, 220-240V, C13 to CEI 23-16 (Italy/Chile) Line Cord
81Y2380	6493	4.3m, 10A/230V, C13 to CEI 23-16 (Italy/Chile) Line Cord

Part number	Feature code	Description
46M2593	A1RE	2.8m, 12A/125V, C13 to JIS C-8303 (Japan) Line Cord
4L67A08362	6495	4.3m, 12A/200V, C13 to JIS C-8303 (Japan) Line Cord
39Y7926	6335	4.3m, 12A/100V, C13 to JIS C-8303 (Japan) Line Cord
39Y7922	6214	2.8m, 10A/250V, C13 to SABS 164 (S Africa) Line Cord
81Y2379	6576	4.3m, 10A/230V, C13 to SABS 164 (South Africa) Line Cord
39Y7925	6219	2.8m, 220-240V, C13 to KETI (S Korea) Line Cord
81Y2385	6494	4.3m, 12A/220V, C13 to KSC 8305 (S. Korea) Line Cord
39Y7919	6216	2.8m, 10A/250V, C13 to SEV 1011-S24507 (Swiss) Line Cord
81Y2390	6578	4.3m, 10A/230V, C13 to SEV 1011-S24507 (Sws) Line Cord
23R7158	6386	2.8m, 10A/125V, C13 to CNS 10917-3 (Taiwan) Line Cord
81Y2375	6317	2.8m, 10A/240V, C13 to CNS 10917-3 (Taiwan) Line Cord
81Y2374	6402	2.8m, 13A/125V, C13 to CNS 60799 (Taiwan) Line Cord
4L67A08363	AX8B	4.3m, 10A 125V, C13 to CNS 10917 (Taiwan) Line Cord
81Y2389	6531	4.3m, 10A/250V, C13 to 76 CNS 10917-3 (Taiwan) Line Cord
81Y2388	6530	4.3m, 13A/125V, C13 to CNS 10917 (Taiwan) Line Cord
39Y7923	6215	2.8m, 10A/250V, C13 to BS 1363/A (UK) Line Cord
81Y2377	6577	4.3m, 10A/230V, C13 to BS 1363/A (UK) Line Cord
90Y3016	6313	2.8m, 10A/120V, C13 to NEMA 5-15P (US) Line Cord
46M2592	A1RF	2.8m, 10A/250V, C13 to NEMA 6-15P Line Cord
00WH545	6401	2.8m, 13A/120V, C13 to NEMA 5-15P (US) Line Cord
4L67A08359	6370	4.3m, 10A/125V, C13 to NEMA 5-15P (US) Line Cord
4L67A08361	6373	4.3m, 10A/250V, C13 to NEMA 6-15P (US) Line Cord
4L67A08360	AX8A	4.3m, 13A/120V, C13 to NEMA 5-15P (US) Line Cord

Power cords (C19 connectors)

Line cords and rack power cables with C19 connectors can be ordered as listed in the following table.

Table 87. Power cords (C19 connectors)

Part number	Feature code	Description
Rack cables		
4L67A86677	BPJ0	0.5m, 16A/100-250V, C19 to IEC 320-C20 Rack Power Cable
4L67A86678	B4L0	1.0m, 16A/100-250V, C19 to IEC 320-C20 Rack Power Cable
4L67A86679	B4L1	1.5m, 16A/100-250V, C19 to IEC 320-C20 Rack Power Cable
4L67A86680	B4L2	2.0m, 16A/100-250V, C19 to IEC 320-C20 Rack Power Cable
39Y7916	6252	2.5m, 16A/100-240V, C19 to IEC 320-C20 Rack Power Cable
4L67A86681	B4L3	4.3m, 16A/100-250V, C19 to IEC 320-C20 Rack Power Cable
Line cords		
40K9777	6276	4.3m, 220-240V, C19 to IRAM 2073 (Argentina) Line cord
40K9773	6284	4.3m, 220-240V, C19 to AS/NZS 3112 (Aus/NZ) Line cord
40K9775	6277	4.3m, 250V, C19 to NBR 14136 (Brazil) Line Cord
40K9774	6288	4.3m, 220-240V, C19 to GB2099.1 (China) Line cord
40K9769	6283	4.3m, 16A/230V, C19 to IEC 309-P+N+G (Den/Sws) Line Cord
40K9766	6279	4.3m, 220-240V, C19 to CEE7-VII (European) Line cord

Part number	Feature code	Description
40K9776	6285	4.3m, 220-240V, C19 to IS6538 (India) Line cord
40K9771	6282	4.3m, 220-240V, C19 to SI 32 (Israel) Line cord
40K9768	6281	4.3m, 220-240V, C19 to CEI 23-16 (Italy) Line cord
40K9770	6280	4.3m, 220-240V, C19 to SABS 164 (South Africa) Line cord
41Y9231	6289	4.3m, 15A/250V, C19 to KSC 8305 (S. Korea) Line Cord
81Y2391	6549	4.3m, 16A/230V, C19 to SEV 1011 (Sws) Line Cord
41Y9230	6287	4.3m, 16A/250V, C19 to CNS 10917-3 (Taiwan) Line Cord
40K9767	6278	4.3m, 220-240V, C19 to BS 1363/A w/13A fuse (UK) Line Cord
40K9772	6275	4.3m, 16A/208V, C19 to NEMA L6-20P (US) Line Cord
00D7197	A1NV	4.3m, 15A/250V, C19 to NEMA 6-15P (US) Line Cord

-48V DC power cord

For the -48V DC Power Supply, the following power cable is supported.

Table 88. -48V DC power cable

Part number	Feature code	Description
4X97A59831	BE4V	2.5m, -48VDC Interconnecting Cable

Systems management

The SR650 V3 contains an integrated service processor, XClarity Controller 2 (XCC2), which provides advanced control, monitoring, and alerting functions. The XCC2 is based on the AST2600 baseboard management controller (BMC) using a dual-core ARM Cortex A7 32-bit RISC service processor running at 1.2 GHz.

Topics in this section:

- [System I/O Board](#)
- [Local management](#)
- [System status with XClarity Mobile](#)
- [Remote management](#)
- [XCC2 Platinum](#)
- [Lenovo XClarity Provisioning Manager](#)
- [Lenovo XClarity Administrator](#)
- [Lenovo XClarity Integrators](#)
- [Lenovo XClarity Essentials](#)
- [Lenovo XClarity Energy Manager](#)
- [Lenovo Capacity Planner](#)

System I/O Board

The SR650 V3 implements a separate System I/O Board that connects to the Processor Board. The location of the System I/O Board is shown in the [Components and connectors](#) section. The System I/O Board contains all the connectors visible at the rear of the server as shown in the following figure.

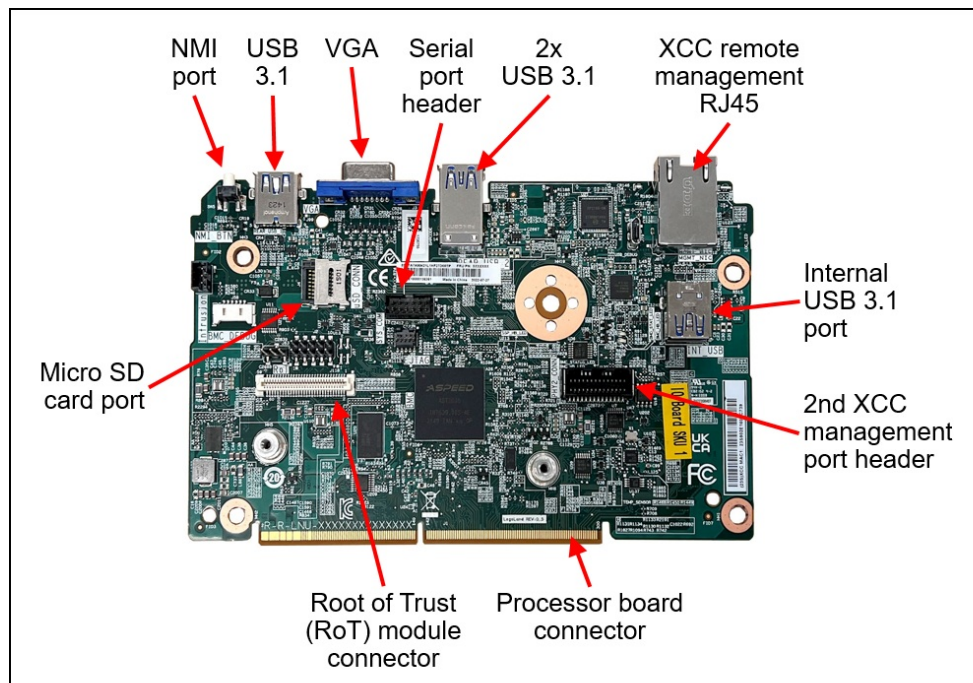

Figure 22. System I/O Board

The board also has the following components:

- XClarity Controller 2, implemented using the ASPEED AST2600 baseboard management controller (BMC).
- Root of Trust (RoT) module - a daughter card that implements Platform Firmware Resiliency (PFR) hardware Root of Trust (RoT) which enables the server to be NIST SP800-193 compliant. For more details about PFR, see the [Security](#) section.

- Connector to enable an additional redundant Ethernet connection to the XCC2 controller. The connector is used in conjunction with the ThinkSystem V3 Management NIC Adapter Kit (4XC7A85319). For details, see the [Remote management](#) section.
 - Internal USB port - to allow the booting of an operating system from a USB key. The VMware ESXi preloads use this port for example. Preloads are described in the [Operating system support](#) section.
 - MicroSD card port to enable the use of a MicroSD card for additional storage for use with the XCC2 controller. XCC2 can use the storage as a Remote Disc on Card (RDOC) device (up to 4GB of storage). It can also be used to store firmware updates (including N-1 firmware history) for ease of deployment.
- Tip:** Without a MicroSD card installed, the XCC2 controller will have 100MB of available RDOC storage.

Ordering information for the supported USB drive and Micro SD card are listed in the following table.

Table 89. Media for use with the System I/O Board

Part number	Feature code	Description
4X77A77065	BNWN	ThinkSystem USB 32GB USB 3.0 Flash Drive
4X77A77064	BNWP	ThinkSystem MicroSD 32GB Class 10 Flash Memory Card
4X77A92672	C0BC	ThinkSystem MicroSD 64GB Class 10 Flash Memory Card

Local management

The SR650 V3 offers a front operator panel with key LED status indicators, as shown in the following figure.

Tip: The Network LED only shows network activity of the installed OCP network adapter.

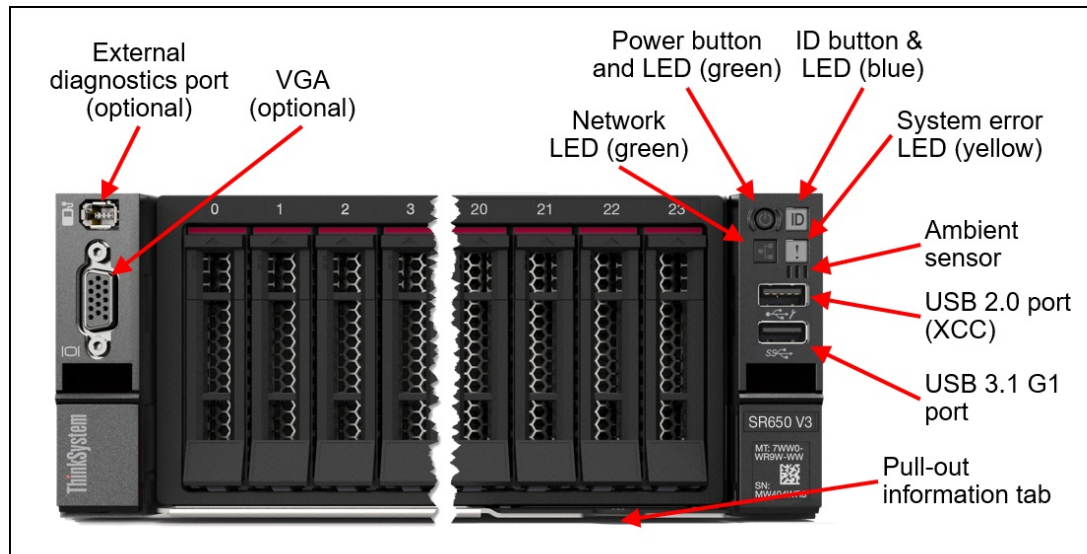

Figure 23. Front operator controls are on the left and right side of the server

Light path diagnostics

The server offers light path diagnostics. If an environmental condition exceeds a threshold or if a system component fails, XCC lights LEDs inside the server to help you diagnose the problem and find the failing part. The server has fault LEDs next to the following components:

- Each memory DIMM
- Each drive bay
- Each power supply

Front VGA and External Diagnostics ports

The VGA port at the rear of the server is included in all models, however the VGA port at the front of the server is optional. Also optional is the External Diagnostics port which enables the use of the External Diagnostics Handset.

To configure either the VGA port or the External Diagnostics port at the front of the server, select one of the following feature codes when configuring the server.

Table 90. Front VGA port

Part number	Feature code	Description	Front VGA port	External diagnostics port
CTO only	BQQ2	ThinkSystem 2U V3 EIA Latch Standard	No	No
4XH7A86164	BQQ1	ThinkSystem V3 2U EIA Latch with VGA & External Diagnostics Ports	Included	Included
4X97A87065	BQQ4	ThinkSystem 2U V3 EIA Latch with External Diagnostics Port	No	Included
4X97A87067	BQQ3	ThinkSystem 2U V3 EIA Latch with VGA Port	Included	No

External Diagnostics Handset

The SR650 V3 optionally has a port to connect an External Diagnostics Handset as described in the preceding section. The External Diagnostics Handset has the same functions as the Integrated Diagnostics Panel but has the advantages of not consuming space on the front of the server plus it can be shared among many servers in your data center. The handset has a magnet on the back of it to allow you to easily mount it on a convenient place on any rack cabinet.

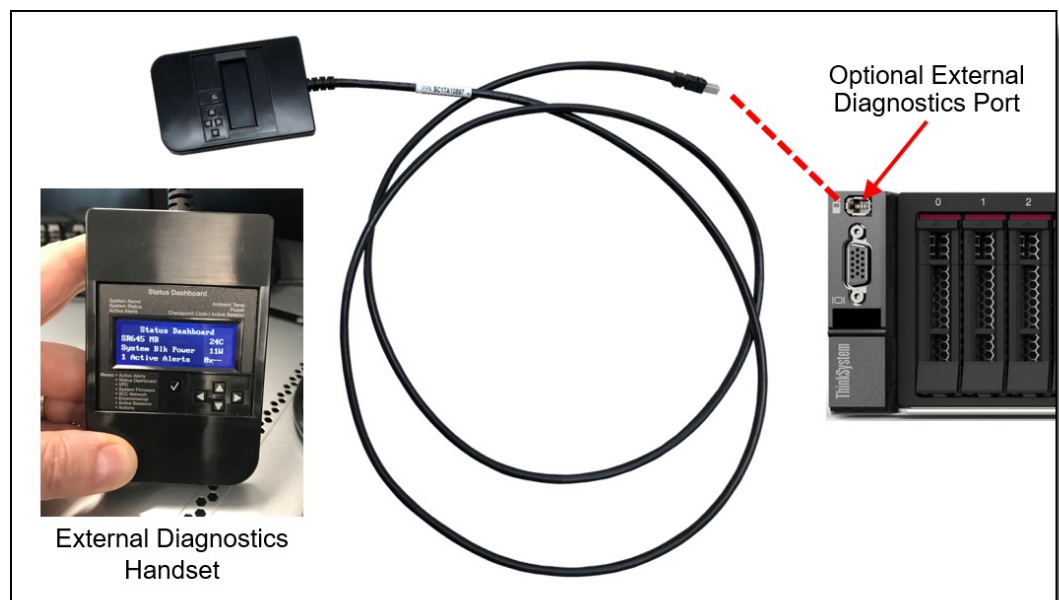

Figure 24. External Diagnostics Handset

Ordering information for the External Diagnostics Handset with is listed in the following table.

Table 91. External Diagnostics Handset ordering information

Part number	Feature code	Description
4TA7A64874	BEUX	ThinkSystem External Diagnostics Handset

Integrated Diagnostics Panel for 8x 2.5-inch and 16x 2.5-inch drive bay configurations

For configurations with 8x 2.5-inch or 16x 2.5-inch drive bays at the front, the server can optionally be configured to have a pull-out Integrated Diagnostics Panel. The following figure shows the standard (fixed) operator panel and the optional Integrated Diagnostics Panel.

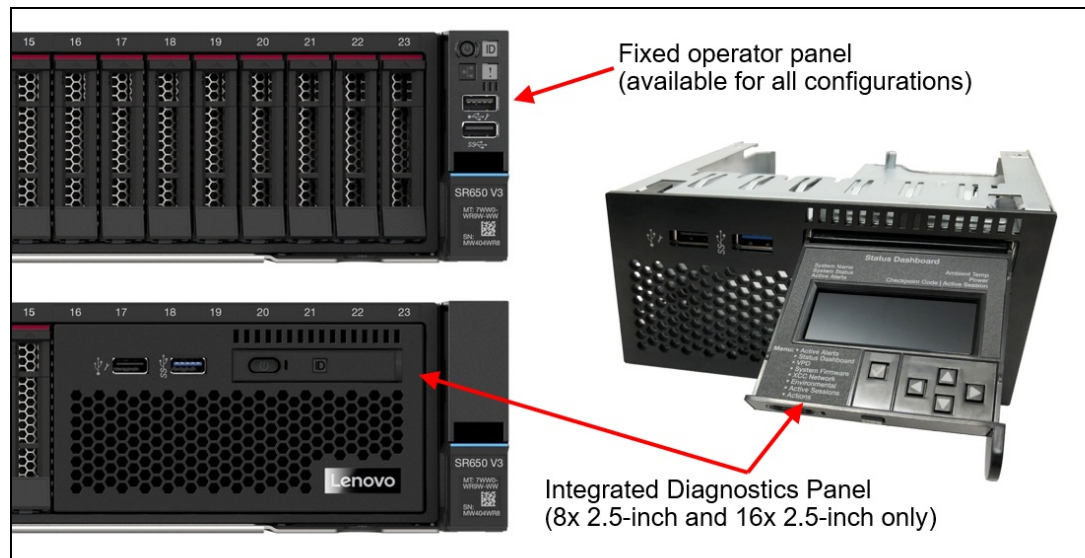

Figure 25. Operator panel choices for the 8x 2.5-inch drive bay configuration

The Integrated Diagnostics Panel allows quick access to system status, firmware, network, and health information. The LCD display on the panel and the function buttons give you access to the following information:

- Active alerts
- Status Dashboard
- System VPD: machine type & mode, serial number, UUID string
- System firmware levels: UEFI and XCC firmware
- XCC network information: hostname, MAC address, IP address, DNS addresses
- Environmental data: Ambient temperature, CPU temperature, AC input voltage, estimated power consumption
- Active XCC sessions
- System reset action

The Integrated Diagnostics Panel can be configured as listed in the following table. It is only available configure-to-order (CTO); not available as a field upgrade.

Table 92. Ordering information for the Integrated Diagnostics Panel

Part number	Feature code	Description
CTO only	BMJA	ThinkSystem 2U 16x2.5" Front Operator Panel v2

Information pull-out tab

The front of the server also houses an information pull-out tab (also known as the network access tag). See [Figure 2](#) for the location. A label on the tab shows the network information (MAC address and other data) to remotely access the service processor.

System status with XClarity Mobile

The XClarity Mobile app includes a tethering function where you can connect your Android or iOS device to the server via USB to see the status of the server.

The steps to connect the mobile device are as follows:

1. Enable USB Management on the server, by holding down the ID button for 3 seconds (or pressing the dedicated USB management button if one is present)
2. Connect the mobile device via a USB cable to the server's USB port with the management symbol 
3. In iOS or Android settings, enable Personal Hotspot or USB Tethering
4. Launch the Lenovo XClarity Mobile app

Once connected you can see the following information:

- Server status including error logs (read only, no login required)
- Server management functions (XClarity login credentials required)

Remote management

The server offers a dedicated RJ45 port at the rear of the server for remote management via the XClarity Controller management processor. The port supports 10/100/1000 Mbps speeds.

Remote server management is provided through industry-standard interfaces:

- Intelligent Platform Management Interface (IPMI) Version 2.0
- Simple Network Management Protocol (SNMP) Version 3 (no SET commands; no SNMP v1)
- Common Information Model (CIM-XML)
- Representational State Transfer (REST) support
- Redfish support (DMTF compliant)
- Web browser - HTML 5-based browser interface (Java and ActiveX not required) using a responsive design (content optimized for device being used - laptop, tablet, phone) with NLS support

The SR650 V3 also supports the use of an OCP adapter that provides an additional redundant Ethernet connection to the XCC2 controller. Ordering information is listed in the following table.

Table 93. Redundant System Management Port Adapter

Part number	Feature code	Description	Maximum quantity
4XC7A85319	BTMQ	ThinkSystem V3 Management NIC Adapter Kit	1

The use of this adapter allows concurrent remote access using both the connection on the adapter and the onboard RJ45 remote management port provided by the server. The adapter and onboard port have separate IP addresses.

Configuration rules:

- The Redundant System Management Port Adapter is installed in the OCP adapter slot at the rear of the server and is mutually exclusive with any OCP network adapter.
- It is not supported installed in the front OCP slot (if the front OCP slot is configured)
- If the Redundant System Management Port Adapter is installed in the rear slot, then the front OCP slot (if configured) cannot be used.

The following figure shows the server with the Redundant System Management Port Adapter installed in the OCP slot.

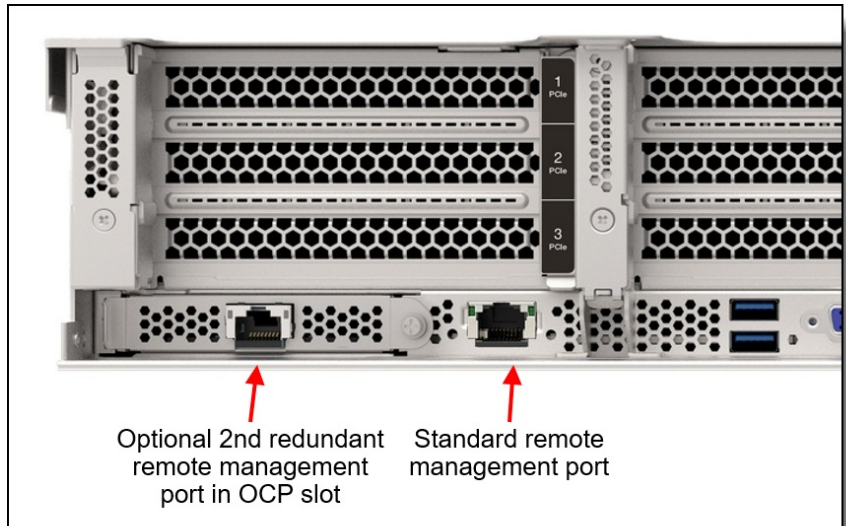

Figure 26. SR650 V3 with the Redundant System Management Port Adapter installed

IPMI via the Ethernet port (IPMI over LAN) is supported, however it is disabled by default. For CTO orders you can specify whether you want the feature enabled or disabled in the factory, using the feature codes listed in the following table.

Table 94. IPMI-over-LAN settings

Feature code	Description
B7XZ	Disable IPMI-over-LAN (default)
B7Y0	Enable IPMI-over-LAN

XCC2 Platinum

The XCC2 service processor in the SR650 V3 supports an upgrade to the Platinum level of features. Compared to the XCC functions of ThinkSystem V2 and earlier systems, Platinum adds the same features as Enterprise and Advanced levels in ThinkSystem V2, plus additional features.

XCC2 Platinum adds the following Enterprise and Advanced functions:

- Remotely viewing video with graphics resolutions up to 1600x1200 at 75 Hz with up to 23 bits per pixel, regardless of the system state
- Remotely accessing the server using the keyboard and mouse from a remote client
- International keyboard mapping support
- Syslog alerting
- Redirecting serial console via SSH
- Component replacement log (Maintenance History log)
- Access restriction (IP address blocking)
- Lenovo SED security key management
- Displaying graphics for real-time and historical power usage data and temperature
- Boot video capture and crash video capture
- Virtual console collaboration - Ability for up to 6 remote users to be log into the remote session simultaneously
- Remote console Java client
- Mapping the ISO and image files located on the local client as virtual drives for use by the server
- Mounting the remote ISO and image files via HTTPS, SFTP, CIFS, and NFS
- Power capping
- System utilization data and graphic view
- Single sign on with Lenovo XClarity Administrator
- Update firmware from a repository

- License for XClarity Energy Manager

XCC2 Platinum also adds the following features that are new to XCC2:

- System Guard - Monitor hardware inventory for unexpected component changes, and simply log the event or prevent booting
- Enterprise Strict Security mode - Enforces CNSA 1.0 level security
- Neighbor Group - Enables administrators to manage and synchronize configurations and firmware level across multiple servers

Ordering information is listed in the following table. XCC2 Platinum is a software license upgrade - no additional hardware is required.

Table 95. XCC2 Platinum license upgrade

Part number	Feature code	Description
7S0X000KWW	SBCV	Lenovo XClarity Controller 2 (XCC2) Platinum Upgrade

With XCC2 Platinum, for CTO orders, you can request that System Guard be enabled in the factory and the first configuration snapshot be recorded. To add this to an order, select feature code listed in the following table. The selection is made in the Security tab of the DCSC configurator.

Table 96. Enable System Guard in the factory (CTO orders)

Feature code	Description
BUT2	Install System Guard

For more information about System Guard, see https://pubs.lenovo.com/xcc2/NN1ia_c_systemguard

Lenovo XClarity Provisioning Manager

Lenovo XClarity Provisioning Manager (LXPM) is a UEFI-based application embedded in ThinkSystem servers and accessible via the F1 key during system boot.

LXPM provides the following functions:

- Graphical UEFI Setup
- System inventory information and VPD update
- System firmware updates (UEFI and XCC)
- RAID setup wizard
- OS installation wizard (including unattended OS installation)
- Diagnostics functions

Lenovo XClarity Administrator

Lenovo XClarity Administrator is a centralized resource management solution designed to reduce complexity, speed response, and enhance the availability of Lenovo systems and solutions. It provides agent-free hardware management for ThinkSystem servers, in addition to ThinkServer, System x, and Flex System servers. The administration dashboard is based on HTML 5 and allows fast location of resources so tasks can be run quickly.

Because Lenovo XClarity Administrator does not require any agent software to be installed on the managed endpoints, there are no CPU cycles spent on agent execution, and no memory is used, which means that up to 1GB of RAM and 1 - 2% CPU usage is saved, compared to a typical managed system where an agent is required.

Lenovo XClarity Administrator is an optional software component for the SR650 V3. The software can be downloaded and used at no charge to discover and monitor the SR650 V3 and to manage firmware upgrades.

If software support is required for Lenovo XClarity Administrator, or premium features such as configuration management and operating system deployment are required, Lenovo XClarity Pro software subscription should be ordered. Lenovo XClarity Pro is licensed on a per managed system basis, that is, each managed Lenovo system requires a license.

The following table lists the Lenovo XClarity software license options.

Table 97. Lenovo XClarity Pro ordering information

Part number	Feature code	Description
00MT201	1339	Lenovo XClarity Pro, per Managed Endpoint w/1 Yr SW S&S
00MT202	1340	Lenovo XClarity Pro, per Managed Endpoint w/3 Yr SW S&S
00MT203	1341	Lenovo XClarity Pro, per Managed Endpoint w/5 Yr SW S&S
7S0X000HWW	SAYV	Lenovo XClarity Pro, per Managed Endpoint w/6 Yr SW S&S
7S0X000JWW	SAYW	Lenovo XClarity Pro, per Managed Endpoint w/7 Yr SW S&S

Lenovo XClarity Administrator offers the following standard features that are available at no charge:

- Auto-discovery and monitoring of Lenovo systems
- Firmware updates and compliance enforcement
- External alerts and notifications via SNMP traps, syslog remote logging, and e-mail
- Secure connections to managed endpoints
- NIST 800-131A or FIPS 140-2 compliant cryptographic standards between the management solution and managed endpoints
- Integration into existing higher-level management systems such as cloud automation and orchestration tools through REST APIs, providing extensive external visibility and control over hardware resources
- An intuitive, easy-to-use GUI
- Scripting with Windows PowerShell, providing command-line visibility and control over hardware resources

Lenovo XClarity Administrator offers the following premium features that require an optional Pro license:

- Pattern-based configuration management that allows to define configurations once and apply repeatedly without errors when deploying new servers or redeploying existing servers without disrupting the fabric
- Bare-metal deployment of operating systems and hypervisors to streamline infrastructure provisioning

For more information, refer to the Lenovo XClarity Administrator Product Guide:

<http://lenovopress.com/tips1200>

Lenovo XClarity Integrators

Lenovo also offers software plug-in modules, Lenovo XClarity Integrators, to manage physical infrastructure from leading external virtualization management software tools including those from Microsoft and VMware.

These integrators are offered at no charge, however if software support is required, a Lenovo XClarity Pro software subscription license should be ordered.

Lenovo XClarity Integrators offer the following additional features:

- Ability to discover, manage, and monitor Lenovo server hardware from VMware vCenter or Microsoft System Center
- Deployment of firmware updates and configuration patterns to Lenovo x86 [rack servers](#) and Flex System from the virtualization management tool
- Non-disruptive server maintenance in clustered environments that reduces workload downtime by dynamically migrating workloads from affected hosts during rolling server updates or reboots
- Greater service level uptime and assurance in clustered environments during unplanned hardware events by dynamically triggering workload migration from impacted hosts when impending hardware failures are predicted

For more information about all the available Lenovo XClarity Integrators, see the Lenovo XClarity Administrator Product Guide: <https://lenovopress.com/tips1200-lenovo-xclarity-administrator>

Lenovo XClarity Essentials

Lenovo offers the following XClarity Essentials software tools that can help you set up, use, and maintain the server at no additional cost:

- **Lenovo Essentials OneCLI**
OneCLI is a collection of server management tools that uses a command line interface program to manage firmware, hardware, and operating systems. It provides functions to collect full system health information (including health status), configure system settings, and update system firmware and drivers.
- **Lenovo Essentials UpdateXpress**
The UpdateXpress tool is a standalone GUI application for firmware and device driver updates that enables you to maintain your server firmware and device drivers up-to-date and help you avoid unnecessary server outages. The tool acquires and deploys individual updates and UpdateXpress System Packs (UXSPs) which are integration-tested bundles.
- **Lenovo Essentials Bootable Media Creator**
The Bootable Media Creator (BOMC) tool is used to create bootable media for offline firmware update.

For more information and downloads, visit the Lenovo XClarity Essentials web page: <http://support.lenovo.com/us/en/documents/LNVO-center>

Lenovo XClarity Energy Manager

Lenovo XClarity Energy Manager (LXEM) is a power and temperature management solution for data centers. It is an agent-free, web-based console that enables you to monitor and manage power consumption and temperature in your data center through the management console. It enables server density and data center capacity to be increased through the use of power capping.

LXEM is a licensed product. A single-node LXEM license is included with the XClarity Controller Platinum upgrade as described in the [XCC2 Platinum](#) section. If your server does not have the XCC Platinum upgrade, Energy Manager licenses can be ordered as shown in the following table.

Table 98. Lenovo XClarity Energy Manager

Part number	Description
4L40E51621	Lenovo XClarity Energy Manager Node License (1 license needed per server)

For more information about XClarity Energy Manager, see the following resources:

- Lenovo Support page:
<https://datacentersupport.lenovo.com/us/en/solutions/lvno-lxem>
- User Guide for XClarity Energy Manager:
<https://pubs.lenovo.com/lxem/>

Lenovo Capacity Planner

Lenovo Capacity Planner is a power consumption evaluation tool that enhances data center planning by enabling IT administrators and pre-sales professionals to understand various power characteristics of racks, servers, and other devices. Capacity Planner can dynamically calculate the power consumption, current, British Thermal Unit (BTU), and volt-ampere (VA) rating at the rack level, improving the planning efficiency for large scale deployments.

For more information, refer to the Capacity Planner web page:
<http://datacentersupport.lenovo.com/us/en/solutions/lvno-lcp>

Security

Topics in this section:

- [Security features](#)
- [Platform Firmware Resiliency - Lenovo ThinkShield](#)
- [Security standards](#)

Security features

The SR650 V3 server offers the following electronic security features:

- Secure Boot function of the Intel Xeon processor
- Support for Platform Firmware Resiliency (PFR) hardware Root of Trust (RoT) - see the [Platform Firmware Resiliency](#) section
- Firmware signature processes compliant with FIPS and NIST requirements
- System Guard (part of [XCC Platinum](#)) - Proactive monitoring of hardware inventory for unexpected component changes
- Administrator and power-on password
- Integrated Trusted Platform Module (TPM) supporting TPM 2.0
- Self-encrypting drives (SEDs) with support for enterprise key managers - see the [SED encryption key management](#) section

The server is NIST SP 800-147B compliant.

The SR650 V3 server also offers the following physical security features:

- Optional chassis intrusion switch
- Optional lockable front security bezel

The optional lockable front security bezel is shown in the following figure and includes a key that enables you to secure the bezel over the drives and system controls thereby reducing the chance of unauthorized or accidental access to the server.

Front PCIe slots: The use of the security bezel is not supported when the server has front PCIe slots.



Figure 27. Lockable front security bezel

The dimensions of the security bezel are:

- Width: 437 mm (17.2 in.)
- Height: 87 mm (3.4 in.)
- Width: 23 mm (0.9 in.)

The following table lists the security options for the SR650 V3.

Table 99. Security features

Part number	Feature code	Description
4X97A82927	BAJJ	ThinkSystem SR650 V3/SR655 V3 Intrusion Cable
4XH7A09886	B8M2	ThinkSystem V2 2U Security Bezel Option Kit
4XH7A90300	BXBQ	ThinkSystem V3 2U Security Bezel Option Kit

Tip: The only difference between security bezels 4XH7A09886 and 4XH7A90300 is the Lenovo logo: On 4XH7A09886, the logo is made from plastic; on 4XH7A90300, the logo is made from aluminum alloy.

Platform Firmware Resiliency - Lenovo ThinkShield

Lenovo's ThinkShield Security is a transparent and comprehensive approach to security that extends to all dimensions of our data center products: from development, to supply chain, and through the entire product lifecycle.

The ThinkSystem SR650 V3 includes Platform Firmware Resiliency (PFR) hardware Root of Trust (RoT) which enables the system to be NIST SP800-193 compliant. This offering further enhances key platform subsystem protections against unauthorized firmware updates and corruption, to restore firmware to an integral state, and to closely monitor firmware for possible compromise from cyber-attacks.

PFR operates upon the following server components:

- UEFI image – the low-level server firmware that connects the operating system to the server hardware
- XCC image – the management “engine” software that controls and reports on the server status separate from the server operating system
- FPGA image – the code that runs the server’s lowest level hardware controller on the motherboard

The Lenovo Platform Root of Trust Hardware performs the following three main functions:

- Detection – Measures the firmware and updates for authenticity
- Recovery – Recovers a corrupted image to a known-safe image
- Protection – Monitors the system to ensure the known-good firmware is not maliciously written

These enhanced protection capabilities are implemented using a dedicated, discrete security processor whose implementation has been rigorously validated by leading third-party security firms. Security evaluation results and design details are available for customer review – providing unprecedented transparency and assurance.

The SR650 V3 includes support for Secure Boot, a UEFI firmware security feature developed by the UEFI Consortium that ensures only immutable and signed software are loaded during the boot time. The use of Secure Boot helps prevent malicious code from being loaded and helps prevent attacks, such as the installation of rootkits. Lenovo offers the capability to enable secure boot in the factory, to ensure end-to-end protection. Alternatively, Secure Boot can be left disabled in the factory, allowing the customer to enable it themselves at a later point, if desired.

The following table lists the relevant feature code(s).

Table 100. Secure Boot options

Part number	Feature code	Description	Purpose
CTO only	BPKQ	TPM 2.0 with Secure Boot	Configure the system in the factory with Secure Boot enabled.
CTO only	BPKR	TPM 2.0	Configure the system without Secure Boot enabled. Customers can enable Secure Boot later if desired.

Tip: If Secure Boot is not enabled in the factory, it can be enabled later by the customer. However once Secure Boot is enabled, it cannot be disabled.

Security standards

The SR650 V3 supports the following security standards and capabilities:

- **Industry Standard Security Capabilities**
 - Intel CPU Enablement
 - AES-NI (Advanced Encryption Standard New Instructions)
 - CbT (Converged Boot Guard and Trusted Execution Technology)
 - CET (Control flow Enforcement Technology)
 - Hardware-based side channel attack resilience enhancements
 - MKTME/TME (Multi-Key Total Memory Encryption)
 - SGX (Software Guard eXtensions)
 - SGX-TEM (Trusted Environment Mode)
 - TDX (Trust Domain Extensions)
 - TXT (Trusted eXecution Technology)
 - VT (Virtualization Technology)
 - XD (eXecute Disable)
 - Microsoft Windows Security Enablement
 - Credential Guard
 - Device Guard
 - Host Guardian Service
 - TCG (Trusted Computing Group) TPM (Trusted Platform Module) 2.0
 - UEFI (Unified Extensible Firmware Interface) Forum Secure Boot
- **Hardware Root of Trust and Security**
 - Independent security subsystem providing platform-wide NIST SP800-193 compliant Platform Firmware Resilience (PFR)
 - Management domain RoT supplemented by the Secure Boot features of XCC
- **Platform Security**
 - Boot and run-time firmware integrity monitoring with rollback to known-good firmware (e.g., “self-healing”)
 - Non-volatile storage bus security monitoring and filtering
 - Resilient firmware implementation, such as to detect and defeat unauthorized flash writes or SMM

(System Management Mode) memory incursions

- Patented IPMI KCS channel privileged access authorization (USPTO Patent# 11,256,810)
- Host and management domain authorization, including integration with CyberArk for enterprise password management
- KMIP (Key Management Interoperability Protocol) compliant, including support for IBM SKLM and Thales KeySecure
- Reduced “out of box” attack surface
- Configurable network services
- FIPS 140-3 (in progress) validated cryptography for XCC
- CNSA Suite 1.0 Quantum-resistant cryptography for XCC
- Lenovo System Guard

For more information on platform security, see the paper “How to Harden the Security of your ThinkSystem Server and Management Applications” available from <https://lenovopress.com/lp1260-how-to-harden-the-security-of-your-thinksystem-server>.

- **Standards Compliance and/or Support**

- NIST SP800-131A rev 2 “Transitioning the Use of Cryptographic Algorithms and Key Lengths”
- NIST SP800-147B “BIOS Protection Guidelines for Servers”
- NIST SP800-193 “Platform Firmware Resiliency Guidelines”
- ISO/IEC 11889 “Trusted Platform Module Library”
- Common Criteria TCG Protection Profile for “PC Client Specific TPM 2.0”
- European Union Commission Regulation 2019/424 (“ErP Lot 9”) “Ecodesign Requirements for Servers and Data Storage Products” Secure Data Deletion
- Optional FIPS 140-2 validated Self-Encrypting Disks (SEDs) with external KMIP-based key management

- **Product and Supply Chain Security**

- Suppliers validated through Lenovo’s Trusted Supplier Program
- Developed in accordance with Lenovo’s Secure Development Lifecycle (LSDL)
- Continuous firmware security validation through automated testing, including static code analysis, dynamic network and web vulnerability testing, software composition analysis, and subsystem-specific testing, such as UEFI security configuration validation
- Ongoing security reviews by US-based security experts, with attestation letters available from our third-party security partners
- Digitally signed firmware, stored and built on US-based infrastructure and signed on US-based Hardware Security Modules (HSMs)
- TAA (Trade Agreements Act) compliant manufacturing, by default in Mexico for North American markets with additional US and EU manufacturing options
- US 2019 NDAA (National Defense Authorization Act) Section 889 compliant

Rack installation

The following table lists the rack installation options that are available for the SR650 V3.

Table 101. Rack installation options

Part number	Feature	Description
Rail Kits		
4XF7A99129	C4TL	ThinkSystem Toolless Stab-in Slide Rail Kit V3
4XF7A99131	C4TN	ThinkSystem Toolless Stab-in Slide Rail Kit V3 with 2U CMA
4M17A13564	BK7W	ThinkSystem Toolless Friction Rail v2
4M17A11754	B8LA	ThinkSystem Toolless Slide Rail Kit v2
4M17A11756	B91Y	ThinkSystem Toolless Slide Rail Kit v2 with 2U CMA
Enhanced Rail Kits for > 34 kg server weight*		
4M17A11755	B8LB	ThinkSystem Toolless Slide Rail Kit v2 Enhanced
4M17A11757	B97N	ThinkSystem Toolless Slide Rail Kit v2 Enhanced with 2U CMA
Separate Cable Management Arm		
7M27A05698	B135	ThinkSystem 2U CMA Upgrade Kit for Toolless Slide Rail

* The Enhanced Slide Rail Kits are used when the server is shipped in a rack and the server is 34 kg or heavier (configuration with 20x 3.5-inch HDDs for example)

For the specification of the rail kits, see the ThinkSystem and ThinkEdge Rail Kit Reference:
<https://lenovopress.lenovo.com/lp1838-thinksystem-and-thinkedge-rail-kit-reference#sr650-v3-support=SR650%2520V3>

Operating system support

The SR650 V3 with 5th Gen Intel Xeon Scalable processors supports the following operating systems:

- Microsoft Windows Server 2019
- Microsoft Windows Server 2022
- Red Hat Enterprise Linux 8.8
- Red Hat Enterprise Linux 8.9
- Red Hat Enterprise Linux 8.10
- Red Hat Enterprise Linux 9.2
- Red Hat Enterprise Linux 9.3
- Red Hat Enterprise Linux 9.4
- SUSE Linux Enterprise Server 15 SP5
- SUSE Linux Enterprise Server 15 SP6
- SUSE Linux Enterprise Server 15 Xen SP5
- Ubuntu 20.04 LTS 64-bit
- Ubuntu 22.04 LTS 64-bit
- Ubuntu 24.04 LTS 64-bit
- VMware ESXi 7.0 U3
- VMware ESXi 8.0 U2
- VMware ESXi 8.0 U3
- Windows 10 (x64)
- Windows 11

The SR650 V3 with 4th Gen Intel Xeon Scalable processors supports the following operating systems:

- Microsoft Windows Server 2019
- Microsoft Windows Server 2022
- Red Hat Enterprise Linux 8.6
- Red Hat Enterprise Linux 8.7
- Red Hat Enterprise Linux 8.8

- Red Hat Enterprise Linux 8.9
- Red Hat Enterprise Linux 8.10
- Red Hat Enterprise Linux 9.0
- Red Hat Enterprise Linux 9.1
- Red Hat Enterprise Linux 9.2
- Red Hat Enterprise Linux 9.3
- Red Hat Enterprise Linux 9.4
- SUSE Linux Enterprise Server 15 SP4
- SUSE Linux Enterprise Server 15 SP5
- SUSE Linux Enterprise Server 15 SP6
- SUSE Linux Enterprise Server 15 Xen SP4
- SUSE Linux Enterprise Server 15 Xen SP5
- Ubuntu 20.04 LTS 64-bit
- Ubuntu 22.04 LTS 64-bit
- Ubuntu 24.04 LTS 64-bit
- VMware ESXi 7.0 U3
- VMware ESXi 8.0
- VMware ESXi 8.0 U1
- VMware ESXi 8.0 U2
- VMware ESXi 8.0 U3
- Windows 10 (x64)
- Windows 11

The SR650 V3 also supports VMware vSphere Distributed Services Engine (DSE) with the NVIDIA Bluefield-2 SmartNIC Data Processing Unit (DPU) adapter. See the [DPU adapter](#) section for more information.

For a complete list of supported, certified and tested operating systems, plus additional details and links to relevant web sites, see the Operating System Interoperability Guide:

<https://lenovopress.lenovo.com/osig#servers=sr650-v3-7d75-7d76-7d77>

For configure-to-order configurations, the server can be preloaded with VMware ESXi installed on M.2 cards or 7mm drives. Ordering information is listed in the following table.

Table 102. VMware ESXi preload

Part number	Feature code	Description
CTO only	BMEY	VMware ESXi 7.0 U3 (Factory Installed)
CTO only	BMT5	VMware ESXi 8.0 (Factory Installed)
CTO only	BQ8S	VMware ESXi 8.0 U1 (Factory Installed)
CTO only	BYC7	VMware ESXi 8.0 U2 (Factory Installed)
CTO only	BZ97	VMware ESXi 8.0 U3 (Factory Installed)

Configuration rule:

- An ESXi preload cannot be selected if the configuration includes an NVIDIA GPU (ESXi preload cannot include the NVIDIA driver)

You can download supported VMware vSphere hypervisor images from the following web page and load it on the M.2 drives or 7mm drives using the instructions provided:

https://vmware.lenovo.com/content/custom_iso/

Windows 10 and Windows 11

The SR650 V3 can now run Windows 10 and Windows 11, however only a subset of adapters and drives can be installed. For ease of configuration, additional Base CTO models 7D76CTO3WW and 7D75CTO3WW have been created to assist building a configuration that can be used with the client operating systems. See the [Models](#) section for details.

The XClarity management toolset is supported with Windows 10 and Windows 11.

Windows client license: A Windows client license for the system cannot be ordered from Lenovo nor can the OS be preloaded on the system in the factory. For the Windows license and for preloads, please contact your Lenovo business partner. A Windows Pro license is required as a qualifying base OS license in order to use a client Volume License offering.

See the part number tables in the following sections to see which adapters are supported with Windows 10 and Windows 11:

- [Controllers for internal storage](#)
- [M.2 adapters](#)
- [Network adapters](#)
- [GPU adapters](#)

GPU recommended: Lenovo recommends that if you plan to install Windows 10 or 11 on this server to run graphics-intensive applications, then you should selected a dedicated graphics adapter (GPU).

The following components are not supported:

- Fibre Channel adapters
- InfiniBand and VPI adapters
- External storage adapters
- Flash storage adapters

Physical and electrical specifications

The SR650 V3 has the following overall physical dimensions, excluding components that extend outside the standard chassis, such as EIA flanges, front security bezel (if any), and power supply handles:

- Width: 445 mm (17.5 inches)
- Height: 87 mm (3.4 inches)
- Depth: 766 mm (30.1 inches)

The following table lists the detailed dimensions. See the figure below for the definition of each dimension.

Table 103. Detailed dimensions

Dimension	Description
482 mm	X_a = Width, to the outsides of the front EIA flanges
435 mm	X_b = Width, to the rack rail mating surfaces
445 mm	X_c = Width, to the outer most chassis body feature
87 mm	Y_a = Height, from the bottom of chassis to the top of the chassis
698 mm	Z_a = Depth, from the rack flange mating surface to the rearmost I/O port surface
732 mm	Z_b = Depth, from the rack flange mating surface to the rearmost feature of the chassis body
727 mm ($\leq 1100W$ PSU) 755 mm (1800W PSU) 781 mm (2400W PSU)	Z_c = Depth, from the rack flange mating surface to the rearmost feature such as power supply handle
34 mm	Z_d = Depth, from the forwardmost feature on front of EIA flange to the rack flange mating surface
46 mm	Z_e = Depth, from the front of security bezel (if applicable) or forwardmost feature to the rack flange mating surface

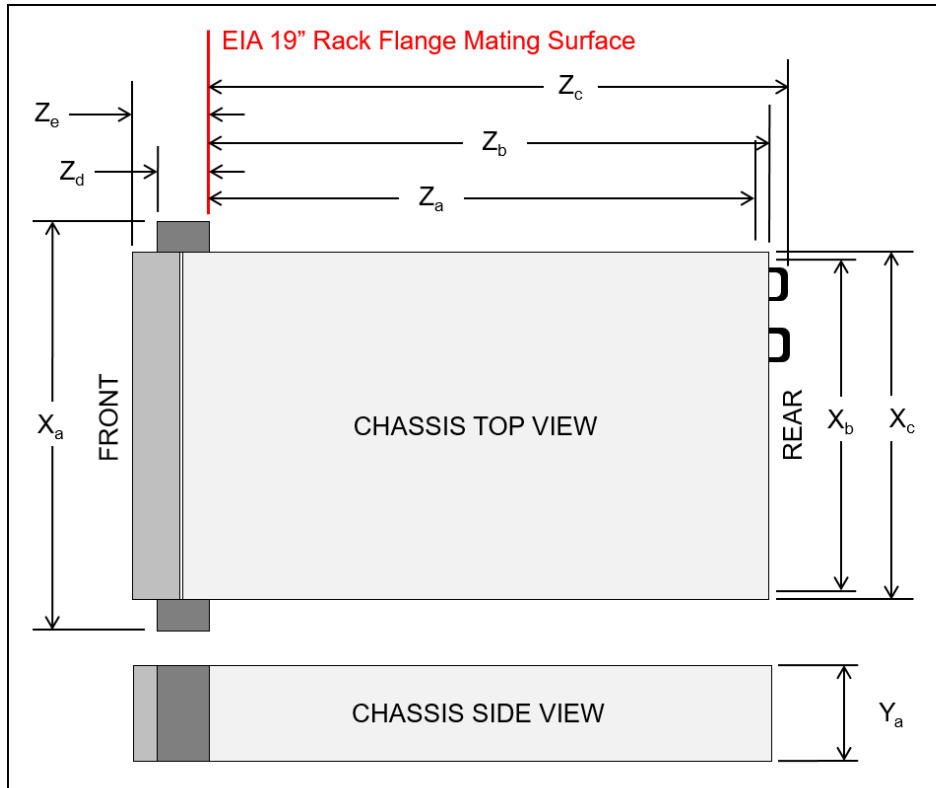

Figure 28. Server dimensions

The shipping (cardboard packaging) dimensions of the SR650 V3 are as follows:

- Width: 592 mm (23.3 inches)
- Height: 282 mm (11.1 inches)
- Depth: 992 mm (39.1 inches)

The server has the following weight:

- Base configuration: 21.4 kg (47.2 lb)
- Maximum weight: 38.8 kg (85.5 lb)

Electrical specifications for AC input power supplies:

- Input voltage:
 - 100 to 127 (nominal) Vac, 50 Hz or 60 Hz
 - 200 to 240 (nominal) Vac, 50 Hz or 60 Hz
 - 180 to 300 Vdc (China only)
- Inlet current: See the following table.

Table 104. Maximum inlet current

Part number	Description	100V AC	200V AC	220V AC	240V DC
AC input power - 80 PLUS Titanium efficiency					
4P57A82019	ThinkSystem 750W 230V Titanium Hot-Swap Gen2 Power Supply v3	No support	4A	3.6A	3.3A
4P57A72666	ThinkSystem 1100W 230V Titanium Hot-Swap Gen2 Power Supply	No support	5.9A	5.3A	5A
4P57A78359	ThinkSystem 1800W 230V Titanium Hot-Swap Gen2 Power Supply	No support	9.7A	8.7A	8.3A
4P57A72667	ThinkSystem 2600W 230V Titanium Hot-Swap Gen2 Power Supply v4	No support	13.2A	13A	11.9A
AC input power - 80 PLUS Platinum efficiency					
4P57A72670	ThinkSystem 750W 230V/115V Platinum Hot-Swap Gen2 Power Supply v3	8.4A	4.1A	3.69A	3.5A
4P57A72671	ThinkSystem 1100W 230V/115V Platinum Hot-Swap Gen2 Power Supply v3	12A	6A	5.4A	5.1A
4P57A78362	ThinkSystem 1800W 230V Platinum Hot-Swap Gen2 Power Supply v2	No support	10A	9.1A	9A
4P57A26295	ThinkSystem 2400W 230V Platinum Hot-Swap Gen2 Power Supply	No support	14A	12.6A	12A

Electrical specifications for DC input power supply:

- Input voltage: -48 to -60 Vdc
- Inlet current (1100W power supply): 26 A

Operating environment

The SR650 V3 server complies with ASHRAE Class A2 specifications with most configurations, and depending on the hardware configuration, also complies with ASHRAE Class A3 and Class A4 specifications.

Depending on the hardware configuration, the SR650 V3 server also complies with ASHRAE Class H1 specification. System performance may be impacted when operating temperature is outside ASHRAE H1 specification.

Topics in this section:

- [Ambient temperature requirements](#)
- [Temperature and humidity](#)
- [Acoustical noise emissions](#)
- [Shock and vibration](#)
- [Particulate contamination](#)

Ambient temperature requirements

The restrictions to ASHRAE support are as follows (cooling by air):

- The ambient temperature must be limited to 35°C or lower if the server has any of the following components:
 - Broadcom 57416 10GBASE-T 2-port OCP
 - Broadcom 57454 10GBASE-T 4-port OCP
 - PCIe network interface card (NIC) at a rate greater than or equal to 100 GB
 - Part with AOC and at the rate of 40 GB

- The ambient temperature must be limited to 30 °C or lower if the server has any of the following components:
 - 24 x 2.5" or 12 x 3.5" front bay with middle bay or rear bay
 - GPU adapters
 - 256 GB 3DS RDIMM
 - 350 W processor
 - part with AOC and at a rate greater than 40 GB
 - 5600 MHz RDIMMs with capacity greater than or equal to 96 GB
 - ThinkSystem 96GB TruDDR5 4800MHz (2Rx4) RDIMM
 - ThinkSystem 128GB TruDDR5 4800MHz (4Rx4) 3DS RDIMM v1
 - 4800 MHz 256 GB RDIMMs (except ThinkSystem 256GB TruDDR5 4800MHz (8Rx4) 3DS RDIMM v1)
- The ambient temperature must be limited to 25 °C or lower if the server has any of the following components or configurations:
 - 350 W processor installed in the chassis with 24 x 2.5" or 12 x 3.5" front drives
 - 350 W processor installed in the 16 x 2.5" + FIO non-GPU configuration
 - processor (270 W <=TDP <= 300 W) installed in the chassis with middle or rear drives
 - GPU adapter installed in the chassis with 24 x 2.5" front drives
 - GPU adapter and processor with TDP rating greater than 300 W installed in the chassis with 16 x 2.5" or 8 x 3.5" front drives
 - drives larger than 3.84 TB installed in Gen 5 rear or middle NVMe drive bays
 - 36 NVMe configuration
 - 16 x 2.5" + FIO GPU configuration
 - ThinkSystem 256GB TruDDR5 4800MHz (8Rx4) 3DS RDIMM v1
 - ThinkSystem 96GB TruDDR5 4800MHz (2Rx4) RDIMM installed in the following configurations:
 - 12 x 3.5" configurations including processors with TDP less than or equal to 300W
 - 12 x 3.5" + middle/rear drive bay configurations including processors with TDP less than or equal to 270W
 - Intel Max 1100 GPU
 - The following NVMe SSDs installed in the front 12 x 3.5" SAS/SATA + middle 8 x 2.5" NVMe or front 12 x 3.5" SAS/SATA + rear 4 x 2.5" NVMe configuration:
 - ThinkSystem 2.5" U.2 P5336 61.44TB Read Intensive NVMe PCIe 4.0 x4 HS SSD
 - ThinkSystem 2.5" U.2 P5336 30.72TB Read Intensive NVMe PCIe 4.0 x4 HS SSD
 - ThinkSystem 2.5" U.2 P5336 15.36TB Read Intensive NVMe PCIe 4.0 x4 HS SSD
 - H100 NVL GPU adapter

The restrictions to ASHRAE support are as follows (cooling by Direct Water Cooling Module (DWCM)):

- The ambient temperature must be limited to 35 °C or lower if the server has any of the following components or configurations:
 - Broadcom 57416 10GBASE-T 2-port OCP
 - Broadcom 57454 10GBASE-T 4-port OCP
 - PCIe network interface card (NIC) at a rate greater than or equal to 100 GB
 - Part with AOC and at the rate of 40 GB
 - GPU adapters (< 300 W) installed in 8 x 3.5" or 16 x 2.5" configurations
 - 64 GB < DIMM < 256 GB
 - 8 x 2.5" GPU configuration
 - storage configuration without middle or rear NVMe backplane
- The ambient temperature must be limited to 30 °C or lower if the server has any of the following components:
 - 256 GB 3DS RDIMM
 - part with AOC and at a rate greater than 40 GB
 - GPU adapters (>= 300 W) installed in 8 x 3.5" or 16 x 2.5" configurations
 - three A40 GPU adapters installed in 24 x 2.5" configurations
 - storage configuration with middle or rear NVMe backplane
 - 5600 MHz RDIMMs with capacity greater than or equal to 96 GB
 - ThinkSystem 96GB TruDDR5 4800MHz (2Rx4) RDIMM
 - ThinkSystem 128GB TruDDR5 4800MHz (4Rx4) 3DS RDIMM v1
 - 4800 MHz 256 GB RDIMMs (except ThinkSystem 256GB TruDDR5 4800MHz (8Rx4) 3DS

- RDIMM v1)
 - H100 NVL GPU adapter
- The ambient temperature must be limited to 25 °C or lower if the server has any of the following components:
 - three H800/H100 GPU adapters installed in 24 x 2.5" configurations
 - three H800/H100 GPU adapters installed in 16 x 2.5" + FIO configurations
 - ThinkSystem 256GB TruDDR5 4800MHz (8Rx4) 3DS RDIMM v1
 - The following NVMe SSDs installed in the front 12 x 3.5" SAS/SATA + middle 8 x 2.5" NVMe or front 12 x 3.5" SAS/SATA + rear 4 x 2.5" NVMe configuration:
 - ThinkSystem 2.5" U.2 P5336 61.44TB Read Intensive NVMe PCIe 4.0 x4 HS SSD
 - ThinkSystem 2.5" U.2 P5336 30.72TB Read Intensive NVMe PCIe 4.0 x4 HS SSD
 - ThinkSystem 2.5" U.2 P5336 15.36TB Read Intensive NVMe PCIe 4.0 x4 HS SSD

Server shutdown: When the ambient temperature is greater than the supported max temperature (ASHARE A4 45°C), the server will shut down. The server will not power on again until the ambient temperature falls within the supported temperature range.

For additional information, see the Environmental specifications and Thermal rules sections in the product documentation:

https://pubs.lenovo.com/sr650-v3/server_specifications_environmental

https://pubs.lenovo.com/sr650-v3/thermal_rules

Temperature and humidity

The server is supported in the following environment:

- Air temperature:
 - Operating:
 - ASHRAE Class A2: 10°C to 35°C (50°F to 95°F); the maximum ambient temperature decreases by 1°C for every 300 m (984 ft) increase in altitude above 900 m (2,953 ft).
 - ASHRAE Class A3: 5°C to 40°C (41°F to 104°F); the maximum ambient temperature decreases by 1°C for every 175 m (574 ft) increase in altitude above 900 m (2,953 ft).
 - ASHRAE Class A4: 5°C to 45°C (41°F to 113°F); the maximum ambient temperature decreases by 1°C for every 125 m (410 ft) increase in altitude above 900 m (2,953 ft).
 - ASHRAE Class H1: 5 °C to 25 °C (41 °F to 77 °F); Decrease the maximum ambient temperature by 1°C for every 500 m (1640 ft) increase in altitude above 900 m (2,953 ft).
 - Server off: 5°C to 45°C (41°F to 113°F)
 - Shipment/storage: -40°C to 60°C (-40°F to 140°F)
- Maximum altitude: 3,050 m (10,000 ft)
- Relative Humidity (non-condensing):
 - Operating
 - ASHRAE Class A2: 8% to 80%; maximum dew point: 21°C (70°F)
 - ASHRAE Class A3: 8% to 85%; maximum dew point: 24°C (75°F)
 - ASHRAE Class A4: 8% to 90%; maximum dew point: 24°C (75°F)
 - ASHRAE Class H1: 8% to 80%; Maximum dew point: 17°C (63°F)
 - Shipment/storage: 8% to 90%

Acoustical noise emissions

The server has the following acoustic noise emissions declaration:

Table 105. Noise emissions

Configuration	Typical	Storage	GPU
Sound power levels ($L_{WA,d}$)	<ul style="list-style-type: none"> • Idling: 5.6 Bel • Operating: 5.6 Bel 	<ul style="list-style-type: none"> • Idling: 7.3 Bel • Operating: 7.3 Bel 	<ul style="list-style-type: none"> • Idling: 7.3 Bel • Operating: 8.9 Bel
Sound pressure level (L_{pAm})	<ul style="list-style-type: none"> • Idling: 41.5 dBA • Operating: 41.5 dBA 	<ul style="list-style-type: none"> • Idling: 60.2 dBA • Operating: 60.2 dBA 	<ul style="list-style-type: none"> • Idling: 60.2 dBA • Operating: 74.1 dBA

Notes:

- These sound levels were measured in controlled acoustical environments according to procedures specified by ISO7779 and are reported in accordance with ISO 9296.
- The declared acoustic sound levels are based on the following configurations, which may change depending on configuration/conditions :
 - Typical configuration: 8x 2.5-inch front drive bays, 6x standard fans, 2x 205 W CPUs, 8x 64 GB RDIMMs, 8x 2.4 TB SAS HDDs, 1x RAID 940-8i, 1x Intel X710-T2L 10GBASE-T 2-port OCP, 2x 750 W PSUs, No GPUs
 - Storage configuration: 12x 3.5-inch front drive bays, 6x high performance fans, 2x 205 W CPUs, 16x 64 GB RDIMMs, 20x 14 TB SAS HDDs, 1x RAID 940-32i, 1x Intel X710-T2L 10GBASE-T 2-port OCP, 2x 1100 W PSUs, No GPUs
 - GPU configuration: 16x 2.5-inch front drive bays, 6x high performance fans, 2x 205 W CPUs, 32x 64 GB RDIMMs, 16x 2.4 TB SAS HDDs, 1 x RAID 940-16i, 1x Intel X710-T2L 10GBASE-T 2-port OCP, 2x 1800 W PSUs, 3x A100 GPUs
- Government regulations (such as those prescribed by OSHA or European Community Directives) may govern noise level exposure in the workplace and may apply to you and your server installation. The actual sound pressure levels in your installation depend upon a variety of factors, including the number of racks in the installation; the size, materials, and configuration of the room; the noise levels from other equipment; the room ambient temperature, and employee's location in relation to the equipment. Further, compliance with such government regulations depends on a variety of additional factors, including the duration of employees' exposure and whether employees wear hearing protection. Lenovo recommends that you consult with qualified experts in this field to determine whether you are in compliance with the applicable regulations.

Shock and vibration

The server has the following vibration and shock limits:

- Vibration:
 - Operating: 0.21 G rms at 5 Hz to 500 Hz for 15 minutes across 3 axes
 - Non-operating: 1.04 G rms at 2 Hz to 200 Hz for 15 minutes across 6 surfaces
- Shock:
 - Operating: 15 G for 3 milliseconds in each direction (positive and negative X, Y, and Z axes)
 - Non-operating:
 - 23 kg - 31 kg: 35 G for 152 in./sec velocity change across 6 surfaces (3x GPU config, 2.5" config)
 - 32 kg - 68 kg: 35 G for 136 in./sec velocity change across 6 surfaces (20x 3.5" HDD config)

Particulate contamination

Airborne particulates (including metal flakes or particles) and reactive gases acting alone or in combination with other environmental factors such as humidity or temperature might damage the system that might cause the system to malfunction or stop working altogether.

The following specifications indicate the limits of particulates that the system can tolerate:

- Reactive gases:
 - The copper reactivity level shall be less than 200 Angstroms per month (Å/month)
 - The silver reactivity level shall be less than 200 Å/month
- Airborne particulates:
 - The room air should be continuously filtered with MERV 8 filters.
 - Air entering a data center should be filtered with MERV 11 or preferably MERV 13 filters.
 - The deliquescent relative humidity of the particulate contamination should be more than 60% RH
 - Environment must be free of zinc whiskers

For additional information, see the Specifications section of the documentation for the server, available from the Lenovo Documents site, <https://pubs.lenovo.com/>

Water infrastructure for the Lenovo Neptune Processor DWC Module

The Lenovo Processor Neptune Core Module is the liquid-based processor cooling offering for the SR650 V3, as described in the [Lenovo Processor Neptune Core Module](#) section.

The open-loop cooling module requires the following water infrastructure components in the rack cabinet and data center:

- Supported 42U or 48U rack cabinet

The 42U or 48U Heavy Duty Rack Cabinet (machine types 7D6D or 7D6E) are supported. Two 0U mounting points are required for the water manifolds, at the rear of the rack cabinet, one either side.

For information about the 42U and 48U Heavy Duty Rack Cabinets, see the product guide: <https://lenovopress.lenovo.com/lp1498-lenovo-heavy-duty-rack-cabinets>
- 38-port water manifold (machine type 7DE6), installed in the rear of the rack cabinet

The manifold provides quick-disconnect couplings that each server in the rack are connected to. Ordering information is in the table below. Note: With a rack full of SR650 V3 servers, only up to 19 of the manifold ports are used.
- Coolant distribution unit (CDU), either in-rack or in-row

In-rack CDUs are installed at the bottom of the rack cabinet. The supported in-rack CDU is as follows:

 - Lenovo Neptune DWC RM100 In-Rack CDU; see the [RM100 In-Rack Coolant Distribution Unit](#) section

In-row CDUs are separate cabinets that are typically installed at the end of a row of rack cabinets. Examples of suitable in-row CDUs include (but not limited to):

 - CoolTera FS400 310KW CDU
 - Vertiv Liebert XDU60 60KW CDU
- Hose kit to connect to the CDU to the manifold

Ordering information is in the table.

The following figure shows the major components of the solution.

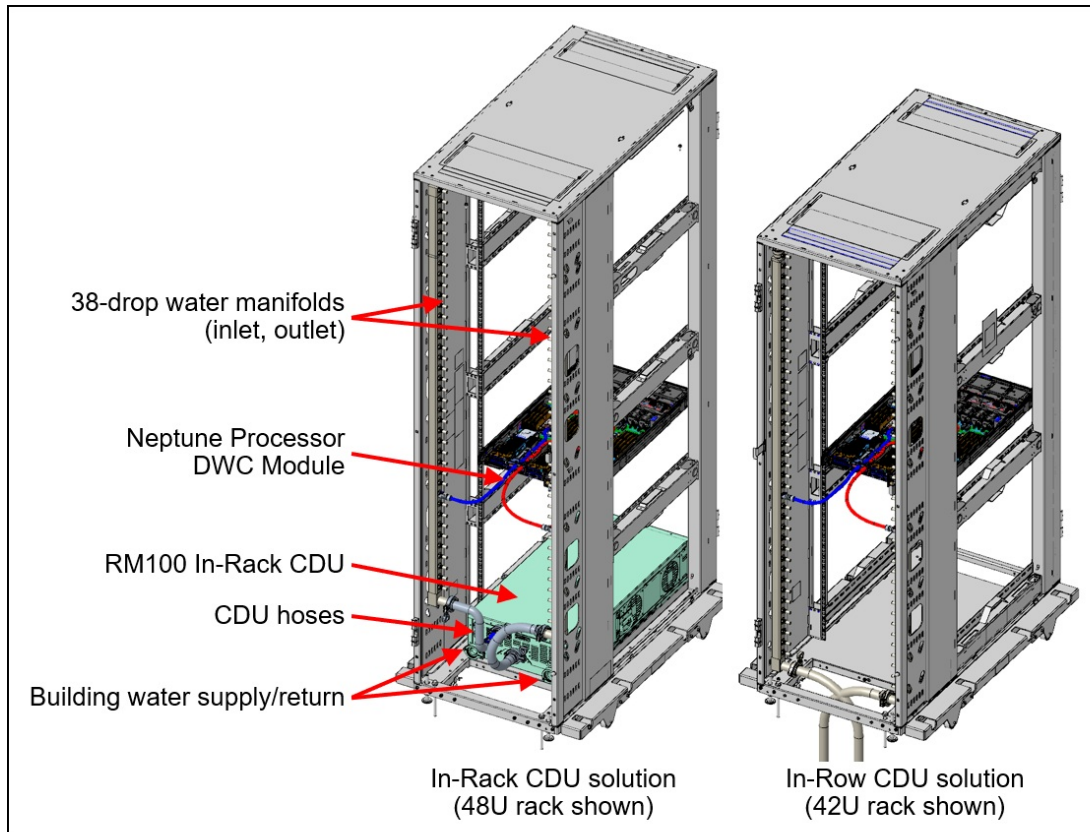

Figure 29. Water manifold connections

Configuration requirements:

- Maximum number of SR650 V3 servers support in a rack:
 - 48U rack: 19 servers
 - 42U rack with in-rack CDU: 18 servers
 - 42U rack without in-rack CDU: 19 servers
- Inlet water flow rate:
 - 0.5 LPM: Maximum 40°C inlet water temperature
 - 1.0 LPM: Maximum 45°C inlet water temperature
 - 1.5 LPM: Maximum 50°C inlet water temperature
- Water pressure requirement:
 - Maximum operating node inlet pressure = 43.5 psi (3 Bar)

The 38-drop water manifold and hoses can be ordered as part numbers or by using the CTO process in the configurators using CTO model 7DE6CTO1WW. The following table lists the ordering information for the water manifold for the Processor Neptune Core Module.

Table 106. Ordering information

Part number	Feature code (7DE6CTO1WW)	Description
Manifold for 42U and 48U rack cabinet		
4XF7A90061	BXHD	ThinkSystem Neptune DWC 38 Port Rack Manifold
Hoses to connect the manifold to an in-rack CDU		
4XF7A90232	BXHE	Connection Set, for 38 Ports Manifold with in-Rack CDU in 42U Rack
4XF7A90233	BXHF	Connection Set, for 38 Ports Manifold with in-Rack CDU in 48U Rack
Hoses to connect the manifold to an in-row CDU		
4XF7A90234	BXHG	Hose Set, 1 inch EPDM, 1.3m, for 38 Ports manifold for in-row CDU
4XF7A90235	BXHH	Hose Set, 1 inch EPDM, 2.3m, for 38 Ports manifold for in-row CDU

Configuration notes:

- This water connection solution described here cannot be used with the DW612S enclosure as the water requirements are different.
- The hoses for in-row CDUs that are listed in the table above have Eaton FD83 quick-disconnect couplings

RM100 In-Rack Coolant Distribution Unit

The RM100 In-Rack Coolant Distribution Unit (CDU) can provide 100kW cooling capacity within the rack cabinet. It is designed as a 4U high rack device installed at the bottom of the rack. The CDU is supported in the 42U and 48U Heavy Duty Rack Cabinets.

For information about the 42U and 48U Heavy Duty Rack Cabinets, see the product guide:

<https://lenovopress.lenovo.com/lp1498-lenovo-heavy-duty-rack-cabinets>

The following figure shows the RM100 CDU.



Figure 30. RM100 In-Rack Coolant Distribution Unit

The CDU can be ordered using the CTO process in the configurators using machine type 7DBL. The following table lists the base CTO model and base feature code.

Table 107. Ordering information

CTO model	Base feature	Description
7DBLCTOLWW	BRL4	Lenovo Neptune DWC RM100 In-Rack CDU

For details and exact specification of the CDU, see the In-Rack CDU Operation & Maintenance Guide:

https://pubs.lenovo.com/hdc_rackcabinet/rm100_user_guide.pdf

Professional Services: The factory integration of the In-Rack CDU requires Lenovo Professional Services review and approval for warranty and associated extended services. Before ordering CDU and manifold, contact the Lenovo Professional Services team (CDUsupport@lenovo.com).

Warranty upgrades and post-warranty support

The SR650 V3 has a 1-year or 3-year warranty based on the machine type of the system:

- 7D75 - 1 year warranty
- 7D76 - 3 year warranty
- 7D77 - 3 year warranty

Our global network of regional support centers offers consistent, local-language support enabling you to vary response times and level of service to match the criticality of your support needs:

- **Standard Next Business Day** – Best choice for non-essential systems requiring simple maintenance.
- **Premier Next Business Day** – Best choice for essential systems requiring technical expertise from senior-level Lenovo engineers.
- **Premier 24x7 4-Hour Response** – Best choice for systems where maximum uptime is critical.
- **Premier Enhanced Storage Support 24x7 4-Hour Response** – Best choice for storage systems where maximum uptime is critical.

For more information, consult the brochure [Lenovo Operational Support Services for Data Centers Services](#).

Services

Lenovo Data Center Services empower you at every stage of your IT lifecycle. From expert advisory and strategic planning to seamless deployment and ongoing support, we ensure your infrastructure is built for success. Our comprehensive services accelerate time to value, minimize downtime, and free your IT staff to focus on driving innovation and business growth.

Note: Some service options may not be available in all markets or regions. For more information, go to <https://lenovocator.com/>. For information about Lenovo service upgrade offerings that are available in your region, contact your local Lenovo sales representative or business partner.

In this section:

- [Lenovo Advisory Services](#)
- [Lenovo Plan & Design Services](#)
- [Lenovo Deployment, Migration, and Configuration Services](#)
- [Lenovo Support Services](#)
- [Lenovo Managed Services](#)
- [Lenovo Sustainability Services](#)

Lenovo Advisory Services

Lenovo Advisory Services simplify the planning process, enabling customers to build future-proofed strategies in as little as six weeks. Consultants provide guidance on projects including VM migration, storage, backup and recovery, and cost management to accelerate time to value, improve cost efficiency, and build a flexibly scalable foundation.

- **Assessment Services**

An Assessment helps solve your IT challenges through an onsite, multi-day session with a Lenovo technology expert. We perform a tools-based assessment which provides a comprehensive and thorough review of a company's environment and technology systems. In addition to the technology based functional requirements, the consultant also discusses and records the non-functional business requirements, challenges, and constraints. Assessments help organizations like yours, no matter how large or small, get a better return on your IT investment and overcome challenges in the ever-changing technology landscape.

- **Design Services**

Professional Services consultants perform infrastructure design and implementation planning to support your strategy. The high-level architectures provided by the assessment service are turned into low level designs and wiring diagrams, which are reviewed and approved prior to implementation. The implementation plan will demonstrate an outcome-based proposal to provide business capabilities through infrastructure with a risk-mitigated project plan.

Lenovo Plan & Design Services

Unlock faster time to market with our tailored, strategic design workshops to align solution approaches with your business goals and technical requirements. Leverage our deep solution expertise and end-to-end delivery partnership to meet your goals efficiently and effectively.

Lenovo Deployment, Migration, and Configuration Services

Optimize your IT operations by shifting labor-intensive functions to Lenovo's skilled technicians for seamless on-site or remote deployment, configuration, and migration. Enjoy peace of mind, faster time to value, and comprehensive knowledge sharing with your IT staff, backed by our best-practice methodology.

- **Deployment Services for Storage and ThinkAgile**

A comprehensive range of remote and onsite options tailored specifically for your business needs to ensure your storage and ThinkAgile hardware are fully operational from the start.

- **Hardware Installation Services**

A full-range, comprehensive setup for your hardware, including unpacking, inspecting, and positioning components to ensure your equipment is operational and error-free for the most seamless and efficient installation experience, so you can quickly benefit from your investments.

- **DM/DG File Migration Services**

Take the burden of file migration from your IT's shoulders. Our experts will align your requirements and business objectives to the migration plans while coordinating with your team to plan and safely execute the data migration to your storage platforms.

- **DM/DG/DE Health Check Services**

Our experts perform proactive checks of your Firmware and system health to ensure your machines are operating at peak and optimal efficiency to maximize up-time, avoid system failures, ensure the security of IT solutions and simplify maintenance.

- **Factory Integrated Services**

A suite of value-added offerings provided during the manufacturing phase of a server or storage system that reduces time to value. These services aim at improving your hardware deployment experience and enhance the quality of a standard configuration before it arrives at your facility.

Lenovo Support Services

In addition to response time options for hardware parts, repairs, and labor, Lenovo offers a wide array of additional support services to ensure your business is positioned for success and longevity. Our goal is to reduce your capital outlays, mitigate your IT risks, and accelerate your time to productivity.

- **Premier Support for Data Centers**

Your direct line to the solution that promises the best, most comprehensive level of support to help you fully unlock the potential of your data center.

- **Premier Enhanced Storage Support (PESS)**

Gain all the benefits of Premier Support for Data Centers, adding dedicated storage specialists and resources to elevate your storage support experience to the next level.

- **Committed Service Repair (CSR)**

Our commitment to ensuring the fastest, most seamless resolution times for mission-critical systems that require immediate attention to ensure minimal downtime and risk for your business. This service is only available for machines under the Premier 4-Hour Response SLA.

- **Multivendor Support Services (MVS)**

Your single point of accountability for resolution support across vast range of leading Server, Storage, and Networking OEMs, allowing you to manage all your supported infrastructure devices seamlessly from a single source.

- **Keep Your Drive (KYD)**

Protect sensitive data and maintain compliance with corporate retention and disposal policies to ensure your data is always under your control, regardless of the number of drives that are installed in your Lenovo server.

- **Technical Account Manager (TAM)**

Your single point of contact to expedite service requests, provide status updates, and furnish reports to track incidents over time, ensuring smooth operations and optimized performance as your business grows.

- **Enterprise Software Support (ESS)**

Gain comprehensive, single-source, and global support for a wide range of server operating systems and Microsoft server applications.

For more information, consult the brochure [Lenovo Operational Support Services for Data Centers](#).

Lenovo Managed Services

Achieve peak efficiency, high security, and minimal disruption with Lenovo's always-on Managed Services. Our real-time monitoring, 24x7 incident response, and problem resolution ensure your infrastructure operates seamlessly. With quarterly health checks for ongoing optimization and innovation, Lenovo's remote active monitoring boosts end-user experience and productivity by keeping your data center's hardware performing at its best.

Lenovo Managed Services provides continuous 24x7 remote monitoring (plus 24x7 call center availability) and proactive management of your data center using state-of-the-art tools, systems, and practices by a team of highly skilled and experienced Lenovo services professionals.

Quarterly reviews check error logs, verify firmware & OS device driver levels, and software as needed. We'll also maintain records of latest patches, critical updates, and firmware levels, to ensure you systems are providing business value through optimized performance.

Lenovo Sustainability Services

- **Asset Recovery Services**

Lenovo Asset Recovery Services (ARS) provides a secure, seamless solution for managing end-of-life IT assets, ensuring data is safely sanitized while contributing to a more circular IT lifecycle. By maximizing the reuse or responsible recycling of devices, ARS helps businesses meet sustainability goals while recovering potential value from their retired equipment. For more information, see the [Asset Recovery Services offering page](#).

- **CO2 Offset Services**

Lenovo's CO2 Offset Services offer a simple and transparent way for businesses to take tangible action on their IT footprint. By integrating CO2 offsets directly into device purchases, customers can easily support verified climate projects and track their contributions, making meaningful progress toward their sustainability goals without added complexity.

- **Lenovo Certified Refurbished**

Lenovo Certified Refurbished offers a cost-effective way to support IT circularity without compromising on quality and performance. Each device undergoes rigorous testing and certification, ensuring reliable performance and extending its lifecycle. With Lenovo's trusted certification, you gain peace of mind while making a more sustainable IT choice.

Lenovo TruScale

Lenovo TruScale XaaS is your set of flexible IT services that makes everything easier. Streamline IT procurement, simplify infrastructure and device management, and pay only for what you use – so your business is free to grow and go anywhere.

Lenovo TruScale is the unified solution that gives you simplified access to:

- The industry's broadest portfolio – from pocket to cloud – all delivered as a service
- A single-contract framework for full visibility and accountability
- The global scale to rapidly and securely build teams from anywhere
- Flexible fixed and metered pay-as-you-go models with minimal upfront cost
- The growth-driving combination of hardware, software, infrastructure, and solutions – all from one single provider with one point of accountability.

For information about Lenovo TruScale offerings that are available in your region, contact your local Lenovo sales representative or business partner.

Regulatory compliance

The SR650 V3 conforms to the following standards:

- ANSI/UL 62368-1
- IEC 62368-1 (CB Certificate and CB Test Report)
- CSA C22.2 No. 62368-1
- Mexico NOM-019
- India BIS 13252 (Part 1)
- Germany GS
- TUV-GS (EN62368-1, and EK1-ITB2000)
- Brazil INMETRO
- South Africa NRCS LOA
- Ukraine UkrCEPRO
- Morocco CMIM Certification (CM)
- Russia, Belorussia and Kazakhstan, TP EAC 037/2016 (for RoHS)
- Russia, Belorussia and Kazakhstan, EAC: TP TC 004/2011 (for Safety); TP TC 020/2011 (for EMC)
- CE, UKCA Mark (EN55032 Class A, EN62368-1, EN55024, EN55035, EN61000-3-2, EN61000-3-3, (EU) 2019/424, and EN IEC 63000 (RoHS))
- CE, UKCA Mark (EN55032 Class A, EN62368-1, EN55035, EN61000-3-11, EN61000-3-12, (EU) 2019/424, and EN IEC 63000 (RoHS))
- FCC - Verified to comply with Part 15 of the FCC Rules, Class A
- Canada ICES-003, issue 7, Class A
- CISPR 32, Class A, CISPR 35
- Korea KN32, Class A, KN35
- Japan VCCI, Class A
- Taiwan BSMI CNS15936, Class A; CNS15598-1; Section 5 of CNS15663
- Australia/New Zealand AS/NZS CISPR 32, Class A; AS/NZS 62368.1
- UL Green Guard, UL2819
- [Energy Star 4.0](#)
- EPEAT (NSF/ ANSI 426) Bronze
- Japanese Energy-Saving Act
- EU2019/424 Energy Related Product (ErP Lot9)
- China CCC certificate, GB17625.1; GB4943.1; GB/T9254
- China CECP certificate, CQC3135
- China CELP certificate, HJ 2507-2011

External drive enclosures

The server supports attachment to external drive enclosures using a RAID controller with external ports or a SAS host bus adapter. Adapters supported by the server are listed in the [SAS adapters for external storage](#) section.

Note: Information provided in this section is for ordering reference purposes only. For the operating system and adapter support details, refer to the interoperability matrix for a particular storage enclosure that can be found on the Lenovo Data Center Support web site:

<http://datacentersupport.lenovo.com>

Table 108. External drive enclosures

Model	Description
4587HC1	Lenovo Storage D1212 Disk Expansion Enclosure (2U enclosure with 12x LFF drive bays)
4587HC2	Lenovo Storage D1224 Disk Expansion Enclosure (2U enclosure with 24x SFF drive bays)
6413HC1	Lenovo Storage D3284 High Density Expansion Enclosure (5U enclosure with 84x LFF drive bays)
7DAHCTO1WW	Lenovo ThinkSystem D4390 Direct Attached Storage (4U enclosure with 90x LFF drive bays)

For details about supported drives, adapters, and cables, see the following Lenovo Press Product Guides:

- Lenovo Storage D1212 and D1224
<http://lenovopress.lenovo.com/lp0512>
- Lenovo Storage D3284
<http://lenovopress.lenovo.com/lp0513>
- Lenovo ThinkSystem D4390
<https://lenovopress.lenovo.com/lp1681>

External storage systems

Lenovo offers the ThinkSystem DE Series and ThinkSystem DM Series external storage systems for high-performance storage. See the DE Series and DM Series product guides for specific controller models, expansion enclosures and configuration options:

- ThinkSystem DE Series Storage
<https://lenovopress.com/storage/thinksystem/de-series#rt=product-guide>
- ThinkSystem DM Series Storage
<https://lenovopress.com/storage/thinksystem/dm-series#rt=product-guide>
- ThinkSystem DG Series Storage
<https://lenovopress.com/storage/thinksystem/dg-series#rt=product-guide>

External backup units

The following table lists the external backup options that are offered by Lenovo.

Table 109. External backup options

Part number	Description
External RDX USB drives	
4T27A10725	ThinkSystem RDX External USB 3.0 Dock
External SAS tape backup drives	
6160S7E	IBM TS2270 Tape Drive Model H7S
6160S8E	IBM TS2280 Tape Drive Model H8S
6160S9E	IBM TS2290 Tape Drive Model H9S
External SAS tape backup autoloaders	
6171S7R	IBM TS2900 Tape Autoloader w/LTO7 HH SAS
6171S8R	IBM TS2900 Tape Autoloader w/LTO8 HH SAS
6171S9R	IBM TS2900 Tape Autoloader w/LTO9 HH SAS
External tape backup libraries	
6741A1F	IBM TS4300 3U Tape Library-Base Unit
6741A3F	IBM TS4300 3U Tape Library-Expansion Unit
Full High 8 Gb Fibre Channel for TS4300	
01KP938	LTO 7 FH Fibre Channel Drive
01KP954	LTO 8 FH Fibre Channel Drive
02JH837	LTO 9 FH Fibre Channel Drive
Half High 8 Gb Fibre Channel for TS4300	
01KP936	LTO 7 HH Fibre Channel Drive
01KP952	LTO 8 HH Fibre Channel Drive
02JH835	LTO 9 HH Fibre Channel Drive
Half High 6 Gb SAS for TS4300	
01KP937	LTO 7 HH SAS Drive
01KP953	LTO 8 HH SAS Drive
02JH836	LTO 9 HH SAS Drive

For more information, see the list of Product Guides in the Backup units category:

<https://lenovopress.com/servers/options/backup>

Fibre Channel SAN switches

Lenovo offers the ThinkSystem DB Series of Fibre Channel SAN switches for high-performance storage expansion. See the DB Series product guides for models and configuration options:

- ThinkSystem DB Series SAN Switches:
<https://lenovopress.com/storage/switches/rack#rt=product-guide>

Uninterruptible power supply units

The following table lists the uninterruptible power supply (UPS) units that are offered by Lenovo.

Table 110. Uninterruptible power supply units

Part number	Description
Rack-mounted or tower UPS units - 100-125VAC	
7DD5A001WW	RT1.5kVA 2U Rack or Tower UPS-G2 (100-125VAC)
7DD5A003WW	RT3kVA 2U Rack or Tower UPS-G2 (100-125VAC)
Rack-mounted or tower UPS units - 200-240VAC	
7DD5A002WW	RT1.5kVA 2U Rack or Tower UPS-G2 (200-240VAC)
7DD5A005WW	RT3kVA 2U Rack or Tower UPS-G2 (200-240VAC)
7DD5A007WW	RT5kVA 3U Rack or Tower UPS-G2 (200-240VAC)
7DD5A008WW	RT6kVA 3U Rack or Tower UPS-G2 (200-240VAC)
7DD5A00AWW	RT11kVA 6U Rack or Tower UPS-G2 (200-240VAC)

† Only available in China and the Asia Pacific market.

For more information, see the list of Product Guides in the UPS category:
<https://lenovopress.com/servers/options/ups>

Power distribution units

The following table lists the power distribution units (PDUs) that are offered by Lenovo.

Table 111. Power distribution units

Part number	Feature code	Description	ANZ	ASEAN	Brazil	EET	MEA	RUCIS	WE	HTK	INDIA	JAPAN	LA	NA	PRC
0U Basic PDUs															
4PU7A93176	C0QH	0U 36 C13 and 6 C19 Basic 32A 1 Phase PDU v2	Y	Y	Y	Y	Y	Y	Y	Y	Y	N	Y	Y	Y
4PU7A93169	C0DA	0U 36 C13 and 6 C19 Basic 32A 1 Phase PDU	Y	Y	Y	Y	Y	Y	Y	Y	Y	N	Y	Y	Y
4PU7A93177	C0QJ	0U 24 C13/C15 and 24 C13/C15/C19 Basic 32A 3 Phase WYE PDU v2	Y	Y	Y	Y	Y	Y	Y	Y	Y	Y	Y	Y	Y
4PU7A93170	C0D9	0U 24 C13/C15 and 24 C13/C15/C19 Basic 32A 3 Phase WYE PDU	Y	Y	Y	Y	Y	Y	Y	Y	Y	N	Y	Y	Y
0U Switched and Monitored PDUs															
4PU7A93181	C0QN	0U 21 C13/C15 and 21 C13/C15/C19 Switched and Monitored 48A 3 Phase Delta PDU v2 (60A derated)	N	Y	N	N	N	N	N	Y	N	Y	N	Y	N
4PU7A93174	C0D5	0U 21 C13/C15 and 21 C13/C15/C19 Switched and Monitored 48A 3 Phase Delta PDU (60A derated)	N	Y	N	Y	N	N	Y	Y	N	N	N	Y	N
4PU7A93178	C0QK	0U 20 C13 and 4 C19 Switched and Monitored 32A 1 Phase PDU v2	Y	Y	Y	Y	Y	Y	Y	Y	Y	N	Y	Y	Y
4PU7A93171	C0D8	0U 20 C13 and 4 C19 Switched and Monitored 32A 1 Phase PDU	Y	Y	Y	Y	Y	Y	Y	Y	Y	N	Y	Y	Y
4PU7A93182	C0QP	0U 18 C13/C15 and 18 C13/C15/C19 Switched and Monitored 63A 3 Phase WYE PDU v2	Y	Y	Y	Y	Y	Y	Y	Y	Y	Y	Y	Y	Y
4PU7A93175	C0CS	0U 18 C13/C15 and 18 C13/C15/C19 Switched and Monitored 63A 3 Phase WYE PDU	Y	Y	Y	Y	Y	Y	Y	Y	Y	N	Y	Y	Y
4PU7A93180	C0QM	0U 18 C13/C15 and 18 C13/C15/C19 Switched and Monitored 32A 3 Phase WYE PDU v2	Y	Y	Y	Y	Y	Y	Y	Y	Y	Y	Y	Y	Y
4PU7A93173	C0D6	0U 18 C13/C15 and 18 C13/C15/C19 Switched and Monitored 32A 3 Phase WYE PDU	Y	Y	Y	Y	Y	Y	Y	Y	Y	N	Y	Y	Y
4PU7A93179	C0QL	0U 16 C13/C15 and 16 C13/C15/C19 Switched and Monitored 24A 1 Phase PDU v2 (30A derated)	N	Y	N	N	N	N	N	Y	N	Y	N	Y	N
4PU7A93172	C0D7	0U 16 C13/C15 and 16 C13/C15/C19 Switched and Monitored 24A 1 Phase PDU(30A derated)	N	Y	N	Y	N	N	Y	Y	N	N	N	Y	N
1U Switched and Monitored PDUs															
4PU7A90808	C0D4	1U 18 C19/C13 Switched and monitored 48A 3P WYE PDU V2 ETL	Y	Y	Y	Y	Y	Y	Y	Y	Y	Y	Y	Y	Y
4PU7A81117	BNDV	1U 18 C19/C13 switched and monitored 48A 3P WYE PDU - ETL	N	N	N	N	N	N	N	N	N	N	N	Y	N
4PU7A90809	C0DE	1U 18 C19/C13 Switched and monitored 48A 3P WYE PDU V2 CE	N	N	N	N	N	Y	Y	N	N	N	N	N	N
4PU7A81118	BNDW	1U 18 C19/C13 switched and monitored 48A 3P WYE PDU - CE	Y	Y	Y	Y	Y	Y	Y	Y	Y	N	Y	N	Y
4PU7A90810	C0DD	1U 18 C19/C13 Switched and monitored 80A 3P Delta PDU V2	Y	Y	Y	Y	Y	Y	Y	Y	Y	Y	Y	Y	Y

Part number	Feature code	Description	ANZ	ASEAN	Brazil	EET	MEA	RUCIS	WE	HTK	INDIA	JAPAN	LA	NA	PRC
4PU7A77467	BLC4	1U 18 C19/C13 Switched and Monitored 80A 3P Delta PDU	N	N	N	N	N	N	N	N	N	Y	N	Y	N
4PU7A90811	C0DC	1U 12 C19/C13 Switched and monitored 32A 3P WYE PDU V2	N	N	N	N	N	Y	Y	N	N	N	N	N	N
4PU7A77468	BLC5	1U 12 C19/C13 switched and monitored 32A 3P WYE PDU	Y	Y	Y	Y	Y	Y	Y	Y	Y	Y	Y	Y	Y
4PU7A90812	C0DB	1U 12 C19/C13 Switched and monitored 60A 3P Delta PDU V2	N	N	N	N	N	N	N	N	N	Y	N	N	N
4PU7A77469	BLC6	1U 12 C19/C13 switched and monitored 60A 3P Delta PDU	N	N	N	N	N	N	N	N	N	N	N	Y	N
1U Ultra Density Enterprise PDUs (9x IEC 320 C13 + 3x IEC 320 C19 outlets)															
71763NU	6051	Ultra Density Enterprise C19/C13 PDU 60A/208V/3PH	N	N	Y	N	N	N	N	N	N	Y	Y	Y	N
71762NX	6091	Ultra Density Enterprise C19/C13 PDU Module	Y	Y	Y	Y	Y	Y	Y	Y	Y	Y	Y	Y	Y
1U C13 Enterprise PDUs (12x IEC 320 C13 outlets)															
39Y8941	6010	DPI C13 Enterprise PDU Module (WW)	Y	Y	Y	Y	Y	Y	Y	Y	Y	Y	Y	Y	Y
1U Front-end PDUs (3x IEC 320 C19 outlets)															
39Y8938	6002	DPI Single-phase 30A/120V Front-end PDU (US)	Y	Y	Y	Y	Y	Y	Y	Y	Y	Y	Y	Y	Y
39Y8939	6003	DPI Single-phase 30A/208V Front-end PDU (US)	Y	Y	Y	Y	Y	Y	Y	Y	Y	Y	Y	Y	Y
39Y8934	6005	DPI Single-phase 32A/230V Front-end PDU (International)	Y	Y	Y	Y	Y	Y	Y	Y	Y	Y	Y	Y	Y
39Y8940	6004	DPI Single-phase 60A/208V Front-end PDU (US)	Y	N	Y	Y	Y	Y	Y	N	N	Y	Y	Y	N
39Y8935	6006	DPI Single-phase 63A/230V Front-end PDU (International)	Y	Y	Y	Y	Y	Y	Y	Y	Y	Y	Y	Y	Y
1U NEMA PDUs (6x NEMA 5-15R outlets)															
39Y8905	5900	DPI 100-127V NEMA PDU	Y	Y	Y	Y	Y	Y	Y	Y	Y	Y	Y	Y	Y
Line cords for 1U PDUs that ship without a line cord															
40K9611	6504	4.3m, 32A/380-415V, EPDU/IEC 309 3P+N+G 3ph wye (non-US) Line Cord	Y	Y	Y	Y	Y	Y	Y	Y	Y	Y	Y	Y	Y
40K9612	6502	4.3m, 32A/230V, EPDU to IEC 309 P+N+G (non-US) Line Cord	Y	Y	Y	Y	Y	Y	Y	Y	Y	Y	Y	Y	Y
40K9613	6503	4.3m, 63A/230V, EPDU to IEC 309 P+N+G (non-US) Line Cord	Y	Y	Y	Y	Y	Y	Y	Y	Y	Y	Y	Y	Y
40K9614	6500	4.3m, 30A/208V, EPDU to NEMA L6-30P (US) Line Cord	Y	Y	Y	Y	Y	Y	Y	Y	Y	Y	Y	Y	Y
40K9615	6501	4.3m, 60A/208V, EPDU to IEC 309 2P+G (US) Line Cord	N	N	Y	N	N	N	Y	N	N	Y	Y	Y	N
40K9617	6505	4.3m, 32A/230V, Souriau UTG Female to AS/NZ 3112 (Aus/NZ) Line Cord	Y	Y	Y	Y	Y	Y	Y	Y	Y	Y	Y	Y	Y
40K9618	6506	4.3m, 32A/250V, Souriau UTG Female to KSC 8305 (S. Korea) Line Cord	Y	Y	Y	Y	Y	Y	Y	Y	Y	Y	Y	Y	Y

For more information, see the Lenovo Press documents in the PDU category:
<https://lenovopress.com/servers/options/pdu>

Rack cabinets

The following table lists the supported rack cabinets.

Table 112. Rack cabinets

Model	Description
7D2NCTO1WW	12U 1200mm Deep Micro Datacenter Rack
93072RX	25U Standard Rack (1000mm)
93072PX	25U Static S2 Standard Rack (1000mm)
7D6DA007WW	ThinkSystem 42U Onyx Primary Heavy Duty Rack Cabinet (1200mm)
7D6DA008WW	ThinkSystem 42U Pearl Primary Heavy Duty Rack Cabinet (1200mm)
7D6EA009WW	ThinkSystem 48U Onyx Primary Heavy Duty Rack Cabinet (1200mm)
7D6EA00AWW	ThinkSystem 48U Pearl Primary Heavy Duty Rack Cabinet (1200mm)
1410O42	Lenovo EveryScale 42U Onyx Heavy Duty Rack Cabinet
1410P42	Lenovo EveryScale 42U Pearl Heavy Duty Rack Cabinet
1410O48	Lenovo EveryScale 48U Onyx Heavy Duty Rack Cabinet
1410P48	Lenovo EveryScale 48U Pearl Heavy Duty Rack Cabinet
93604PX	42U 1200mm Deep Dynamic Rack
93614PX	42U 1200mm Deep Static Rack
93634PX	42U 1100mm Dynamic Rack
93634EX	42U 1100mm Dynamic Expansion Rack
93074RX	42U Standard Rack (1000mm)

For specifications about these racks, see the Lenovo Rack Cabinet Reference, available from:
<https://lenovopress.com/lp1287-lenovo-rack-cabinet-reference>

For more information, see the list of Product Guides in the Rack cabinets category:
<https://lenovopress.com/servers/options/racks>

KVM console options

The following table lists the supported KVM consoles.

Table 113. KVM console

Part number	Description
4XF7A84188	ThinkSystem 18.5" LCD Console (with US English keyboard)

The following table lists the available KVM switches and the options that are supported with them.

Table 115. KVM switches and options

Part number	Description
KVM Console switches	
1754D1X	Global 2x2x16 Console Manager (GCM16)
1754A2X	Local 2x16 Console Manager (LCM16)
1754A1X	Local 1x8 Console Manager (LCM8)
Cables for GCM and LCM Console switches	
46M5383	Virtual Media Conversion Option Gen2 (VCO2)
46M5382	Serial Conversion Option (SCO)

For more information, see the list of Product Guides in the KVM Switches and Consoles category:

<http://lenovopress.com/servers/options/kvm>

Lenovo Financial Services

Why wait to obtain the technology you need now? No payments for 90 days and predictable, low monthly payments make it easy to budget for your Lenovo solution.

- **Flexible**

Our in-depth knowledge of the products, services and various market segments allows us to offer greater flexibility in structures, documentation and end of lease options.

- **100% Solution Financing**

Financing your entire solution including hardware, software, and services, ensures more predictability in your project planning with fixed, manageable payments and low monthly payments.

- **Device as a Service (DaaS)**

Leverage latest technology to advance your business. Customized solutions aligned to your needs. Flexibility to add equipment to support growth. Protect your technology with Lenovo's Premier Support service.

- **24/7 Asset management**

Manage your financed solutions with electronic access to your lease documents, payment histories, invoices and asset information.

- **Fair Market Value (FMV) and \$1 Purchase Option Leases**

Maximize your purchasing power with our lowest cost option. An FMV lease offers lower monthly payments than loans or lease-to-own financing. Think of an FMV lease as a rental. You have the flexibility at the end of the lease term to return the equipment, continue leasing it, or purchase it for the fair market value. In a \$1 Out Purchase Option lease, you own the equipment. It is a good option when you are confident you will use the equipment for an extended period beyond the finance term. Both lease types have merits depending on your needs. We can help you determine which option will best meet your technological and budgetary goals.

Ask your Lenovo Financial Services representative about this promotion and how to submit a credit application. For the majority of credit applicants, we have enough information to deliver an instant decision and send a notification within minutes.

Seller training courses

The following sales training courses are offered for employees and partners (login required). Courses are listed in date order.

1. **ThinkSystem Rack and Tower Introduction for ISO Client Managers**

2024-10-31 | 20 minutes | Employees Only

Course Description:

In this course, you will learn about Lenovo's Data Center Portfolio, its ThinkSystem Family and the key features of the Rack and Tower servers. It will equip you with foundational knowledge which you can then expand upon by participating in the facilitated session of the curriculum.

Course Objectives:

By the end of this course, you should be able to:

- Identify Lenovo's main data center brands.
- Describe the key components of the ThinkSystem Family servers.
- Differentiate between the Rack and Tower servers of the ThinkSystem Family.
- Understand the value Rack and Tower servers can provide to customers.

Published: 2024-10-31

Length: 20 minutes

Start the training:

Employee link: Grow@Lenovo

Course code: DSRT0101

2. **Virtual Facilitated Session - ThinkSystem Rack and Tower Primer for ISO Client Managers**

2024-10-31 | 90 minutes | Employees Only

In this instructor-led Virtual Facilitated Session, ISO Client Managers will be able to build on the knowledge gained in Module 1 (eLearning) of the ThinkSystem Rack and Tower Primer for ISO Client Managers curriculum.

IMPORTANT! Module 1 (eLearning) must be completed before participating in this session.

Published: 2024-10-31

Length: 90 minutes

Start the training:

Employee link: Grow@Lenovo

Course code: DSRT0102

3. **Partner Technical Webinar - OneIQ**

2024-07-15 | 60 minutes | Employees and Partners

In this 60-minute replay, Peter Grant, Field CTO for OneIQ, reviewed and demo'd the capabilities of OneIQ including collecting data and analyzing. Additionally, Peter and the team discussed how specific partners (those with NA Channel SA coverage) will get direct access to OneIQ and other partners can get access to OneIQ via Distribution or the NA LETS team.

Published: 2024-07-15

Length: 60 minutes

Start the training:

Employee link: Grow@Lenovo

Partner link: [Lenovo Partner Learning](#)

Course code: 071224

4. **SAP Webinar for Lenovo Sellers: Lenovo Portfolio Update for SAP Landscapes**

2024-06-04 | 60 minutes | Employees Only

Join Mark Kelly, Advisory IT Architect with the Lenovo Global SAP Center of Competence as he discusses:

- Challenges in the SAP environment
- Lenovo On-premise Solutions for SAP
- Lenovo support resources for SAP solutions

Published: 2024-06-04

Length: 60 minutes

Start the training:

Employee link: [Grow@Lenovo](#)

Course code: DSAPF101

5. **Lenovo Data Center Product Portfolio**

2024-05-29 | 20 minutes | Employees and Partners

This course introduces the Lenovo data center portfolio, and covers servers, storage, storage networking, and software-defined infrastructure products. After completing this course about Lenovo data center products, you will be able to identify product types within each data center family, describe Lenovo innovations that this product family or category uses, and recognize when a specific product should be selected.

Published: 2024-05-29

Length: 20 minutes

Start the training:

Employee link: [Grow@Lenovo](#)

Partner link: [Lenovo Partner Learning](#)

Course code: SXXW1110r7

6. **VTT Cloud Architecture: NVIDIA Using Cloud for GPUs and AI**

2024-05-22 | 60 minutes | Employees Only

Join JD Dupont, NVIDIA Head of Americas Sales, Lenovo partnership and Veer Mehta, NVIDIA Solution Architect on an interactive discussion about cloud to edge, designing cloud Solutions with NVIDIA GPUs and minimizing private\hybrid cloud OPEX with GPUs. Discover how you can use what is done at big public cloud providers for your customers. We will also walk through use cases and see a demo you can use to help your customers.

Published: 2024-05-22

Length: 60 minutes

Start the training:

Employee link: [Grow@Lenovo](#)

Course code: DVCLD212

7. **Partner Technical Webinar - ISG Portfolio Update**

2024-04-15 | 60 minutes | Employees and Partners

In this 60-minute replay, Mark Bica, NA ISG Server Product Manager reviewed the Lenovo ISG portfolio. He covered new editions such as the SR680a \ SR685a, dense servers, and options that are strategic for any workload.

Published: 2024-04-15

Length: 60 minutes

Start the training:

Employee link: [Grow@Lenovo](#)

Partner link: [Lenovo Partner Learning](#)

Course code: 041224

8. **Partner Technical Webinar – StorMagic**

2024-03-19 | 60 minutes | Employees and Partners

March 08, 2024 – In this 60-minute replay, Stuart Campbell and Wes Ganeko of StorMagic joined us and provided an overview of StorMagic on Lenovo. They also demonstrated the interface while sharing some interesting use cases.

Published: 2024-03-19

Length: 60 minutes

Start the training:

Employee link: [Grow@Lenovo](#)

Partner link: [Lenovo Partner Learning](#)

Course code: 030824

9. **Family Portfolio: Storage Controller Options**

2024-01-23 | 25 minutes | Employees and Partners

This course covers the storage controller options available for use in Lenovo servers. The classes of storage controller are discussed, along with a discussion of where they are used, and which to choose.

After completing this course, you will be able to:

- Describe the classes of storage controllers
- Discuss where each controller class is used
- Describe the available options in each controller class

Published: 2024-01-23

Length: 25 minutes

Start the training:

Employee link: [Grow@Lenovo](#)

Partner link: [Lenovo Partner Learning](#)

Course code: SXXW1111

10. **Lenovo-Intel Sustainable Solutions QH**
2024-01-22 | 10 minutes | Employees and Partners

This Quick Hit explains how Lenovo and Intel are committed to sustainability, and introduces the Lenovo-Intel joint sustainability campaign. You will learn how to use this campaign to show customers what that level of commitment entails, how to use the campaign's unsolicited proposal approach, and how to use the campaign as a conversation starter which may lead to increased sales.

Published: 2024-01-22
Length: 10 minutes

Start the training:
Employee link: [Grow@Lenovo](#)
Partner link: [Lenovo Partner Learning](#)

Course code: SXXW2524a

11. **Family Introduction: Rack and Tower**
2024-01-19 | 11 minutes | Employees and Partners

This course is designed to give Lenovo sales and partner representatives a foundation on the characteristics of the rack and tower server family. As an introduction to the family, this course also includes positioning, when to use a product, and keywords a client may use when discussing a rack product.

Course Objectives:

- Family Characteristics
- Priority Positioning
- Product Usage
- Keywords and Phrases

Published: 2024-01-19
Length: 11 minutes

Start the training:
Employee link: [Grow@Lenovo](#)
Partner link: [Lenovo Partner Learning](#)

Course code: SXXW1100r3

12. **FY24Q3 Intel Servers Update**
2023-12-11 | 15 minutes | Employees and Partners

This update is designed to help you discuss the features and customer benefits of Lenovo servers that use the 5th Gen Intel® Xeon® processors. Lenovo has also introduced a new server, the ThinkSystem SD650-N V3, which expands the supercomputer server family. Reasons to call your customer and talk about refreshing their infrastructure are also included as a guideline.

Published: 2023-12-11
Length: 15 minutes

Start the training:
Employee link: [Grow@Lenovo](#)
Partner link: [Lenovo Partner Learning](#)

Course code: SXXW2522a

13. **Partner Technical Webinar - Cloudian - Ransomware**
2023-10-12 | 60 minutes | Employees and Partners

In this 60-minute replay, Tim O’Neal, Eric Craig, and Charlii Collins of Cloudian discuss how Cloudian protects from Ransomware paired with VEEAM, Commvault, or Rubrik.

Published: 2023-10-12
Length: 60 minutes

Start the training:
Employee link: [Grow@Lenovo](#)
Partner link: [Lenovo Partner Learning](#)

Course code: 100623

14. **VTT: SAP HANA Transition and Refresh Opportunity - July 2023**
2023-07-14 | 60 minutes | Employees Only

In this session, we cover:
- What Next for SAP Clients?
- Lenovo Opportunity
- Lenovo Portfolio for SAP Solutions
- RISE with SAP

Published: 2023-07-14
Length: 60 minutes

Start the training:
Employee link: [Grow@Lenovo](#)

Course code: DVDAT202

15. **Partner Technical Webinar - Data Center Limits and ISG TAA Compliance**
2023-05-16 | 60 minutes | Employees and Partners

In this 60-minute replay, we had two topics. First Vinod Kamath, Lenovo Distinguished Engineer for Data Center Cooling presented on the Systems Configuration and Data Center Ambient Limits. Second, Shama Patari, Lenovo Trade Council, and Glenn Johnson, Lenovo Principal Engineer for Supply Chain presented on ISG TAA Compliance.

Published: 2023-05-16
Length: 60 minutes

Start the training:
Employee link: [Grow@Lenovo](#)
Partner link: [Lenovo Partner Learning](#)

Course code: 051223

16. **Introduction to the Intel Xeon Scalable Gen4 Processors**

2022-12-30 | 10 minutes | Employees and Partners

When you complete this course, you should be able to define the Gen4 Intel Xeon Scalable processors and the four tiers used in the family. You should also be able to discuss the new features of the Gen4 processors and the family value proposition.

Published: 2022-12-30

Length: 10 minutes

Start the training:

Employee link: [Grow@Lenovo](#)

Partner link: [Lenovo Partner Learning](#)

Course code: SXXW2500

17. **Technical Champions Webinar: ThinkSystem V3 Servers using Intel Eagle Stream**

2022-12-08 | 86 minutes | Employees Only

This webinar discusses the key new features of the Intel Eagle Stream platform and its implementation in the ThinkSystem Server portfolio. This webinar will cover what has changed from the previous generation of servers, and timeframes for availability.

Published: 2022-12-08

Length: 86 minutes

Start the training:

Employee link: [Grow@Lenovo](#)

Course code: DTSP201

18. **Lenovo Infrastructure Solutions Launch**

2022-09-16 | 8 minutes | Employees and Partners

This Quick Hit introduces a wealth of new products, solutions, and services announced as part of the Lenovo ThinkSystem 30th Anniversary celebration.

Published: 2022-09-16

Length: 8 minutes

Start the training:

Employee link: [Grow@Lenovo](#)

Partner link: [Lenovo Partner Learning](#)

Course code: FY23Q2a

19. **Lenovo Sustainable Computing**

2022-09-16 | 4 minutes | Employees and Partners

This Quick Hit describes the Lenovo sustainable computing program, and the many ways in which Lenovo strives to respect and protect the environment.

Published: 2022-09-16

Length: 4 minutes

Start the training:

Employee link: [Grow@Lenovo](#)

Partner link: [Lenovo Partner Learning](#)

Course code: SXXW2504a

20. Introduction to DDR5 Memory

2022-08-23 | 10 minutes | Employees and Partners

This course introduces DDR5 memory, describes new features of this memory generation, and discusses the advantages to customers of this new memory generation.

Published: 2022-08-23

Length: 10 minutes

Start the training:

Employee link: [Grow@Lenovo](#)

Partner link: [Lenovo Partner Learning](#)

Course code: SXXW2502

Related publications and links

For more information, see these resources:

- ThinkSystem SR650 V3 product page:
<https://www.lenovo.com/us/en/p/racks/len21ts0013>
- ThinkSystem SR650 V3 datasheet
<https://lenovopress.com/ds0143>
- Interactive 3D Tour of the ThinkSystem SR650 V3:
<https://lenovopress.lenovo.com/lp1621-thinksystem-sr650-v3-interactive-3d-tour>
- ThinkSystem SR650 V3 drivers and support
<http://datacentersupport.lenovo.com/products/servers/thinksystem/sr650v3/7d76/downloads>
- Lenovo Hardware Installation & Removal Videos on the SR650 V3:
<https://www.youtube.com/playlist?list=PLYV5R7hVcs-BmyijyY0-INvapM4fTV5Gf>
- Lenovo ThinkSystem SR650 V3 product publications:
<https://pubs.lenovo.com/sr650-v3/>
 - User Guide, which includes:
 - System Configuration Guide
 - Hardware Maintenance Guide
 - Rack Installation Guides
 - Messages and Codes Reference
 - UEFI Manual for ThinkSystem Servers
- User Guides for options:
<https://serveroption.lenovo.com>
- ServerProven hardware compatibility:
<http://serverproven.lenovo.com>

Related product families

Product families related to this document are the following:

- [2-Socket Rack Servers](#)
- [ThinkSystem SR650 V3 Server](#)

Notices

Lenovo may not offer the products, services, or features discussed in this document in all countries. Consult your local Lenovo representative for information on the products and services currently available in your area. Any reference to a Lenovo product, program, or service is not intended to state or imply that only that Lenovo product, program, or service may be used. Any functionally equivalent product, program, or service that does not infringe any Lenovo intellectual property right may be used instead. However, it is the user's responsibility to evaluate and verify the operation of any other product, program, or service. Lenovo may have patents or pending patent applications covering subject matter described in this document. The furnishing of this document does not give you any license to these patents. You can send license inquiries, in writing, to:

Lenovo (United States), Inc.
8001 Development Drive
Morrisville, NC 27560
U.S.A.
Attention: Lenovo Director of Licensing

LENOVO PROVIDES THIS PUBLICATION "AS IS" WITHOUT WARRANTY OF ANY KIND, EITHER EXPRESS OR IMPLIED, INCLUDING, BUT NOT LIMITED TO, THE IMPLIED WARRANTIES OF NON-INFRINGEMENT, MERCHANTABILITY OR FITNESS FOR A PARTICULAR PURPOSE. Some jurisdictions do not allow disclaimer of express or implied warranties in certain transactions, therefore, this statement may not apply to you.

This information could include technical inaccuracies or typographical errors. Changes are periodically made to the information herein; these changes will be incorporated in new editions of the publication. Lenovo may make improvements and/or changes in the product(s) and/or the program(s) described in this publication at any time without notice.

The products described in this document are not intended for use in implantation or other life support applications where malfunction may result in injury or death to persons. The information contained in this document does not affect or change Lenovo product specifications or warranties. Nothing in this document shall operate as an express or implied license or indemnity under the intellectual property rights of Lenovo or third parties. All information contained in this document was obtained in specific environments and is presented as an illustration. The result obtained in other operating environments may vary. Lenovo may use or distribute any of the information you supply in any way it believes appropriate without incurring any obligation to you.

Any references in this publication to non-Lenovo Web sites are provided for convenience only and do not in any manner serve as an endorsement of those Web sites. The materials at those Web sites are not part of the materials for this Lenovo product, and use of those Web sites is at your own risk. Any performance data contained herein was determined in a controlled environment. Therefore, the result obtained in other operating environments may vary significantly. Some measurements may have been made on development-level systems and there is no guarantee that these measurements will be the same on generally available systems. Furthermore, some measurements may have been estimated through extrapolation. Actual results may vary. Users of this document should verify the applicable data for their specific environment.

© Copyright Lenovo 2024. All rights reserved.

This document, LP1601, was created or updated on October 29, 2024.

Send us your comments in one of the following ways:

- Use the online Contact us review form found at:
<https://lenovopress.lenovo.com/LP1601>
- Send your comments in an e-mail to:
comments@lenovopress.com

This document is available online at <https://lenovopress.lenovo.com/LP1601>.

Trademarks

Lenovo and the Lenovo logo are trademarks or registered trademarks of Lenovo in the United States, other countries, or both. A current list of Lenovo trademarks is available on the Web at <https://www.lenovo.com/us/en/legal/copytrade/>.

The following terms are trademarks of Lenovo in the United States, other countries, or both:

Lenovo®
AnyBay®
Neptune®
ServerProven®
System x®
ThinkAgile®
ThinkEdge®
ThinkServer®
ThinkShield®
ThinkSystem®
XClarity®

The following terms are trademarks of other companies:

AMD and AMD Instinct™ are trademarks of Advanced Micro Devices, Inc.

Intel®, Intel Optane®, and Xeon® are trademarks of Intel Corporation or its subsidiaries.

Linux® is the trademark of Linus Torvalds in the U.S. and other countries.

Microsoft®, ActiveX®, Hyper-V®, PowerShell, Windows PowerShell®, Windows Server®, and Windows® are trademarks of Microsoft Corporation in the United States, other countries, or both.

SPECpower® is a trademark of the Standard Performance Evaluation Corporation (SPEC).

Other company, product, or service names may be trademarks or service marks of others.